

# LPOW-2415A Power Supply for LIOB Connect Devices

## Installation instructions

Instructions de montage

Montageanweisung

Montagevoorschrift

Istruzioni di montaggio

Instrucciones de montaje

Monteringsanvisning

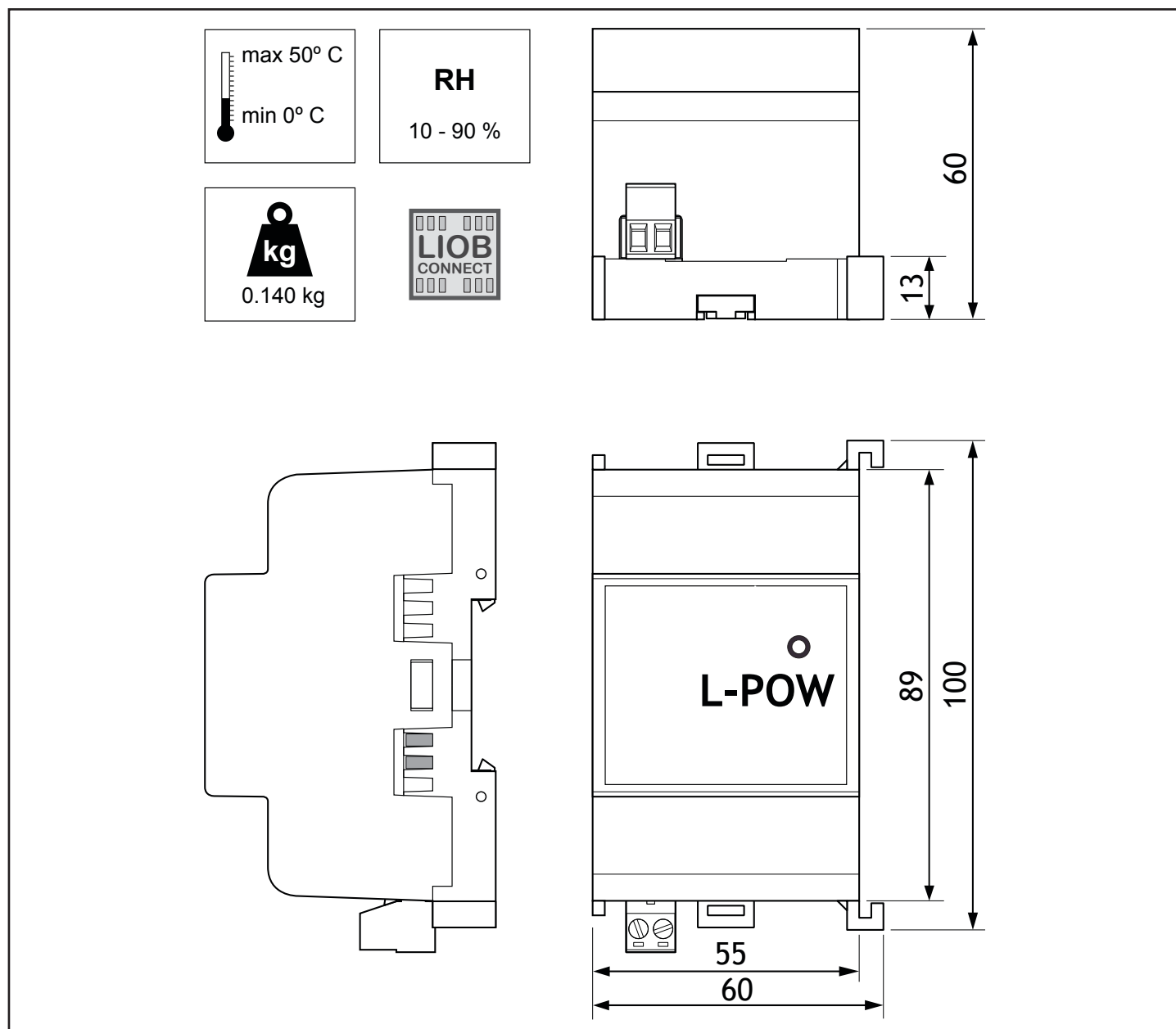

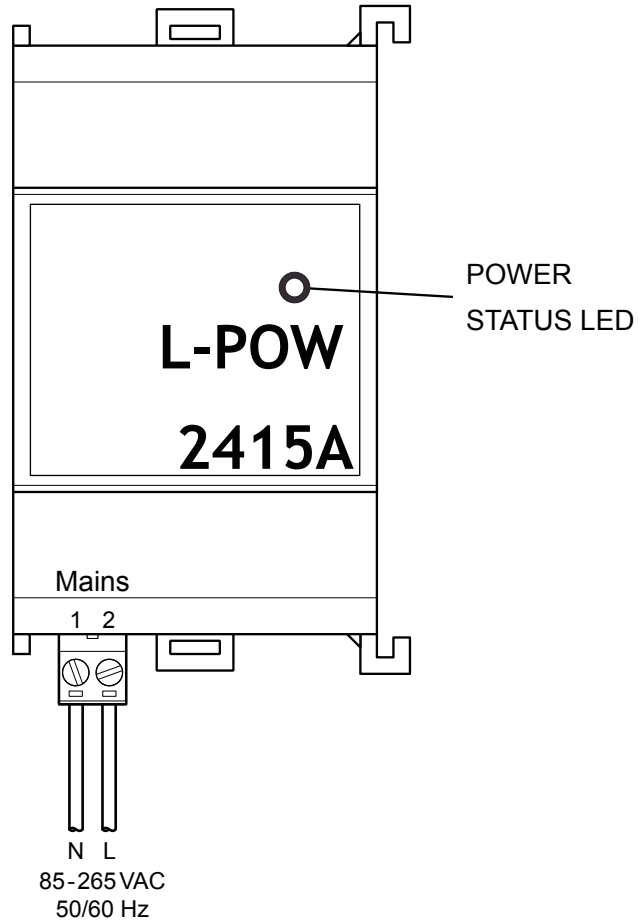
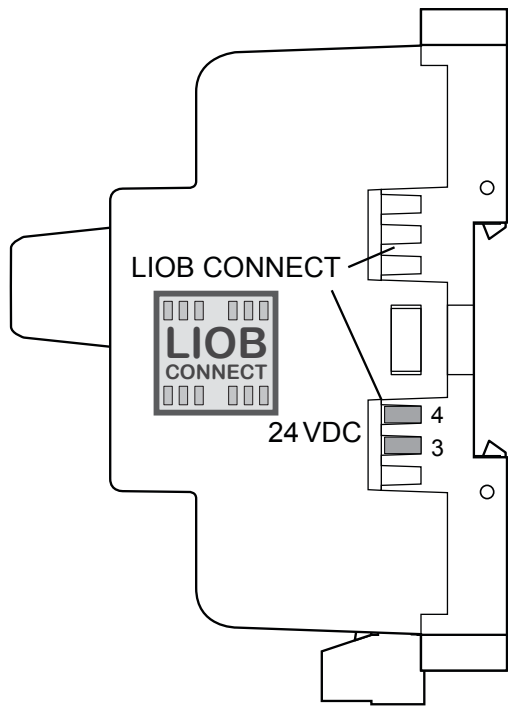

Connectors		
POWER INPUT 85-265 VAC 50 / 60 Hz	1	Input N, neutral line
	2	Input L, phase line
OUTPUT 24 VDC max. 15 W (625 mA)	3	Output GND
	4	Output PLUS

Status LED		
POWER	GREEN	Power supply OK
	LED is OFF	Main side is down, short circuit, or hardware failure

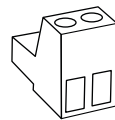

2 poles: Weidmüller BLZP 5.08/02/180

0.2 - 2.5 mm<sup>2</sup>

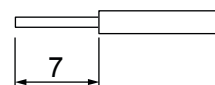

max. 4 L-IOB devices

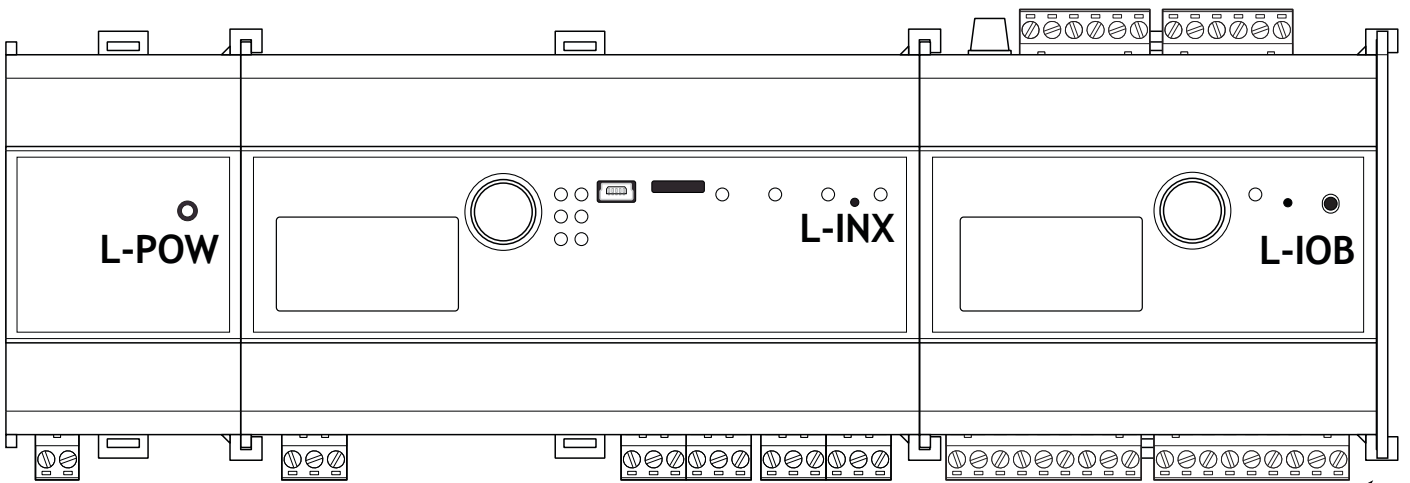

Install the cover on last device

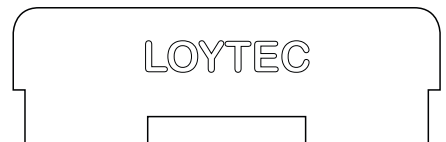

35 mm x 7.5 mm DIN rail (EN 50022, BS 5584, DIN 46277-3)

