

---

# L-DALI™

DALI Light Controller

## User Manual

LOYTEC electronics GmbH



Contact

LOYTEC  
Blumengasse 35  
A-1170 Vienna  
AUSTRIA/EUROPE  
support@loytec.com  
<http://www.loytec.com>

Version 6.0

Document 88077111

LOYTEC MAKES AND YOU RECEIVE NO WARRANTIES OR CONDITIONS,  
EXPRESS, IMPLIED, STATUTORY OR IN ANY COMMUNICATION WITH YOU,  
AND

LOYTEC SPECIFICALLY DISCLAIMS ANY IMPLIED WARRANTY OF  
MERCHANTABILITY OR FITNESS FOR A PARTICULAR PURPOSE. THIS  
PRODUCT IS NOT DESIGNED OR INTENDED FOR USE IN EQUIPMENT  
INTENDED FOR SURGICAL IMPLANT INTO THE BODY OR OTHER  
APPLICATIONS INTENDED TO SUPPORT OR SUSTAIN LIFE, FOR USE IN  
FLIGHT CONTROL OR ENGINE CONTROL EQUIPMENT WITHIN AN  
AIRCRAFT, OR FOR ANY OTHER APPLICATION IN WHICH IN THE FAILURE  
OF SUCH PRODUCT COULD CREATE A SITUATION IN WHICH PERSONAL  
INJURY OR DEATH MAY OCCUR. LOYTEC MAKES NO REPRESENTATION  
AND OFFERS NO WARRANTY OF ANY KIND REGARDING OF ANY  
THIRDPARTY COMPONENTS MENTIONED IN THIS MANUAL.

No part of this publication may be reproduced, stored in a retrieval system, or transmitted,  
in any form or by any means, electronic, mechanical, photocopying, recording, or otherwise,  
without the prior written permission of LOYTEC.

LC3020™, L-Chip™, L-Core™, L-DALI™, L-GATE™, L-INX™, L-IOB™,  
LIOB-Connect™, LIOB-FT™, L-IP™, LPA™, L-Proxy™, L-Switch™, L-Term™,  
L-VIS™, L-WEB™, L-ZIBI™, ORION™ stack and Smart Auto-Connect™ are  
trademarks of LOYTEC electronics GmbH.

LonTalk®, LONWORKS®, Neuron®, LONMARK®, LonMaker®, *i.LON*®, and LNS® are  
trademarks of Echelon Corporation registered in the United States and other countries.

## Contents

<b>1</b>	<b>Introduction .....</b>	<b>9</b>
1.1	Overview .....	9
1.2	L-DALI Models .....	13
1.3	Scope.....	13
<b>2</b>	<b>What's New in L-DALI.....</b>	<b>15</b>
2.1	New in L-DALI 6.0.....	15
2.2	New in L-DALI 5.3.....	18
2.3	New in L-DALI 5.2.....	18
2.4	New in L-DALI 3.2.....	21
<b>3</b>	<b>Quick-Start Guide .....</b>	<b>23</b>
3.1	<b>Hardware Installation.....</b>	<b>23</b>
3.1.1	Models without built-in DALI Bus Power Supply .....	23
3.1.2	Models with built-in DALI Bus Power Supply .....	24
3.2	<b>Test proper wiring of DALI devices .....</b>	<b>25</b>
3.2.1	Models without LCD display .....	25
3.2.2	Models with LCD display .....	25
3.3	<b>Device configuration .....</b>	<b>26</b>
3.4	<b>Configuration of IP Address .....</b>	<b>26</b>
3.4.1	IP Configuration via the LCD Display.....	26
3.4.2	IP Configuration via the Web Interface .....	27
3.4.3	IP Configuration via Console.....	29
3.5	<b>Configuration with PC Software .....</b>	<b>30</b>
3.5.1	Connect to Device in Stand-Alone Mode.....	31
3.5.2	Scan DALI Channel .....	31
3.5.3	Assign Lamps, Sensor and Button to LONMARK/BACnet Objects .....	32
3.5.4	Grouping Lamps .....	33
3.5.5	Parameterize the Constant Light Controller .....	34
3.5.6	Parameterize the DALI button .....	35
3.5.7	Download Configuration.....	35
3.5.8	Calibrate Light Sensor .....	36
3.6	<b>Configuration using Web Interface .....</b>	<b>37</b>
3.6.1	Scan DALI Channel .....	37
3.6.2	Assign Lamps, Sensor and Button to LONMARK/BACnet Objects .....	39
3.6.3	Grouping Lamps .....	39
3.6.4	Calibrate Light Sensor .....	40
3.6.5	Parameterize the DALI button .....	41

3.6.6	Parameterize the Constant Light Controller .....	41
<b>3.7</b>	<b>Configuration of BACnet Interface (LDALI-20X only).....</b>	<b>42</b>
3.7.1	Configure BACnet Interface.....	42
<b>4</b>	<b>Hardware Installation.....</b>	<b>44</b>
<b>4.1</b>	<b>Enclosure .....</b>	<b>44</b>
4.1.1	LDALI-3E10X-U and LDALI-ME20X-U.....	44
4.1.2	LDALI-E101-U, LDALI-3101-U and LDALI-E101-U.....	44
4.1.3	LDALI-3E10X and LDALI-ME204.....	45
<b>4.2</b>	<b>Product Label.....</b>	<b>46</b>
<b>4.3</b>	<b>Mounting .....</b>	<b>46</b>
<b>4.4</b>	<b>LED signals .....</b>	<b>46</b>
4.4.1	LDALI-3E10X-U and LDALI-ME20X-U.....	46
4.4.2	LDALI-3E10X and LDALI-ME204.....	48
4.4.3	LDALI-E101-U, LDALI-3101-U and LDALI-E101-U.....	49
4.4.4	Wink Action .....	50
<b>4.5</b>	<b>Buttons.....</b>	<b>50</b>
4.5.1	Status Button .....	50
4.5.2	DALI Mode Button .....	50
4.5.3	DALI Channel Button .....	51
4.5.4	DALI Program Button.....	51
<b>4.6</b>	<b>DIP Switch Settings .....</b>	<b>51</b>
<b>4.7</b>	<b>Wiring.....</b>	<b>52</b>
<b>5</b>	<b>Workflows for the L-DALI.....</b>	<b>53</b>
5.1.1	On-Line .....	53
5.1.2	Off-Line.....	54
5.1.3	Replace an L-DALI .....	55
5.1.4	Enable Legacy NM Mode (LDALI-10X only) .....	55
5.1.5	Configuration Upload and Download.....	56
<b>6</b>	<b>L-DALI Lighting Application .....</b>	<b>57</b>
<b>6.1</b>	<b>CEA-709 Interface and Application (LDALI-10X only) .....</b>	<b>57</b>
6.1.1	Lamp actuator Object #3040 .....	57
6.1.2	Light Sensor Object #1010.....	79
6.1.3	Occupancy Sensor Object #1060.....	81
6.1.4	Constant Light Controller Object #3050 .....	83
6.1.5	Sunblind Controller Object #6111.....	102
6.1.6	Globals #0005 .....	120
6.1.7	Button #0001 .....	127
<b>6.2</b>	<b>BACnet Interface and Application (LDALI-20X only) .....</b>	<b>129</b>
6.2.1	Interface Version .....	130

---

6.2.2	Light Output Objects.....	130
6.2.3	Sensor Objects .....	153
6.2.4	Constant Light Controller .....	157
6.2.5	Button Objects .....	168
<b>6.3</b>	<b>Web Interface .....</b>	<b>170</b>
6.3.1	Constant Light Controller Bindings (Commission).....	170
6.3.2	Debug (Config) .....	171
<b>7</b>	<b>Security Hardening Guide .....</b>	<b>174</b>
7.1	Installation Instructions.....	174
7.2	Firmware.....	174
7.3	Ports .....	174
7.4	Services.....	175
7.5	Logging and Auditing .....	175
<b>8</b>	<b>Specifications .....</b>	<b>176</b>
8.1	Physical Specifications .....	176
8.1.1	LDALI-3E10X-U/LDALI-ME20X-U.....	176
8.1.2	LDALI-3E10X/LDALI-ME204.....	176
8.1.3	LDALI-3101-U/LDALI-E101-U/LDALI-E201-U.....	177
8.2	Resource Limits .....	177
8.3	FCC Warning .....	178
8.4	CE Warning.....	178
<b>9</b>	<b>References .....</b>	<b>179</b>
<b>10</b>	<b>Revision History.....</b>	<b>180</b>



## Abbreviations

100BaseT .....	100 Mbps Ethernet network with RJ-45 plug
Aggregation.....	Collection of several CEA-709 packets into a single CEA-852 packet
AST .....	Alarming, Scheduling, Trending
BACnet .....	Building Automation and Control Network
BBMD.....	BACnet Broadcast Management Device
BDT .....	Broadcast Distribution Table
CA.....	Certification Authority
CC .....	Configuration Client, also known as CN/IP Device
CEA-709 .....	Protocol standard for LONWORKS networks
CEA-852 .....	Protocol standard for tunneling CEA-709 packets over IP channels
CN.....	Control Network
CN/IP .....	Control Network over IP
CN/IP Channel .....	logical IP channels that tunnels CEA-709 packets according CEA-852
CN/IP packet.....	IP packet that tunnels one or multiple CEA-709 packet(s)
COV .....	change-of-value
CR .....	Channel Routing
CS.....	Configuration Server that manages CEA-852 IP devices
DA.....	Data Access
DALI.....	Digital Addressable Lighting Interface, see IEC 62386
DHCP.....	Dynamic Host Configuration Protocol, RFC 2131, RFC 2132
DL .....	Data Logger, Datenlogger (Webservice)
DNS .....	Domain Name Server, RFC 1034
DST .....	Daylight Saving Time
GMT.....	Greenwich Mean Time
IP.....	Internet Protocol
LSD Tool .....	LOYTEC System Diagnostics Tool
IP-852.....	Logical IP-Channel, for tunneling CEA-709 packets according to CEA-852
LAN .....	Local Area Network
LSD Tool .....	LOYTEC System Diagnostics Tool
MAC .....	Media Access Control
MD5 .....	Message Digest 5, a secure hash function, see Internet RFC 1321
MS/TP.....	Master/Slave Token Passing (this is a BACnet data link layer)
NAT .....	Network Address Translation, see Internet RFC 1631
NV.....	Network Variable
OPC.....	Open Process Control
OPC UA .....	OPC Unified Architecture
PEM .....	Privacy Enhanced Mail
RNI.....	Remote Network Interface

RTT .....	Round-Trip Time
RTU .....	Remote Terminal Unit
SL .....	Send List
SMTP .....	Simple Mail Transfer Protocol
SNTP .....	Simple Network Time Protocol
SNVT .....	Standard Network Variable Type
SSH.....	Secure Shell
SSL.....	Secure Socket Layer
TLS.....	Transport Layer Security
UI.....	User Interface
UNVT.....	User-Defined Network Variable Type
UTC.....	Universal Time Coordinated
WLAN.....	Wireless LAN
XML .....	eXtensible Markup Language



# 1 Introduction

## 1.1 Overview

The L-DALI controllers for LONMARK and BACnet systems are DALI gateways with built-in light controller functionality.

DALI (Digital Addressable Lighting Interface) is defined in the international standard IEC 62386. It is used to dim and switch luminaries from most leading manufacturers. DALI also supports devices like multi-sensors (e.g. for brightness, occupancy, etc.) and intelligent switches.

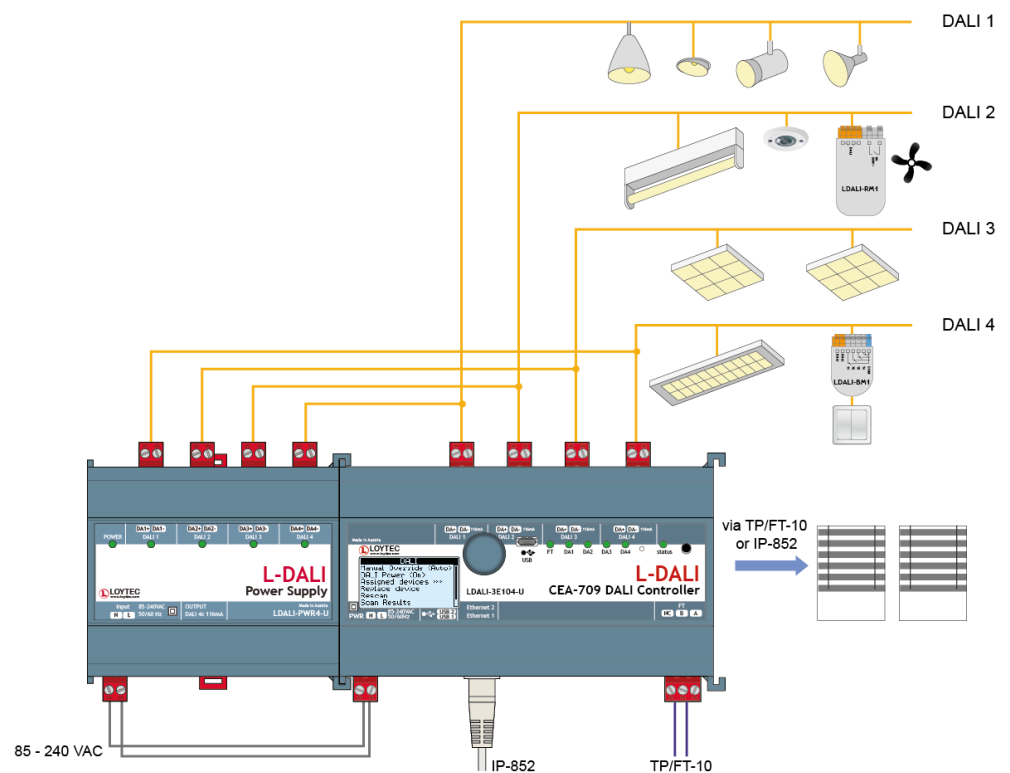

Figure 1: L-DALI supports up to four DALI channels.

The L-DALI lineup features 1, 2, or 4 independent DALI channels. Up to 64 DALI-based luminaires per DALI channel can be controlled individually or via 16 groups. All luminaires are monitored for lamp defect. L-DALI can provide this information to the Building Management System (BMS) through its NV or BACnet interface respectively. For

CEA-709 communication IP-852 (Ethernet/IP) and TP/FT-10 are supported, for BACnet communication BACnet/IP and BACnet MS/TP are supported.

LDALI-3E102-U, and LDALI-3E104-U, LDALI-3101-U, LDALI-E101-U, LDALI-3E102, and LDALI-3E104 are gateways connecting a DALI network to a CEA-709/LONMARK network, LDALI-ME202-U, LDALI-ME204-U, LDALI-ME204 and LDALI-E201-U are gateways connecting a DALI network to a BACnet network. On the DALI network the L-DALI controller represents a DALI master controller. On the CEA-709 or BACnet network the L-DALI controller offers a NV interface or a BACnet server objects respectively to control the ballasts and the sensors connected for the DALI network.

The constant light controller (LONMARK functional profile #3050, BACnet Loop object) allows controlling DALI ballasts with lighting nodes on the CEA-709 or BACnet network. Occupancy and lux-level sensors for constant light control and buttons for manual operation can be integrated via the CEA-709/BACnet interface or directly on the DALI side.

On the LONMARK version a built-in sunblind controller (LONMARK functional profile #6111) interacts with other nodes on the CEA-709 network. Interaction between the sunblind and constant light controller applications allows adjusting sunblinds depending on the constant light controller output, e.g. for energy saving concepts.

L-DALI supports automation functions such as alarming, scheduling, and trending. The L-DALI controllers offer local scheduling services including the possibility to configure several local and remote 24 hour schedulers through the Web UI. Alarming includes the functionality to generate, deliver, acknowledge, and display alarm conditions and logs regardless whether the condition comes from the DALI or the CEA-709/BACnet network. The trending capability includes periodic and event triggered data logging of values and time stamps. Alarms and trend data are stored on the device accessible via an FTP connection as CSV files.

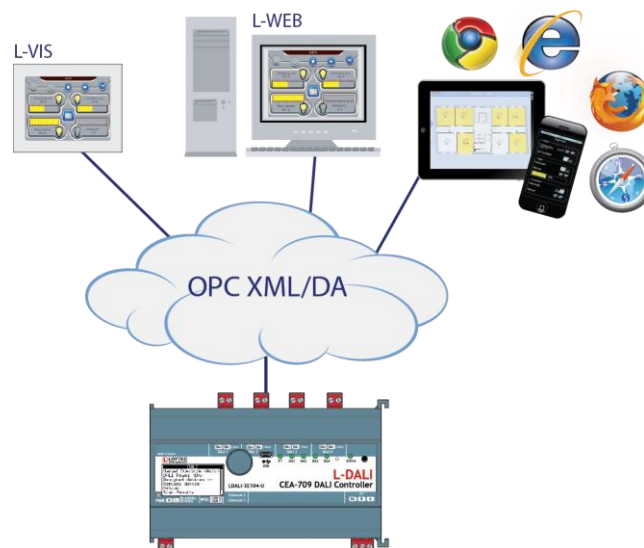

Figure 2: Using L-DALI together with the L-WEB product family.

L-DALI devices can be integrated with LWEB-802/803 visualization and LWEB-900 using OPC XML-DA. LWEB-802/803 and LWEB-900 can be used for visualization of an L-DALI based lighting control system. LWEB-900 offers additional functionality like saving trend and log files for long term storage, easy managing of remote schedulers and calendars, data analysis and report generation. L-DALI supports event-driven e-mail notification as a result of a predefined action triggered by a specific status or an exceeded

high limit. e-mail notification can also be used to forward trend and log files to central SQL databases for long term storage (see LWEB-900 for details).

L-DALI supports common mathematical operations and functions, as well as Boolean expressions.

Some lighting controller applications do not need a connection to the CEA-709 or BACnet network. Therefore the L-DALI controller can control a DALI network as a standalone device with the aid of the supported automation functions (alarming, scheduling, and trending). Connected to an IP network, remote access allows to set parameters and to read the system status.

The complete configuration can be done through the built-in Web server. The commissioning and maintenance of the DALI system can be done using a standard Web browser on a PC. The configuration can also be done via a PC based configuration software.

The L-DALI offers the following features:

- DALI gateway and controller
- Supports 1, 2, or 4 DALI channels (dependent on model)
- Direct control of up to 64 DALI devices per DALI channel
- Direct control of up to 16 DALI groups per DALI channel
- Scene control for up to 16 groups and one broadcast scene per DALI channel
- Detect lamp and ballast failure on DALI luminaries and signals
- Simple replacement of (broken) DALI devices (no configuration tool required)
- DALI Multi-Master capable
- Support for DALI sensors and buttons
- Built-in DALI protocol analyzer
- Alarming, Scheduling, and Trending (AST™)
- Common mathematical operations and functions as well as Boolean expressions
- Event-driven e-mail notification
- Periodic testing of emergency lights
- Lamp burn-in mode
- Calculation of energy consumption and run-hours
- OPC XML/DA (LWEB integration)
- Configuration via Web interface
- Firmware update via serial, CEA-709, or Ethernet port
- DIN rail mountable

LONMARK/CEA-709 models only:

- Fully compliant with CEA-709, CEA-852, and EN 14908 standard
- Supports LONMARK TP/FT-10 or CEA-852 Ethernet (IP-852) channels (selectable)
- Control of DALI capable ballasts via NVs
- Retrieve information from DALI capable sensors via NVs
- Supports LONMARK Functional Profiles:
  - Lamp Actuator #3040
  - Light Sensor #1010
  - Occupancy Sensor #1060
  - Constant Light Controller #3050
  - Sunblind Controller #6111
  - Scheduler #0007
  - Calendar #0006

BACnet models only:

- Fully compliant with BACnet standard ANSI/ASHRAE 135-2012
- BACnet/IP or BACnet MS/TP (selectable)
- Control of DALI capable ballasts and sensors via BACnet server objects
- Retrieve information from DALI capable sensors via BACnet server objects
- BACnet client functionality (configurable)
- Supports the following BACnet server objects:
  - Analog Output objects to control DALI ballasts, groups, and channels
  - Multi-State Output objects for scene control of DALI groups and channels
  - Analog Input objects providing feedback from DALI ballast, groups, and channels
  - Analog Input objects providing status information from DALI groups and channels
  - Accumulator objects providing estimated energy usage of DALI groups and channels

- Analog Input object providing lux level information from supported DALI sensors
- Binary Input objects providing occupancy information from supported DALI sensors
- Loop objects providing constant light controller functionality

## 1.2 L-DALI Models

This Section provides an overview of the different L-DALI models in Table 1. This table identifies the different features of the L-DALI models. Models that possess a certain feature have a check mark (✓) in the respective column. If a feature is not available in the particular model, the column is left blank.

Feature \ Model	Model										
	3E102	3E104	3101-U	E101-U	ME204	E201-U	3E101-U	3E102-U	3E104-U	ME201-U	ME204-U
DALI Power Supply			✓	✓		✓	✓			✓	
DALI Channels	2	4	1	1	4	1	1	2	4	1	4
DALI Emergency Lights Test	✓	✓	✓	✓	✓	✓	✓	✓	✓	✓	✓
Constant Light Controller	✓	✓	✓	✓	✓	✓	✓	✓	✓	✓	✓
Sunblind Controller	✓	✓	✓	✓			✓	✓	✓		
LCD Display with Jog Dial			✓	✓		✓	✓	✓	✓	✓	✓
LON TP/FT-10	✓	✓	✓				✓	✓	✓		
LON IP-852 (Ethernet/IP)	✓	✓		✓			✓	✓	✓		
BACnet MS/TP					✓					✓	✓
BACnet/IP (Ethernet/IP)					✓	✓				✓	✓
Configuration via WEB UI	✓	✓		✓	✓	✓	✓	✓	✓	✓	✓
Configuration via Software	✓	✓	✓	✓	✓	✓	✓	✓	✓	✓	✓
Console connector	✓	✓			✓						
LWEB-802/803 Hosting							✓	✓	✓	✓	✓
OPC XML-DA	✓	✓		✓	✓	✓	✓	✓	✓	✓	✓
OPC UA							✓	✓	✓	✓	✓
SSH, HTTPS, Firewall							✓	✓	✓	✓	✓
WLAN (with LWLAN-80x)							✓	✓	✓	✓	✓
Ethernet Switch/Hub				✓		✓	✓	✓	✓	✓	✓
EnOcean (with LENO-80x)							✓	✓	✓	✓	✓

Table 1: Available features in different L-DALI models.

**Important:** *In the following text models with BACnet interface are referred to as LDALI-20X and models with LONMARK/CEA-709 interface are referred to as LDALI-10X.*

## 1.3 Scope

This document covers L-DALI devices with firmware version 6.0 and the L-INX Configuration Software version 6.0. Basic device operations are covered in the LOYTEC

Device User Manual [1] and device configuration using the PC configuration software is covered by the LINX Configurator User Manual [2].

# 2 What's New in L-DALI

---

## 2.1 New in L-DALI 6.0

### New User Manual Structure

The L-DALI User Manual has been split up into three parts: The L-DALI User Manual, which now covers the specific functions of the L-DALI device models. The LINX Configurator User Manual is a common description for using the Configurator software for the L-INX, L-GATE, L-ROC, L-IOB, and L-DALI product line. And the LOYTEC Device User Manual covers hardware, Web interface, LCD display and operating interfaces topics common to all LOYTEC devices.

### New L-DALI Models

A new generation of L-DALI models replaces the existing models. The LDALI-ME20x-U replaces the LDALI-ME204 and LDALI-E201-U, while the LDALI-3E10x-U models replace the LDALI-3E104, LDALI-3E102, LDALI-E101-U and LDALI-3101-U models respectively. The new generation offers a higher performance and has more resources available. It therefore allows to host LWEB-802/803 projects directly on the device. Furthermore, it comes with a number of interfaces (USB, LIOB-Connect), which allows extending the capabilities of the device by connecting different peripherals directly to the controller, e.g. LENO-80x modules add EnOcean, while the LWLAN-800 module provides Wi-Fi connectivity.

### Constant Light Controller Improvements

The constant light controller application was extended by some new functions:

- The constant light controller can be reactivated from manual override by recalling a special scene on a linked group.
- A new data point – *nvoOccupState* (CEA-709/LDALI-10X) or *Occupancy\_State* (BACnet/LDALI-20X) – shows the current occupancy state as calculated by the constant light controller application.
- Two new data points – *Override* and *Auto\_Mode* – were added to the constant light controller BACnet interface (LDALI-20X) to provide similar functionality as via the CEA-709/LONMARK interface (LDALI-10X).

### New DALI Button Functions

The state of a button device input can now be forwarded to a BACnet Binary Input object as an alternative to directly control DALI lights on LDALI-20x models, too (see Section 6.2.5).

## DALI Status CSV-File

A new file on the device provides the current status of the devices on the DALI channel in CSV file format. The file is dynamically generated when read and therefore always reflects the most recent status of all devices. It can be downloaded from the device (e.g. via FTP) or sent as an e-mail attachment. In addition to detailed status and error information on every ballast, the file contains test results and battery status for the DALI emergency lights on the channel.

## DALI Protocol Analyzer

A DALI protocol analyzer was added to the LINX Configurator and the devices web-UI. In the LINX Configurator the protocol analyzer is available via the DALI Installation tab, while on the web-UI it is available via the DALI statistics Web interface. Logging can be started and stopped. Filters allow showing only relevant traffic. Protocol logs can be stored in a disk file in CSV format.

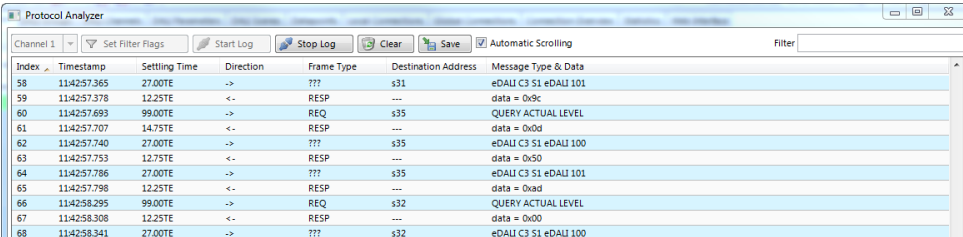

Index	Timestamp	Settling Time	Direction	Frame Type	Destination Address	Message Type & Data
58	1142:57:365	27.00TE	->	???	s31	eDALI C3 S1 eDALI 101
59	1142:57:378	12.25TE	<-	RESP	---	data = 0x0c
60	1142:57:693	99.00TE	->	REQ	s35	QUERY ACTUAL LEVEL
61	1142:57:707	14.75TE	<-	RESP	---	data = 0x0d
62	1142:57:740	27.00TE	->	???	s35	eDALI C3 S1 eDALI 100
63	1142:57:753	12.75TE	<-	RESP	---	data = 0x50
64	1142:57:786	27.00TE	->	???	s35	eDALI C3 S1 eDALI 101
65	1142:57:798	12.25TE	<-	RESP	---	data = 0xad
66	1142:58:295	99.00TE	->	REQ	s32	QUERY ACTUAL LEVEL
67	1142:58:308	12.25TE	<-	RESP	---	data = 0x00
68	1142:58:341	27.00TE	->	???	s32	eDALI C3 S1 eDALI 100

Figure 3: LINX Configurator DALI protocol analyzer window.

## DALI Scene Tab in LINX Configurator

DALI scene configuration tab was added to the LINX Configurator. Similar to the DALI scene web-UI introduced in L-DALI firmware version 5.2 it also supports colour scenes with colour temperature and changeable light colour. Scenes can be configured online and offline.



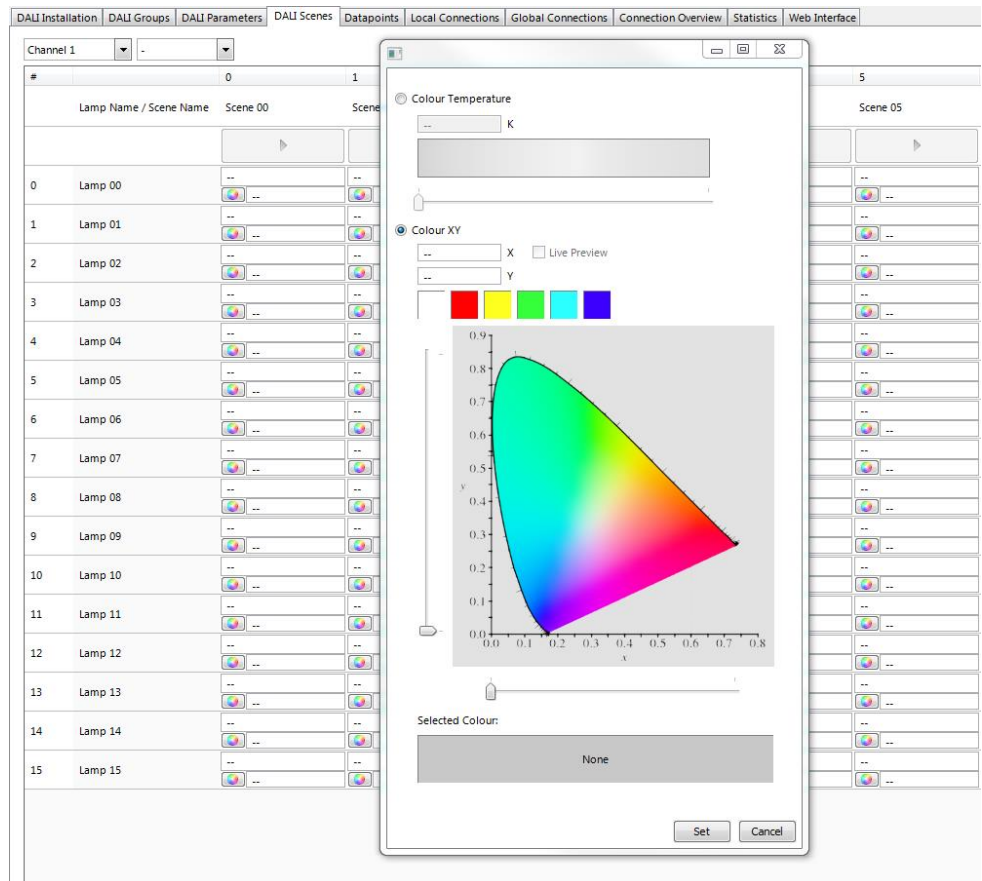

Figure 4: LINX Configurator DALI scene configuration.

### DALI Physical Selection Workflow support in LINX Configurator

Identification of a DALI sensor or DALI button device via physical selection is now also possible via the LINX Configurator software.

### Override Function for Data Points

The data point model in LOYTEC devices has been extended with a manual override function. On the Web interface and on the LCD display data point values can be overridden to manual values. If an override value is set, the running control logic no longer affects the data point value, neither does network communication. The override value is in effect until it is removed again by the user.

Data Point Details	
Path	/CEA709 DALI Channel 1/Datapoints/Group Actuators/Group Actuator 0/nviGPValue
Name	nviGPValue
Description	Used to set up value of the group
Direction	input
Type	analog
Value	100 % <input type="button" value="Set"/> <input type="button" value="Set override"/> <input type="button" value="Clear override"/>
Raw value	00 00 59 40 00 00 00 00 <input type="button" value="Set"/> <input type="button" value="Set override"/> <input type="button" value="Clear override"/>
Timestamp	2016-03-02 11:17:23+01:00
State	overridden (0x880a0001)

Figure 5: Overriding a data point on the Web interface.

Manual overrides done on the DALI Installation web-UI (for the channel) or the DALI Groups web-UI result in an override of all the data point which can be used to control any

lights on the channel or group respectively (Lamp Actuators, Group Actuators, Channel Actuators).

### **Enhanced Structure Support on the Web UI**

The display of data point structures has been improved on the Web UI. The data point listing shows a textual short version of the structured value instead of a hexadecimal Byte buffer. Also CEA-709 structures of NVs without sub-data points are displayed and can be edited.

---

## **2.2 New in L-DALI 5.3**

### **Print L-DALI Configuration**

The complete configuration of a L-DALI device including all DALI specific configuration data can now be printed using the Print function of the LINX Configurator. The Print option allows selecting, which parts of the configuration shall be included in the output. The output format can be either HTML or PDF.

### **New DALI Button Functions**

The functions, which can be executed when pressing a DALI button was extended by the function **Auto**. This will reactivate the constant light controller linked to the functions target group in case it was manually overridden.

---

## **2.3 New in L-DALI 5.2**

### **LINX Configurator replaces LDALI Configurator**

The L-DALI models are now supported by the LINX Configurator PC software. The LDALI Configurator software therefore is no longer available.

### **LINX Configurator support for LDALI-20X models**

The LINX Configurator now supports LDALI-20X models, including DALI offline configuration workflow and the configuration of alarming, scheduling and trend log objects, e-mail templates, math objects, data point connections etc. Custom user registers and BACnet objects can be created and data points belonging to the static L-DALI application interface can be OPC exposed. Further, the BACnet network can be scanned and client maps can be created from local BACnet objects to remote BACnet objects.

### **Support for LOYTEC LDALI-MS1, LDALI-BM1 and LDALI-RM1**

The L-DALI now supports the LDALI-MS1 multi-sensor, the LDALI-BM1 push-button coupler and the LDALI-RM1 relay module. These devices are an optimal addition to the L-DALI controller and allow designing cost effective and flexible DALI lighting systems. For more information on these devices see the corresponding datasheet and the LOYTEC Device User Manual [1].

### **DALI Button Functions**

For DALI button devices supporting configurable button functions these functions can be configured using the Web-UI (online) and the LINX Configurator (online and offline). The following functions are available to control DALI groups (see LOYTEC Device User Manual [1] and LINX Configurator User Manual [2]):

- Dim up, dim down,
- Off,
- On with last dimming value,
- Scene recall: 1–15,
- Dim to a specified value in %,
- Color temperature warmer/colder.

On LDALI-10X models the state of a button device input can be forwarded to a network variable as an alternative to directly control DALI lights (see Section 6.1.7.1).

### **DALI Scene Configuration**

A new page was added to the L-DALI Web-UI allowing configuration of DALI scenes (see LOYTEC Device User Manual [1]). Scene configuration also supports colour scenes with colour temperature and changeable light colour.

### **DALI Installation Wizards**

A DALI search wizard was added to the DALI installation Web-UI to quickly locate and assign DALI devices. When preconfiguring DALI devices in an offline workflow (name, group assignment, DALI parameters etc.) the wizard assists in locating the corresponding physical device once online (see LOYTEC Device User Manual [1]).

On the Constant Light Controller Web-UI a sensor search wizard was added. Once groups were configured to a CLC instance this wizard allows to automatically search for corresponding DALI sensors in the areas lit by these groups (see Section 6.3.1).

### **Identification of DALI Devices using Physical Selection**

Devices which can be physically selected can be identified by selection during the installation and commissioning process of the DALI network. A DALI button can be selected by pressing one of the buttons, an occupancy sensor can be selected by triggering occupancy. Now the last physically selected device is marked in the DALI scan results on the DALI Installation Web-UI and can be therefore identified.

### **Online Commissioning**

The Web interface of the device now provides an online commissioning tool for the respective networking technologies. Using this tool, data point configurations can be created based on placeholder devices, which are marked to be commissioned later. The necessary addressing information can be assigned later on the Web interface by scanning for devices online or be entered manually. Device replacement is also possible in the commissioning Web interface without the need to edit devices in the data point configuration. For more information on the commissioning Web UI please refer to the LOYTEC Device User Manual [1].

### **Web Interface**

The Web interface of the device offers a number of new features:

- A new device info page provides a quick overview of all relevant operational parameters, such as CPU load, active protocols, time synchronization and many more.

- The trend log configuration on the Web UI now also provides a preview tab, which shows a chart of the trend log data. The trend chart allows zoom, scrolling and hiding specific data curves, as shown in Figure 6.



Figure 6: New trend chart on the Web UI

- An improved DALI sensor calibration Web-UI allows to dim DALI groups directly from the sensor calibration Web-UI page making it easier to adjust the artificial light near the calibrated sensor. Further the calibration page can be accessed directly from the CLC Bindings page.

## Scheduler

The scheduler objects have been extended by the following new features:

- Color support in BACnet and generic schedulers allows consistent assignment and display of preset colors in L-WEB, L-VIS and the Configurator scheduler UIs.
- Event auto-prune removes passed events, if the capacity of exception events in a scheduler gets low.
- The scheduler default for LONMARK and generic schedulers is extended by a “silent” mode. In this mode the scheduler becomes inactive as soon as the last event is withdrawn. This mode can be used in event-driven scheduler models.
- Generic schedulers allow specifying an existing value preset as the schedule default. LONMARK and BACnet schedulers try identifying a matching preset name from the schedule default value.

## Format Strings in E-Mails

Data point variables used in e-mail templates can now use format strings to specify their numeric appearance in the e-mail text.

### Storing Project Documentation directly on the Device

A new page on the L-DALI Web-UI allows uploading project documentation and setting-up links to external documentation files (see LOYTEC Device User Manual [1]). Storing documentation directly on the device ensures its availability (e.g. for a service technician) later on.

---

## 2.4 New in L-DALI 3.2

This section describes the major changes and new features. For a full list of changes refer to the Readme file.

### New Constant Light Controller Modes

The constant light controller application offers some new Modes:

- The modes CONTROL, REGULATOR and PRESENCE are now available in variations with the extension AUTO. In these modes any active override will be automatically relinquished when the room enters “unoccupied” state. This allows to reactivate automatic mode when the room is unoccupied. The light will be switched off and – if necessary – switched on when someone enters the room.
- As a special variation of the AUTO modes, modes with the extension BEDROOM are available. In this mode the manual override is only relinquished when the lights are switched on. This ensures lights are switched off when the room is unoccupied, but stay off when commanded to off manually.
- The mode AMBIENT allows switching on and off lights depending on the measured lux level. It is therefore suitable for decorative lighting (facade illumination, shop window lighting, floor lighting, etc.).

The modes CONTROL and REGULATOR (incl. all variations) now consider the configured Unoccupied Level when switching off, similar to the mode PRESENCE. This allows dimming down to a configured level when the room is unoccupied instead of switching off. Typical applications are a reception area or similar areas where the light is never turned off completely.

---

*Note:* If the an LDALI-10X device was not shipped with firmware 3.2 the new modes are only available after the datapoint configuration was up- and downloaded again using the LINX Configurator.

---

Further information on the constant light controller modes can be found in Sections 6.1.4.3 and 6.2.4.3 and for the behavior when switching off in Sections 6.1.4.8 and 6.2.4.8.

### Overriding the Constant Light Control with DALI Buttons

When using internal manual bindings the constant light controller now detects when one of the groups it controls is dimmed by another DALI master. Such an override is interpreted similar to an override using the CEA-709/LONMARK or BACnet interface. Typically such a DALI master is a DALI push-button coupler or a similar device for manual control of DALI lights. As these devices directly control the DALI groups, they allow local operation of the lights independent of the L-DALI.

## Constant Light Controller Bindings across Channels

DALI groups and DALI sensors can be linked to constant lights controller instances using internal bindings across DALI channels (see Sections 6.3.1 and LINX Configurator User Manual [2]).

## Support for DALI ballasts with Colour Control

In the LDALI-10X models DALI ballasts of type “colour control” (device type 8) can be controlled. The LDALI-10X supports devices with changeable colour temperature and with coloured light. The latter can be used for effect lighting, while the previous can be used to simulate the colour temperature of the sun during the course of a day (warmer white during morning and evening, cooler white at noon).

## Support for additional DALI Sensors

Support for the ThebenHTS PlanoSpot 360 DALI multi-sensor was added.

## Change the DALI Short Address

If required the DALI short address, which was assigned to a DALI device by the L-DALI, can be changed via the Web-UI (see Section LOYTEC Device User Manual [1]).

## Generic Scheduler

Generic schedulers – like generic trends and alarms – can now be created, that are neither CEA-709 nor BACnet objects. Generic schedulers appear next to the generic alarm folder and are ready-to-use on any device. This is beneficial for creating technology-independent applications. Generic schedulers can write to any technology as well as data point favorites and are the ideal solution, if configured via LWEB-900 only. For more information on creating generic schedulers refer to the LOYTEC Device User Manual [1].

## Web Interface

The Web interface of the device offers a number of new features:

- Live update of values in the data point list. This allows monitoring values without repeated pressing of reload. Data point structures can be expanded or collapsed for better overview.
- Breadcrumb navigation has been added to the data point list. This gives faster access to sub-folders.
- A new firmware upgrade menu on the Web interface allows online checking for firmware updates and upgrading by selecting a local firmware file. All this is possible without starting the Configurator.
- The trend overview page displays current trend log states and provides controls for easy trend data upload in CSV format.
- The DALI group page allows switching groups on and off to test the group assignment.

## Application Objects

Application objects such as math objects, e-mail templates, and alarm logs can now be organized in folders. Copy and paste of application objects between Configurators has been improved. Math objects now allow single constants and single variable assignments, such as “=5” or “=v1”. Input variables can be configured to trigger a new calculation or not.

## 3 Quick-Start Guide

This Chapter contains step-by-step instructions on how to configure the L-DALI for the simple project shown in Figure 7.

The project consists of a single room (Room 306) which is illuminated by four DALI lamps. Two of those lamps form a light band near the windows of the room and the other two lamps form a light band near the corridor. The room is equipped with a DALI multi-sensor which acts as both a light sensor and an occupancy sensor. The build-in constant light controller of the L-DALI device uses the input from the DALI multi-sensor and dims the DALI ballasts accordingly. For manual override a DALI push-button is installed. The sunblind controller is not used in this quick-start example.

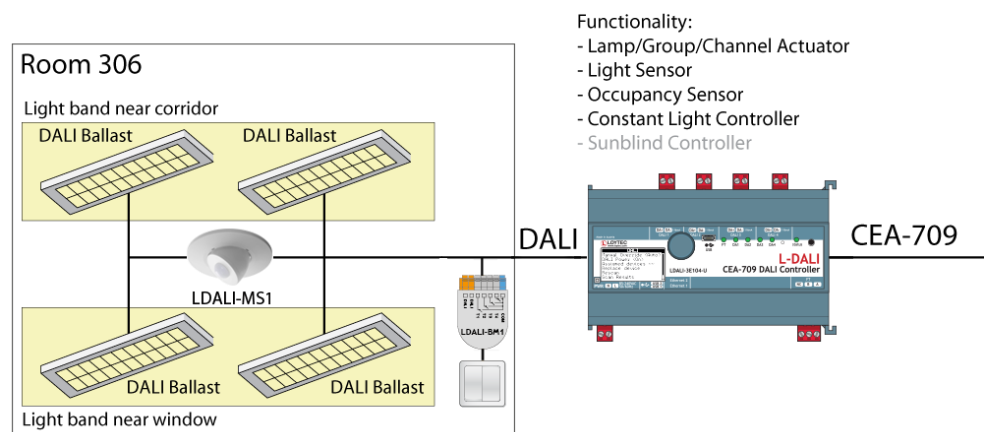

Figure 7: Quick-Start Example Project.

### 3.1 Hardware Installation

#### 3.1.1 Models without built-in DALI Bus Power Supply

For models without built-in DALI bus power supply it is recommended to use the LDALI-PWR4-U or LDALI-PWR2-U power supply together with the L-DALI. Connect the L-DALI to the LDALI-PWR4-U and to the DALI network as shown in Figure 8. To allow for easy configuration it is recommended to always connect the L-DALI to the Ethernet network. More detailed instructions are given in Chapter 4.

**Important:** *Do not connect terminal 26 to earth ground!*

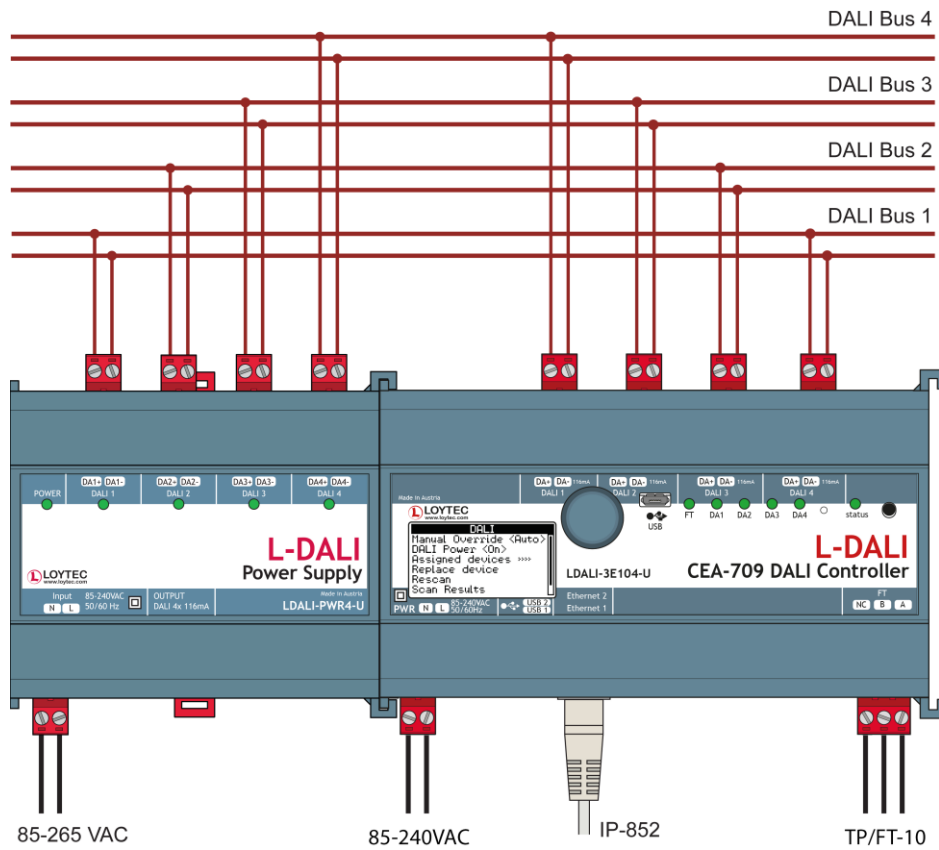

Figure 8: Basic Hardware Installation with external DALI bus power.

### 3.1.2 Models with built-in DALI Bus Power Supply

Connect the L-DALI to the power and to the DALI network as shown in Figure 9. To allow for easy configuration it is recommended to always connect the L-DALI to the Ethernet network (if available). More detailed instructions are given in Chapter 4.

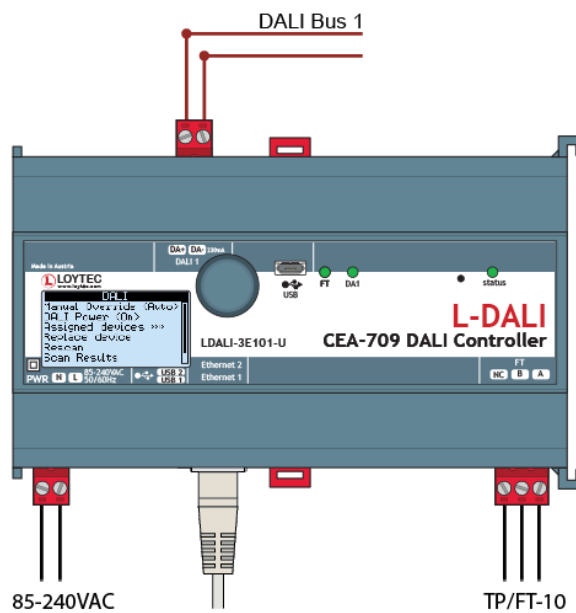

Figure 9: Basic Hardware Installation with integrated DALI bus power.



## 3.2 Test proper wiring of DALI devices

After the DALI ballasts have been installed and connected to the DALI network, the installation can be tested by following these steps:

### 3.2.1 Models without LCD display

1. Check that the DALI LEDs (“DALI x ACT”, where x is 1 to 4) do not light up red. If one of these LEDs is red, check the proper connection of the bus power supply for the corresponding channel and check the DALI wiring for short-circuits.
2. Press the DALI mode button (“ON/OFF/AUTO”) on the front panel of the L-DALI once. Now all DALI ballasts should be switched on (maximum level) and the DALI LEDs on the L-DALI should light up green.
3. Press the DALI mode button again. Now all DALI ballasts should be switched off and the DALI LEDs on the L-DALI should light up orange.
4. Press the DALI mode button again. This should not change the state of the DALI ballasts but return the L-DALI to the auto-mode (control via CEA-709/BACnet interface).

### 3.2.2 Models with LCD display

1. On LDALI models with only one DALI channel check that status LED does not light up red, on models with multiple DALI channels check the DALI LEDs (“DALI x ACT”, where x is 1 to 4). If the LED is red, check the DALI wiring for short-circuits. In case an external bus-power supply is used check the proper connection of the bus power supply for the corresponding channel.
2. Turn the jog dial to navigate to the DALI menu item.

```

LOYTEC LDALI-E101-U
  Unnamed Project
    192.168.3.51
# 28% 100FD
DALI >>>>
Datapoints >>>>
Device Settings >>>>
  
```

3. Press down to jog dial to enter the DALI menu.

```

DALI
Channel: 1
Manual Override <Auto>
DALI Power <On>
Assigned devices >>>>
Replace device >>>>
Rescan >>>>
  
```

4. On devices with multiple DALI channels select menu item “Channel” and select the DALI channel to be tested.

```

DALI
Channel: 1
Manual Override <Auto>
DALI Power <On>
Assigned devices >>>>
Replace device >>>>
Rescan >>>>
  
```

5. Turn the jog dial to navigate to the menu item “Manual Override: Auto”.

```

DALI
Channel: 1
Manual Override <Auto>
DALI Power <On>
Assigned devices >>>>
Replace device >>>>
Rescan >>>>
  
```

- Press down the jog dial. Then turn it one step to the right. The manual override must change to “On”.

```

DALI
Channel: 1
Manual Override <On>
DALI Power <On>
Assigned devices >>>
Replace device >>>
Rescan >>>

```



Now all DALI ballasts should be switched on and the status LED on the L-DALI should light up green.

- Turning the dial one more step right the manual override must change to “Off”.

```

DALI
Channel: 1
Manual Override <Off>
DALI Power <On>
Assigned devices >>>
Replace device >>>
Rescan >>>

```



Now all DALI ballasts should be switched off and the status LED on the L-DALI should light up orange.

- Turn the dial one step right once more. This should not change the state of the DALI ballasts but return the manual override back to the auto-mode (control via L-DALI light application).

```

DALI
Channel: 1
Manual Override <Auto>
DALI Power <On>
Assigned devices >>>
Replace device >>>
Rescan >>>

```



---

## 3.3 Device configuration

The L-DALI can be configured via a console interface or via the Web interface. To configure the L-DALI, the following steps have to be performed:

- Setup IP configuration (see Sections 3.3).
- Setup the DALI network (see Section 3.5 or 3.6).

---

*Note:* This setup procedure assumes the use of the IP interface.

---

## 3.4 Configuration of IP Address

### 3.4.1 IP Configuration via the LCD Display

Device models with an LCD display can also be configured to their basic settings through jog dial navigation on the LCD UI. Turn the jog dial to navigate between menu items and press to enter a menu or go into selection mode. When in selection mode turn the jog dial to alter the value and press again to quit the selection. Some input fields provide acceleration. This means turning faster changes the value in larger increments.

#### To Set the IP Address on the LCD Display

- On the LCD main screen set the desired language. Navigate to the flag symbol, press the button and choose the desired language.

```

LOYTEC LDALI-E101-U
  Unnamed Project
  192.168.3.51
# 22% # ✓
DALI >>> 100FD
Datapoints >>>
Device Settings >>>

```

2. Navigate to the IP address on the main screen and press the button.

```

LOYTEC LDALI-E101-U
  Unnamed Project
  192.168.3.51
# 26% # ✓
DALI >>> 100FD
Datapoints >>>
Device Settings >>>

```

3. There navigate to the needed input fields, press and change the value. Press again to set the value. Continue to the next field.

```

TCP/IP Setup
DHCP: OFF
Addr: 192.168.003.051
Mask: 255.255.192.000
Gtwy 192.168.001.001
Save and reboot

```

4. Finally navigate to **Save and reboot** and press.
5. Acknowledge the reboot and the device reboots with the new IP address.

### 3.4.2 IP Configuration via the Web Interface

As an alternative to the console interface the Web interface can be used to configure the device. In a Web browser enter the default IP address 192.168.1.254 of the L-DALI. Note that if your PC has an IP address in a subnet other than 192.168.1.xxx please open a command tool and enter the following route command to add a route to the L-DALI.

#### To Add a Route to the Device

1. Windows **START** → **Run**
2. Enter 'cmd' and click **OK**.
3. In the command window enter the command line

```
route add 192.168.1.254 %COMPUTERNAME%
```

In Windows7 replace %COMPUTERNAME% with the PC's actual IP address.
4. Then open your Web browser and type in the default IP address 192.168.1.254.

**LOYTEC** Device Info

LDALI-3E104  
2015-05-27 10:07:25

networks under control

**General Info**

Product	LDALI-3E104, firmware 5.2.0	2015-05-22 16:19:45
Hostname	ldali-og3, 10.101.18.160	
Serial number	013301-8000000B7618	
Free RAM, heap, flash	3897 KB, 257 KB, 1997 KB	
CPU, temp, supply	70%, 42°C, 23V	
NTP status	in-sync	
Uptime	4 days, 14:17:53	

**Device Status**

**Warning**

✓ DALI Channel 1	27 devices online
✓ DALI Channel 2	25 devices online
✓ DALI Channel 3	26 devices online
! DALI Channel 4	Bus supply failed

CEA-709 ✓CEA-709

Ethernet 10.101.18.160

- ✓connected
- ✓FTP ✓Telnet ✓Web UI ✓HTTP
- ✓Global Connections (CEA-852)
- ✓OPC XML-DA (3 clients, 2 subscriptions)

**Firmware Info**

	Primary (ACTIVE)	Fallback
Firmware	L-DALI Primary Image	L-DALI Fallback Image
Version	5.2.0	0.99.0
Build date	2015-05-22 16:19:45	2009-07-30 12:30:24

**Project Information**

Project file	20111108_LDali.Ldali	<input type="checkbox"/> Remote config
Project name	L-DALI default	
Project timestamp (UTC)	2015-02-26 13:07:19	
Project status	ok	

**CEA-709 application unique node IDs and program IDs**

Node	NID	PID	Status	Action
CEA-709 Node 1	80 00 00 0B 76 18	90 00 D7 22 00 8A 04 02	Online	Send Service Pin
IP Node 1	inactive			
CEA-709 Node 2	80 00 00 0B 76 19	90 00 D7 22 00 8A 04 02	Online	Send Service Pin
IP Node 2	inactive			
CEA-709 Node 3	80 00 00 0B 76 1A	90 00 D7 22 00 8A 04 02	Online	Send Service Pin
IP Node 3	inactive			
CEA-709 Node 4	80 00 00 0B 76 1B	90 00 D7 22 00 8A 04 02	Offline	Send Service Pin
IP Node 4	inactive			

Figure 10: Example Start Screen.

- Click on **Config** in the left menu. You will be asked to enter the administrator password in order to change the IP settings. Enter 'loytec4u' and select **Login**.

**LOYTEC** Login

LDALI-3E104  
2015-05-27 10:08:47

under control

Enter your username and password

Account:

Password:

Figure 11: Enter 'loytec4u' as the default administrator password.

- The Config menu opens. Click on **Port Config** in the Config menu and select **Ethernet 1 (LAN)** tab. Enter the IP address, the IP netmask, and IP gateway for this device as shown in Figure 12.
- Press **Save Settings** and then reset the device by selecting **Reset** in the highlighted text. This changes the IP settings of the device.

Figure 12: Enter IP address and gateway.

### 3.4.3 IP Configuration via Console

If your model is equipped with a console interface use a standard null-modem cable with full handshaking to connect COM1 of the PC to the Console on the device. Use a PC terminal program with the communication settings set to 38,400 bps / 8 data bits / no parity / 1 stop bit / no handshake. Power up the device or press **Return** if the device is already running. The following menu should appear on the terminal:

Device Main Menu

```

[1] Show device information
[2] Serial firmware upgrade
[3] System configuration
[4] DALI maintenance
[5] IP configuration
[6] CEA-852 device configuration
[7] CEA-709 configuration
[8] Reset configuration (factory defaults)
[9] Device statistics

[a] Data Points

[0] Reset device

Please choose:

```

Figure 13: Device Main Menu.

Select '5' from the device main menu and enter the IP address, netmask, and gateway address. Note that you must use different IP addresses if you are using multiple IP devices in your setup.

## IP Configuration Menu

```

[1] DHCP          : disabled
[2] IP Address    : 192.168.1.254
[3] IP Netmask    : 255.255.255.0
[4] IP Gateway    : 192.168.1.1
[5] Hostname      : new
[6] Domainname   : <unset>
[7] DNS Servers  : <unset>
[9] MAC Address   : 00:0A:B0:01:0C:9F (factory default)
[0] NTP Servers   : <unset> (out-of-sync)
[b] Link Speed & Duplex : Auto Detect

[q] Quit without saving
[x] Exit and save

```

Please choose:

Figure 14: Enter basic IP settings.

Press 'x' to save the IP settings and reset the device with the main menu item '0' in order to let the new IP settings take effect.

**Important!**

*The default IP address 192.168.1.254 is only set for configuration access. It must be changed in order to make the device functional.*

### 3.5 Configuration with PC Software

For the LDALI product family a PC based configuration software – the LINX Configurator – is available. As an alternative the web interface can be used for configuration (see Section 3.6).

Install the LINX Configurator software from the setup.exe. This file can be downloaded from [www.loytec.com](http://www.loytec.com). This tool can be used as a stand-alone tool or as LNS plug-in. In this example we will use the LINX Configurator software as a stand-alone tool.

A detailed description of the LINX Configurator configuration software can be found in the LINX Configurator User Manual [2].

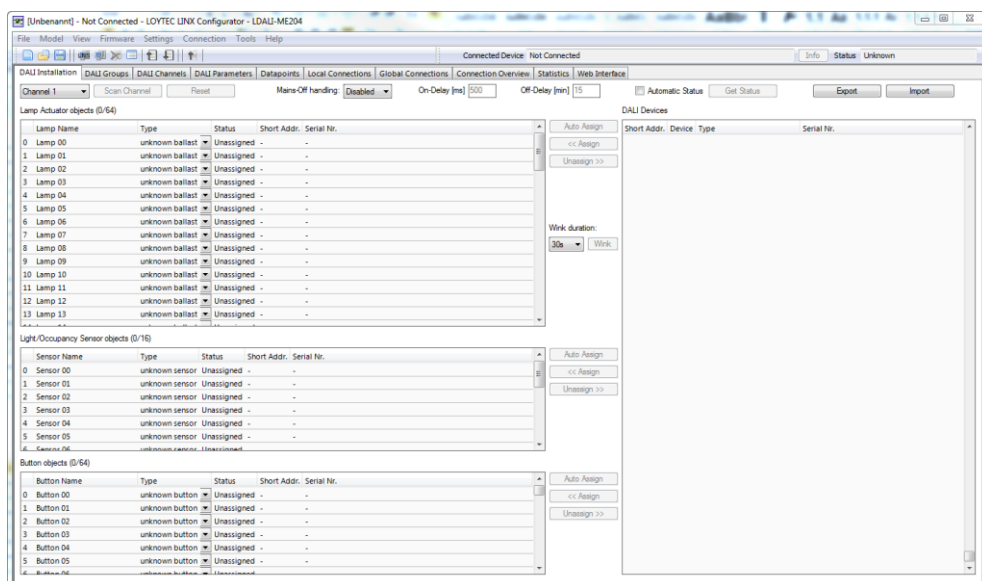

Figure 15: LINX Configurator software, Start.

### 3.5.1 Connect to Device in Stand-Alone Mode

1. Select the IP connection method by clicking on the **Connect to device** button in the tool bar as shown in Figure 16.

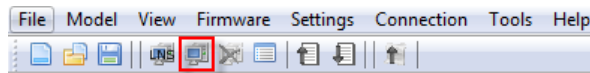

Figure 16: LINX Configurator software, Connect to device

2. In the Connection dialog (see Figure 17) choose connection type “Web Service”, enter the IP address or hostname of the L-DALI and the device’s “admin” password. The default “admin” password is ‘loytec4u’ (older firmware versions used ‘admin’).
3. Optionally, click on **New** and enter a user-defined name for this connection. That name can be selected later to connect. Click on **Save** to store that connection.
4. Click on **Connect**. This establishes the connection to the device.
5. The LINX Configurator software asks if you want to upload the current configuration of the device. You can cancel this dialog because in this quick-start we configure the device from scratch.

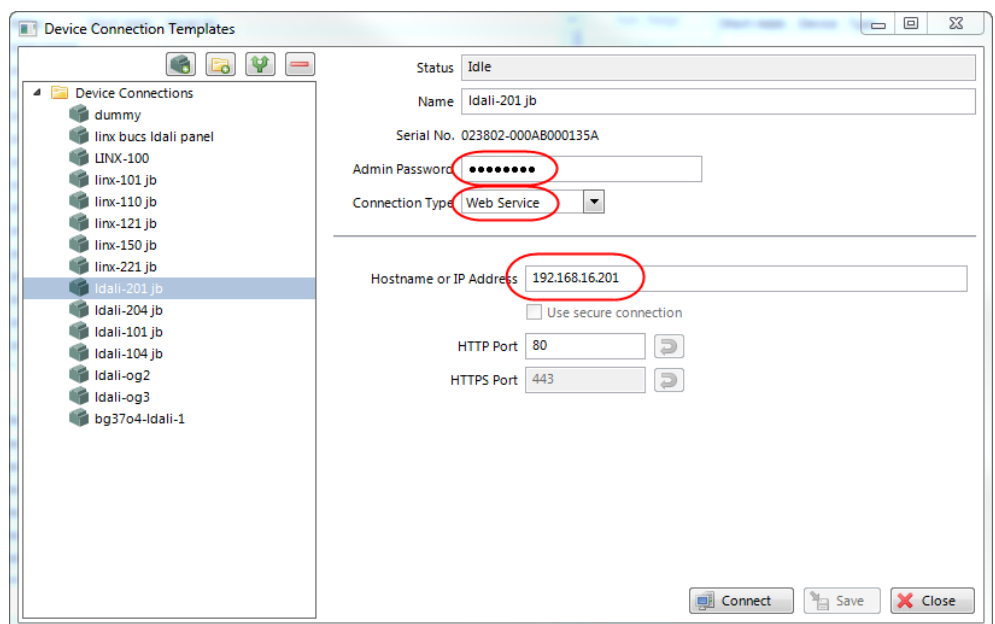

Figure 17: LINX Configurator software, Connection Dialog.

### 3.5.2 Scan DALI Channel

1. Change to the **DALI Installation** tab.
2. Select the DALI channel and click on the **Scan Channel** button shown in Figure 18.

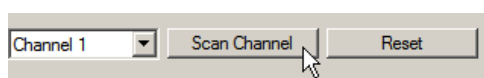

Figure 18: LINX Configurator software, scan DALI Channel.

- The L-DALI device scans the selected channel and displays all detected devices as shown in Figure 19. In case an error occurs see the LOYTEC Device User Manual [1] for a description of the error codes and possible reasons.

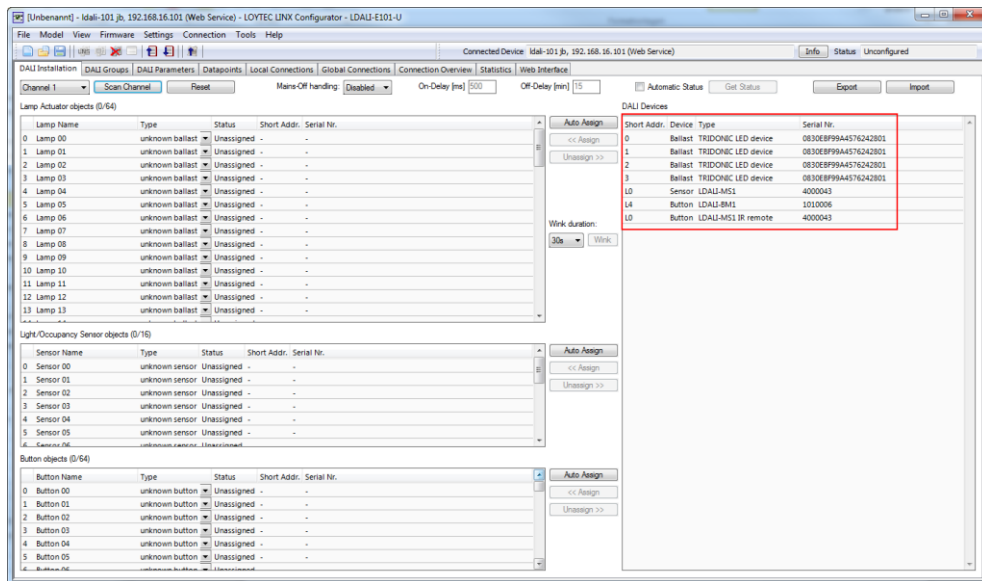

Figure 19: LINX Configurator software, detected DALI devices.

### 3.5.3 Assign Lamps, Sensor and Button to LONMARK/BACnet Objects

- To identify which of the four detected DALI ballasts is which physical lamp, select one and click the **Wink** button. The corresponding lamp blinks for the configured wink duration.

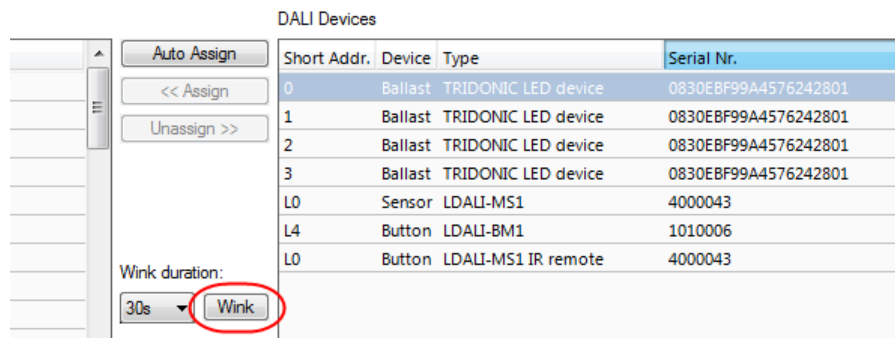

Figure 20: LINX Configurator software, Wink button.



Lamp Actuator objects (4/64)

	Lamp Name	Type	Status	Short Addr.	Serial Nr.
0	lamp_306_window_0	TRIDONIC low voltage halogen lamp	Unknown (modified)	0	-
1	lamp_306_windo_1	TRIDONIC low voltage halogen lamp	Unknown (modified)	1	-
2	lamp_306_corridor_0	TRIDONIC low voltage halogen lamp	Unknown (modified)	2	-
3	lamp_306_corridor_1	TRIDONIC low voltage halogen lamp	Unknown (modified)	5	-
4	Lamp 04	unknown ballast	Unassigned	-	-
5	Lamp 05	unknown ballast	Unassigned	-	-
6	Lamp 06	unknown ballast	Unassigned	-	-
7	Lamp 07	unknown ballast	Unassigned	-	-
8	Lamp 08	unknown ballast	Unassigned	-	-

Figure 21: LINX Configurator software, assigned Lamp Actuator objects.

- To assign a DALI ballast to an object, select the ballast in the list of **DALI Devices** and drag it to the desired position in the **Lamp Actuator objects** list on the left side. You can change the names of the lamp actuator objects. After you have assigned all lamps and changed the names the configuration should look as shown in Figure 21.
- To assign the DALI multi-sensor to an object, select the sensor in the list of **DALI Devices** and drag it to the desired position in the **Light/Occupancy Sensor objects** list on the lower left side. After you have changed the names of the sensor object the configuration should look as shown in Figure 22.

Light/Occupancy Sensor objects (1/16)

	Sensor Name	Type	Status	Short Addr.	Serial Nr.
0	sensor_room_306	LDALI-MS1	Unknown (modified)	L0	4000043
1	Sensor 01	unknown sensor	Unassigned	-	-
2	Sensor 02	unknown sensor	Unassigned	-	-
3	Sensor 03	unknown sensor	Unassigned	-	-
4	Sensor 04	unknown sensor	Unassigned	-	-
5	Sensor 05	unknown sensor	Unassigned	-	-

Figure 22: LINX Configurator software, Assigned Light/Occupancy Sensor Object.

- Similar, assign the DALI button by dragging it to the desired position in the **Button objects** list.

### 3.5.4 Grouping Lamps

Lamps which are assigned to a group can be controlled together by the corresponding group object. We will create three groups: One for the lamps near the window, one for the lamps near the corridor and one for all lamps in the room.

- In the LINX Configurator software switch to the **DALI Groups** tab.
- Add the two lamps near the window to group 0, the two lamps near the corridor to group 1 and add all lamps in the room to group 2. Assign names to the groups as shown in Figure 23.

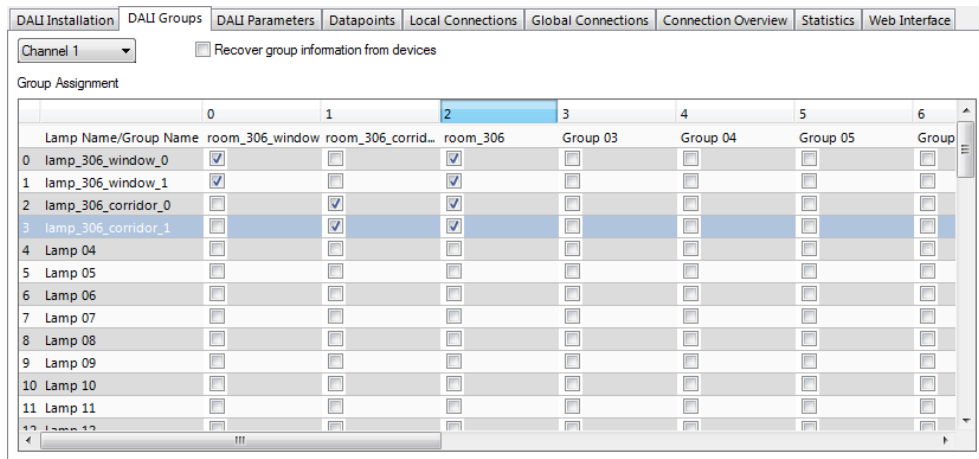

Figure 23: LINX Configurator software, DALI group configuration.

### 3.5.5 Parameterize the Constant Light Controller

1. In the LINX Configurator software switch to the **DALI Parameters** tab.
2. Select the constant light controller with index 0 as shown in Figure 24. The parameters of the selected constant light controller are displayed in the middle of the window (1).

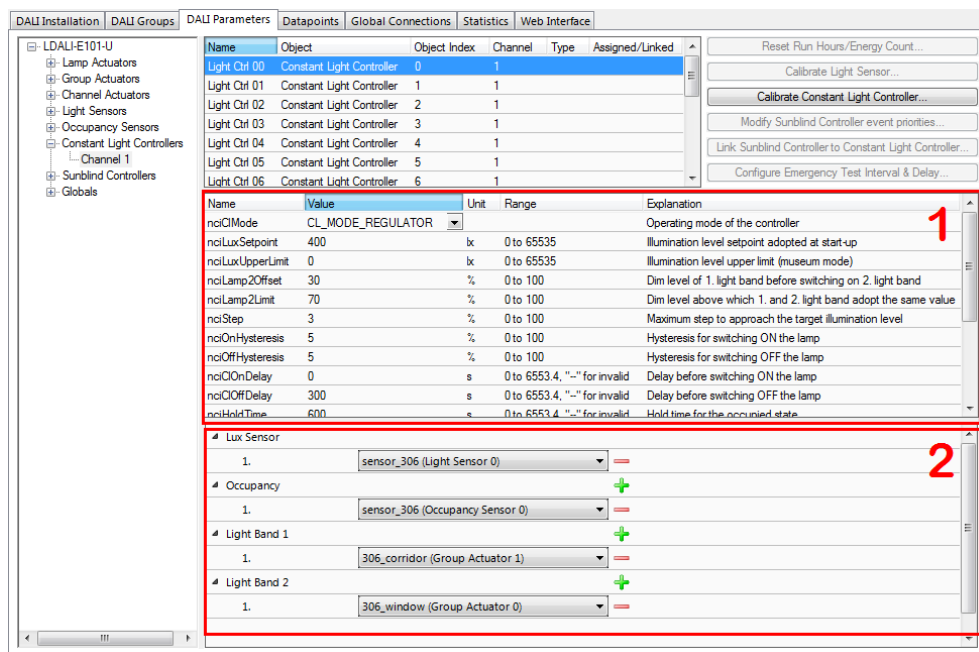



Figure 24: Parameterize Constant Light Controller.

3. Change the parameter *nciCMode* to *CL\_MODE\_REGULATOR*. This parameter selects the operating mode. The *REGULATOR* mode is used if a light/occupancy sensor is installed which measures the indoor illumination.
4. Change the setpoint of the constant light controller (*nciLuxSetpoint*) to the desired light level (e.g. 400 lux).
5. You can leave the default values for the remaining parameters. For a description of the constant light controller functionality and the parameters refer to Section 6.1.4.

- Determine which sensors (occupancy & lux) are used as inputs to the constant light controller instance and which groups are controlled in the lower part of the window (2).
- Click on the  to add an input or output. Use the drop down box to select a sensor (input) or a light group (output). In our example we use “sensor\_306” for lux and occupancy sensor inputs, group “306\_corridor” as output of the first (brighter) light band and group “306\_window” as output for the second (darker) light band.

### 3.5.6 Parameterize the DALI button

- Stay on the **DALI Parameters** tab and select the button object to which you have assigned your DALI button as shown in Figure 25.

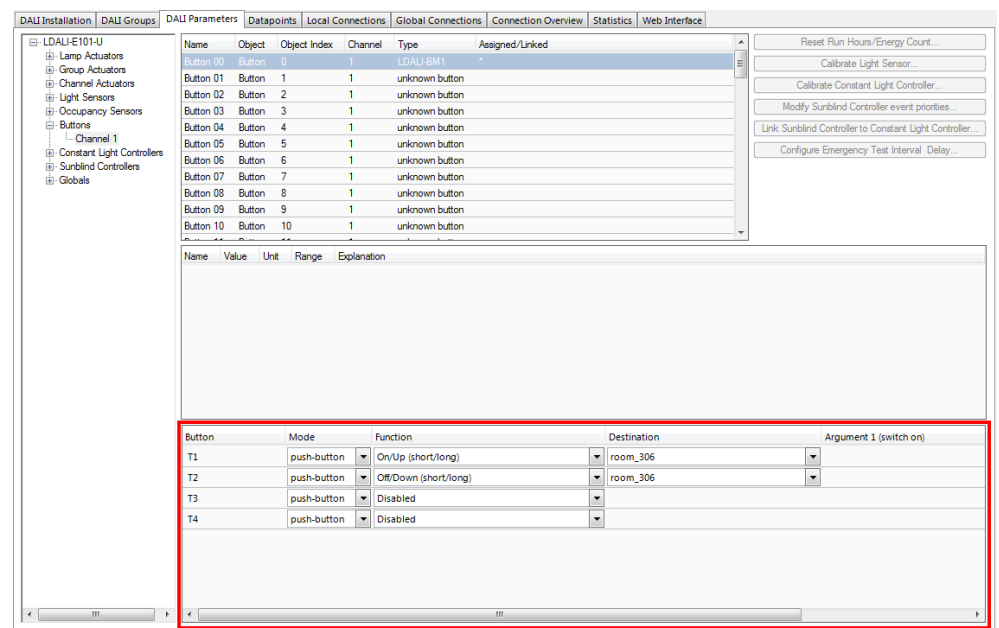

Figure 25: Parameterize DALI button functions.

- Determine which function is executed and which group is controlled by which button input in the lower part of the window. In our example we use button T1 for “On/Up” and T2 for “Off/Down”, both controlling group “room\_306”. This will allow us to control all lights in the room together.

### 3.5.7 Download Configuration

- To download the configuration into the L-DALI device click on the **Download Configuration** button in the toolbar.



Figure 26: LINX Configurator software, Download Configuration.

- Because we have changed only the DALI configuration and the parameters it is sufficient to check only DALI Configuration and Parameters in the following dialog. This speeds up the download process.

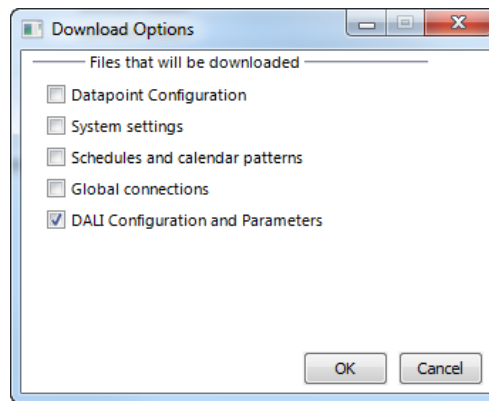

Figure 27: LINX Configurator software, Download DALI Configuration and Parameters.

- After the download is complete, go back to the DALI Installation tab and press the **Get Status** button. Now the assigned DALI devices are displayed on a green background (see Figure 28). The green background color indicates that the communication with the device is OK. If there is a communication error, the device will be displayed with a red background color.

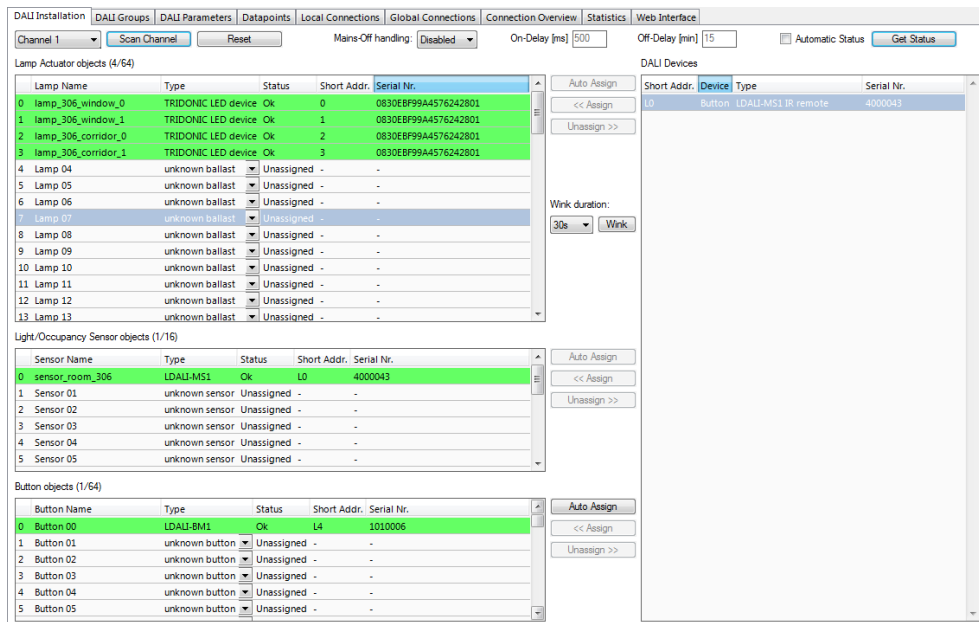

Figure 28: LINX Configurator software, After Configuration Download.

### 3.5.8 Calibrate Light Sensor

The L-DALI device allows calibrating the light sensor under up to seven different light conditions to counter any non-linearity of the sensor. However, in many cases it is enough to calibrate the sensor with a single light condition which is near the setpoint. In this quick-start only one lux measurement is performed.

- In the LINX Configurator software switch to the **Parameters** tab.
- Select the light sensor index 0 and click on the **Calibrate Light Sensor...** button as shown in Figure 29. The light sensor calibration window as shown in Figure 30 is displayed.

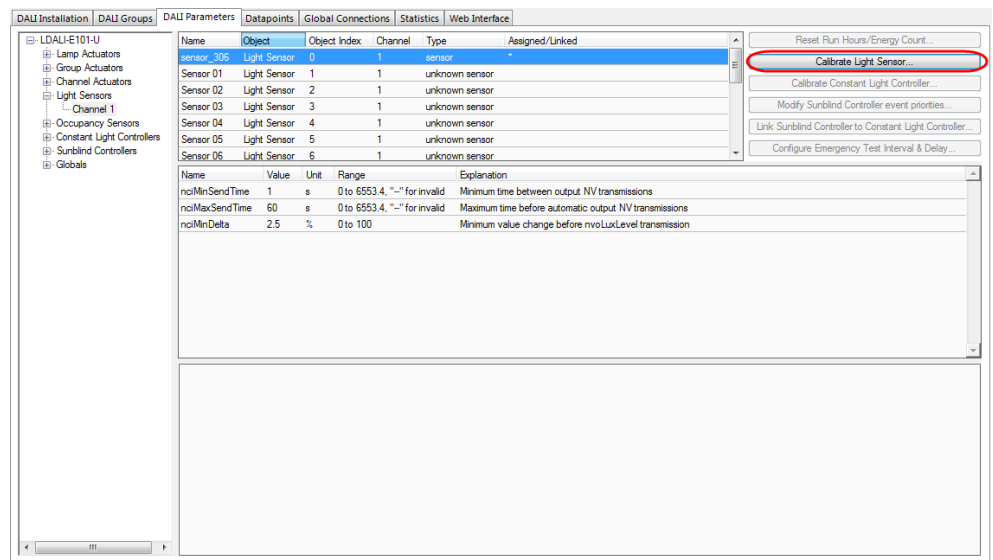

Figure 29: Parameterize Light Sensor.

3. Measure the current lux level at the reference area (e.g. desk) using a luxmeter.
4. Enter the measured lux level in the input field and select the index 0.
5. Press the **Calibrate** button.
6. Close the dialog by pressing the **Done** button.

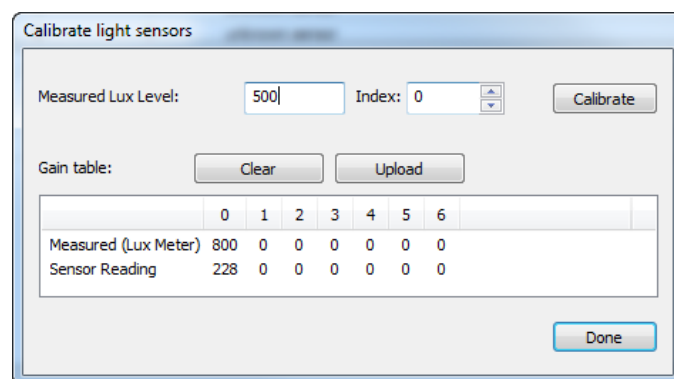

Figure 30: Calibrate Light Sensor.

## 3.6 Configuration using Web Interface

As an alternative to the LINX Configurator PC Software the Web interface of the L-DALI can be used. In a Web browser enter the IP address as set up in Section 3.4.

A detailed description of the L-DALI Web interface can be found in the LOYTEC Device User Manual [1].

### 3.6.1 Scan DALI Channel

1. In the L-DALI Web interface click on **Commission** in the left menu. If not already logged in you will be asked to enter the administrator password. Enter 'loytec4u' and select **Login**.

- The Commission menu opens. Click on **DALI Installation** in the Commission menu. The DALI installation page opens as shown in Figure 31.

Channel 1 Channel 2 Channel 3 Channel 4

Wink Duration: 30 sec Mains-Off handling: Disabled Mains-On delay: 500 ms Mains-Off delay: 0 min DALI Power: Off Save

Devices in Database

Reload Reset Action on Selected Execute

Name	Type	Nom. Pwr	Status	Short Addr.	Serial Number
no devices found					

Scanned Devices not in Database

Scan Clear Results Save Assignment Auto Assign

Name	Short Addr.	Type	Serial Nr.
no devices found			

Unassigned Devices

Search

Name	Type	Serial Nr.
no devices found		

Figure 31: DALI Installation Web Interface: Initial view.

- If the device supports more than one DALI channel select the DALI channel by clicking on the different tabs at the top of the page labeled **Channel 1**, **Channel 2**, etc. and press the **Scan** button.

Wink Duration: 30 sec Mains-Off handling: Disabled Mains-On delay: 500 ms Mains-Off delay: 15 min DALI Power: On Save

Devices in Database

Reload Reset Action on Selected Execute

Name	Type	Nom. Pwr	Status	Short Addr.	Serial Number
no devices found					

Scanned Devices not in Database

Scan Clear Results Save Assignment Auto Assign

Name	Short Addr.	Type	Serial Nr.
<b>Lamps</b>			
UNASSIGNED	00	LED device	0830EBF99A4576242801
UNASSIGNED	01	LED device	0830EBF99A4576242801
UNASSIGNED	02	LED device	0830EBF99A4576242801
UNASSIGNED	03	LED device	0830EBF99A4576242801
<b>Sensors</b>			
UNASSIGNED	L00	LDALI-MS1	4000043
<b>Buttons</b>			
UNASSIGNED	L00	LDALI-BM1	1010006
UNASSIGNED	L00	LDALI-MS1 IRT	4000043

Unassigned Devices

Search

Name	Type	Serial Nr.
no devices found		

Figure 32: DALI Installation Web Interface: Detected DALI devices.

- The L-DALI scans the DALI channel and lists the detected devices under **Scanned Devices not in Database** in the lower half of the Web interface (see Figure 32). In case an error occurs see the LOYTEC Device User Manual [1] for a description of the error codes and possible reasons.

### 3.6.2 Assign Lamps, Sensor and Button to LONMARK/BACnet Objects

1. To identify which of the four detected DALI ballasts is which physical lamp, select one and click the **Wink** button. The corresponding lamp blinks for the configured wink duration.
2. To assign a DALI device to a LONMARK or BACnet object, use the drop-down list available for each device in the **Scanned Devices not in Database** section (left column). This list contains all available fieldbus objects. When you are done, press the button **Save Assignment**. Alternatively to manual assignment press the button **Auto Assign** for random assignment. After you have assigned all lamps the configuration should look as shown in Figure 33.

Wink Duration: 30 sec | Mains-Off handling: Disabled | Mains-On delay: 500 ms | Mains-Off delay: 15 min | DALI Power: On | Save

---

**Devices in Database**

Reload | Reset | Action on Selected: [v] | Execute

Name	Type	Nom. Pwr	Status	Short Addr.	Serial Number	
<b>Lamps</b>						
0 Lamp 1_00	LED device	0 W	OK: 0%	00	0830E8F99A4576242801	Wink On Off
1 Lamp 1_01	LED device	0 W	OK: 0%	01	0830E8F99A4576242801	Wink On Off
2 Lamp 1_02	LED device	0 W	OK: 0%	02	0830E8F99A4576242801	Wink On Off
3 Lamp 1_03	LED device	0 W	OK: 100%	03	0830E8F99A4576242801	Wink On Off
<b>Sensors</b>						
0 Sensor 1_00	LDALI-MS1	-	OK: 64 lux unoccupied	L00	4000043	Wink Calibrate
<b>Buttons</b>						
0 Button 1_00	LDALI-BM1	-	OK: -	L00	1010006	Configure

---

**Scanned Devices not in Database**

Scan | Clear Results | Save Assignment | Auto Assign

Name	Short Addr.	Type	Serial Nr.
rescan necessary			

---

**Unassigned Devices**

Search

Name	Type	Serial Nr.
no devices found		

Figure 33: DALI Installation Web Interface: Device assignment done.

### 3.6.3 Grouping Lamps

Lamps which are assigned to a group can be controlled together by the corresponding LONMARK or BACnet group object. We will create two groups: One for the lamps near the window and one for the lamps near the corridor.

1. Click on **DALI Groups** in the Config menu. The DALI Groups page opens.
2. Again, selected the DALI channel by clicking on the different tabs at the top of the page labeled **Channel 1**, **Channel 2**, etc.
3. Add the two lamps near the window to group 0, the two lamps near the corridor to group 1 and all lamps to group 2 by checking the corresponding check boxes. Press the **Save** button. The result will look like in Figure 34.

LOYTEC DALI Groups

LDALI-ME204  
Logged in as  
admin  
2015-05-27 11:09:23

networks under control

Channel 1 Channel 2 Channel 3 Channel 4

Save Reload

#	0	1	2	3	4	5	6	7	8	9	10	11	12	13	14	15
Group	Group 00	Group 01	Group 02	Group 03	Group 04	Group 05	Group 06	Group 07	Group 08	Group 09	Group 10	Group 11	Group 12	Group 13	Group 14	Group 15
On/Off	<input type="checkbox"/>	<input type="checkbox"/>	<input type="checkbox"/>	<input type="checkbox"/>	<input type="checkbox"/>	<input type="checkbox"/>	<input type="checkbox"/>	<input type="checkbox"/>	<input type="checkbox"/>	<input type="checkbox"/>	<input type="checkbox"/>	<input type="checkbox"/>	<input type="checkbox"/>	<input type="checkbox"/>	<input type="checkbox"/>	<input type="checkbox"/>
Override	-	0	-	-	-	-	-	-	-	-	-	-	-	-	-	-
Feedback	0	0	0	0	0	0	0	0	0	0	0	0	0	0	0	0
Lamp 00	<input checked="" type="checkbox"/>	<input type="checkbox"/>	<input checked="" type="checkbox"/>	<input type="checkbox"/>	<input type="checkbox"/>	<input type="checkbox"/>	<input type="checkbox"/>	<input type="checkbox"/>	<input type="checkbox"/>	<input type="checkbox"/>	<input type="checkbox"/>	<input type="checkbox"/>	<input type="checkbox"/>	<input type="checkbox"/>	<input type="checkbox"/>	<input type="checkbox"/>
Lamp 01	<input checked="" type="checkbox"/>	<input type="checkbox"/>	<input checked="" type="checkbox"/>	<input type="checkbox"/>	<input type="checkbox"/>	<input type="checkbox"/>	<input type="checkbox"/>	<input type="checkbox"/>	<input type="checkbox"/>	<input type="checkbox"/>	<input type="checkbox"/>	<input type="checkbox"/>	<input type="checkbox"/>	<input type="checkbox"/>	<input type="checkbox"/>	<input type="checkbox"/>
Lamp 02	<input type="checkbox"/>	<input checked="" type="checkbox"/>	<input checked="" type="checkbox"/>	<input type="checkbox"/>	<input type="checkbox"/>	<input type="checkbox"/>	<input type="checkbox"/>	<input type="checkbox"/>	<input type="checkbox"/>	<input type="checkbox"/>	<input type="checkbox"/>	<input type="checkbox"/>	<input type="checkbox"/>	<input type="checkbox"/>	<input type="checkbox"/>	<input type="checkbox"/>
Lamp 03	<input type="checkbox"/>	<input checked="" type="checkbox"/>	<input checked="" type="checkbox"/>	<input type="checkbox"/>	<input type="checkbox"/>	<input type="checkbox"/>	<input type="checkbox"/>	<input type="checkbox"/>	<input type="checkbox"/>	<input type="checkbox"/>	<input type="checkbox"/>	<input type="checkbox"/>	<input type="checkbox"/>	<input type="checkbox"/>	<input type="checkbox"/>	<input type="checkbox"/>

Save Reload

Figure 34: DALI Installation Web Interface: Group Configuration.

- To test the group assignment, lights can be switched on and off by clicking on the bulb below the group name. Similar entering a value in the override row will dim the corresponding group. Entering – in the field will relinquish an active override.

### 3.6.4 Calibrate Light Sensor

The L-DALI device allows calibrating the light sensor under up to seven different light conditions to counter any non-linearity of the sensor. However, in many cases it is enough to calibrate the sensor with a single light condition which is near the setpoint. In this quick-start only one lux measurement is performed.

- Go to the DALI Installation page and press the **Calibrate** button next to the sensor that is to be calibrated. The DALI sensor calibration page is shown in Figure 35.

← back Sensor: 'Sensor\_1\_00' Level: 108 lux

Measure the current lux value and select the index in the gain table to store the measurement.

Dim lights: Group\_1\_00 Level: 100% Set Auto

Measured lux level: Index: 0 Calibrate

Clear gain table Import Export

Gain table	0	1	2	3	4	5	6
Measured (lux meter)	100	0	0	0	0	0	0
Sensor reading	1196	0	0	0	0	0	0

Copy to selected  
→ No sensors available

Figure 35: DALI Installation Web Interface: Sensor Calibration.

- Measure the current lux level at the reference area (e.g. desk) using a luxmeter.



3. If possible dim artificial light in room until luxmeter show desired lux setpoint. To dim the light select the rooms DALI group in the **Dim lights** drop down box, enter a desired dim value in the field **Level** and press the **Set** button.
4. Enter the measured lux level in the input field and select index 0.
5. Press the **Calibrate** button.

### 3.6.5 Parameterize the DALI button

1. On the DALI Installation page click on the **Configure** button next to the button device that is to be configured. The dialog shown in Figure 36 appears.

Button	Mode	Function	Destination	Arg. 1 (switch on)	Arg. 2 (switch off)
T1	push-button	On/Up (short/long)	Group 02		
T2	push-button	Off/Down (short/long)	Group 02		
T3	push-button	Disabled			
T4	push-button	Disabled			

Copy settings to:

Buttons: Cancel, Save, Copy

Figure 36: Configure DALI button functions.

2. Use the drop-down boxes to determine which function is executed and which group is controlled by which button input. In our example we use button T1 for “On/Up” and T2 for “Off/Down”, both controlling group 2. This will allow us to control all lights in the room together.
3. Click on **Save** to write the configuration to the button device.

### 3.6.6 Parameterize the Constant Light Controller

1. Go to the **Data Points** page and select the data point path of constant light controller application instance 0.

Folder: /BACnet Port/Datapoints/Channel 1/Constant Light Controllers/Constant Light Controller 0

Name	Dir.	Type	State	Value
Controller	output	analog	invalid value	--
Object Name	output	string	normal	Constant_Light_1_00
Reliability	output	analog	invalid value	--
Controlled_Variable_Value	input	analog	normal	508
Setpoint	input	analog	normal	500
Occupancy_Variable_Value	input	binary	normal	unoccupied
Mode	input	multistate	normal	REGULATOR
Hold_Time	input	analog	normal	0
Ignore_Time	input	analog	normal	0
Occupied_Level	input	analog	normal	0
Unoccupied_Level	input	analog	normal	0
Step_Value	input	analog	normal	0
On_Hysteresis	input	analog	normal	0
Off_Hysteresis	input	analog	normal	0
Off_Delay	input	analog	normal	0
On_Delay	input	analog	normal	0
Artificial_Light	input	user	invalid value	--
Gain	input	user	invalid value	--

Figure 37: DALI Installation Web Interface: Parameters.

BACnet L-DALI: /BACnet Port/Datapoints/Channel 1/Constant Light Controllers/Constant Light Controller 0/

CEA-709 L-DALI: /CEA709 DALI Channel 1/Datapoints/Constant Light Controllers/Constant Light Controller 0/

The page will look like in Figure 37.

- The parameters of the selected constant light controller are displayed on the right side. Change the constant light controller mode (parameter *nciCIMode* or *Mode*) to REGULATOR. This parameter selects the operating mode. The REGULATOR mode is used if a light/occupancy sensor is installed which measures the indoor illumination.

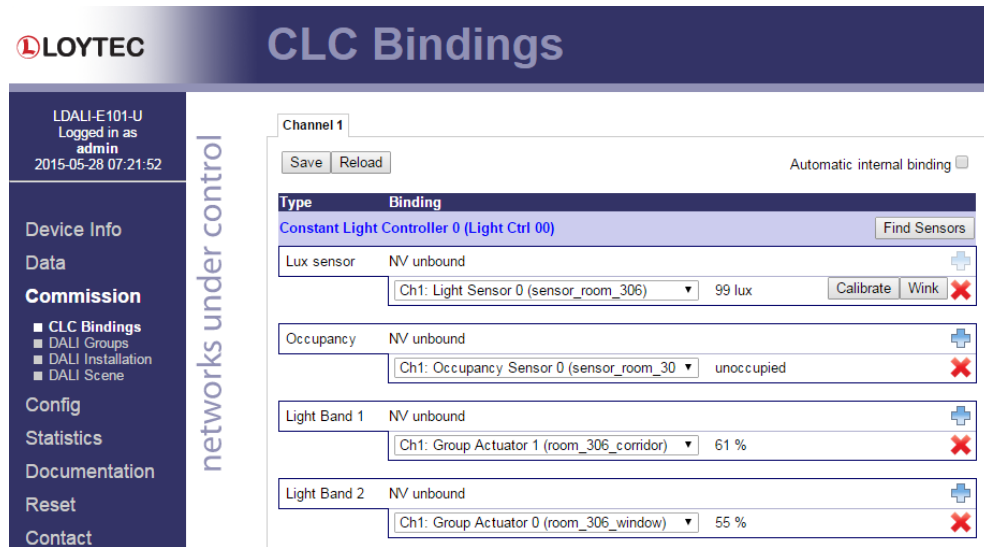

Figure 38: DALI Installation Web Interface: CLC Bindings.

- Change the setpoint of the constant light controller (parameter *nciLuxSetpoint* or *Setpoint*) to the desired light level (e.g. 400 lux).
- You can leave the default values for the remaining parameters. For a description of the constant light controller functionality and the parameters refer to Section 6.1.4 (CEA-709) and 6.2.4 (BACnet).
- To determine which sensors (occupancy & lux) are used as inputs to and which light groups are controlled by a constant light controller instance go to the **CLC Bindings** page (see Figure 38).
- Again, selected the DALI channel by clicking on the different tabs at the top of the page labeled **Channel 1**, **Channel 2**, etc.
- Click on the **Add** to add an input or output. Use the drop down box to select a sensor (input) or a light group (output). In our example we use “sensor\_306” for lux and occupancy sensor inputs, group “306\_corridor” as output of the first (brighter) light band and group “306\_window” as output for the second (darker) light band.

## 3.7 Configuration of BACnet Interface (LDALI-20X only)

### 3.7.1 Configure BACnet Interface

To allow integrating the L-DALI to a BACnet network a network wide unique device ID and device name must be configured. This is best done using the web interface:

1. Similar to the configuration of the IP address connect to the L-DALI using your Internet browser.
2. Click on **Config** and then **BACnet Config** in the left menu.

The screenshot displays the LOYTEC BACnet Configuration web interface. The top header shows the LOYTEC logo and the title 'BACnet Configuration'. The left sidebar indicates the user is logged in as 'admin' and provides a navigation menu with options like 'Device Info', 'Data', 'Commission', and 'Config'. The 'Config' menu is expanded, showing sub-options such as 'Port Config', 'E-mail', 'System', 'BACnet' (which is selected), 'Passwords', 'Backup/Restore', 'Debug', 'Firmware', and 'Documentation'. The main content area is titled 'BACnet Configuration' and features a 'Device' tab. The configuration fields include: 'Device ID' (86), 'Device name' (LDALI-ME204), 'Device description' (LDALI-ME204), 'Device location' (unknown), 'APDU timeout' (10 s), 'APDU segment timeout' (5 s), 'APDU retry count' (3), and 'APDU length accepted' (1476). A red warning message states '\* These settings must be specified and unique on the network.' Below the fields are 'Save Settings' and 'Get Settings' buttons.

Figure 39: BACnet Device Configuration.

3. Enter a unique device ID and device name as shown in Figure 39.

For further details see the LOYTEC Device User Manual [1].

# 4 Hardware Installation

## 4.1 Enclosure

### 4.1.1 LDALI-3E10X-U and LDALI-ME20X-U

The LDALI-3E10X-U and LDALI-ME20X-U enclosure is 159 mm wide for DIN rail mounting, following DIN 43 880 (see Figure 40).

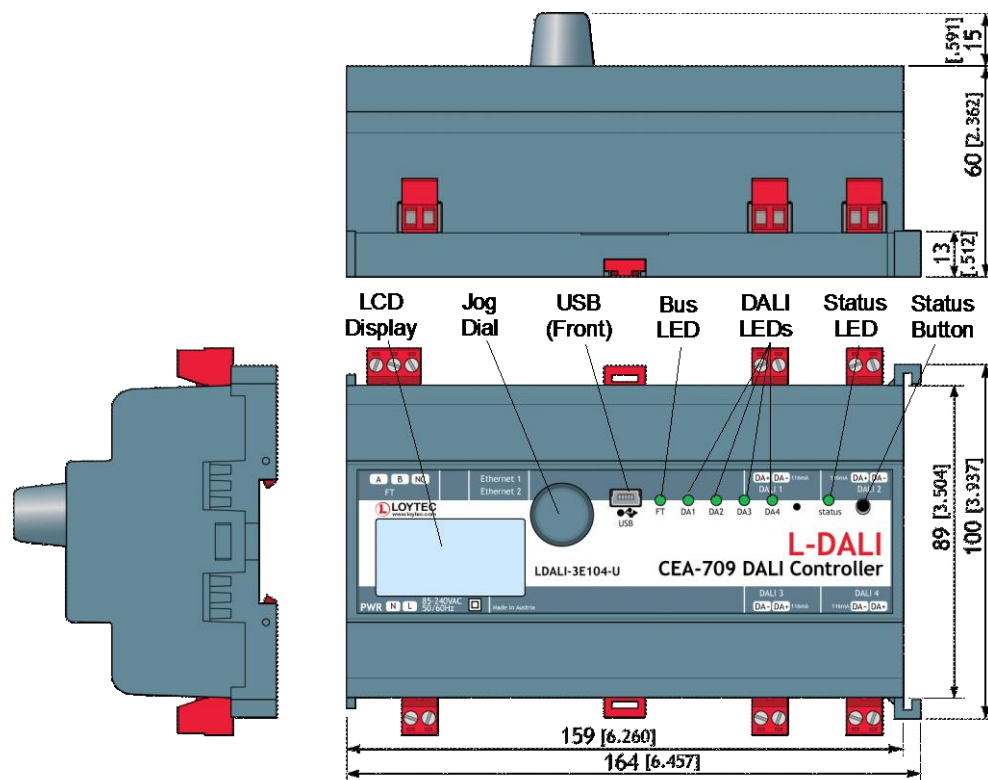

Figure 40: LDALI-3E10X-U and LDALI-ME204-U Enclosure (dimensions in mm [inch]).

### 4.1.2 LDALI-E101-U, LDALI-3101-U and LDALI-E101-U

The LDALI E101 U, LDALI 3101 U and LDALI E101 U enclosure is 107 mm wide for DIN rail mounting, following DIN 43 880 (see Figure 41).

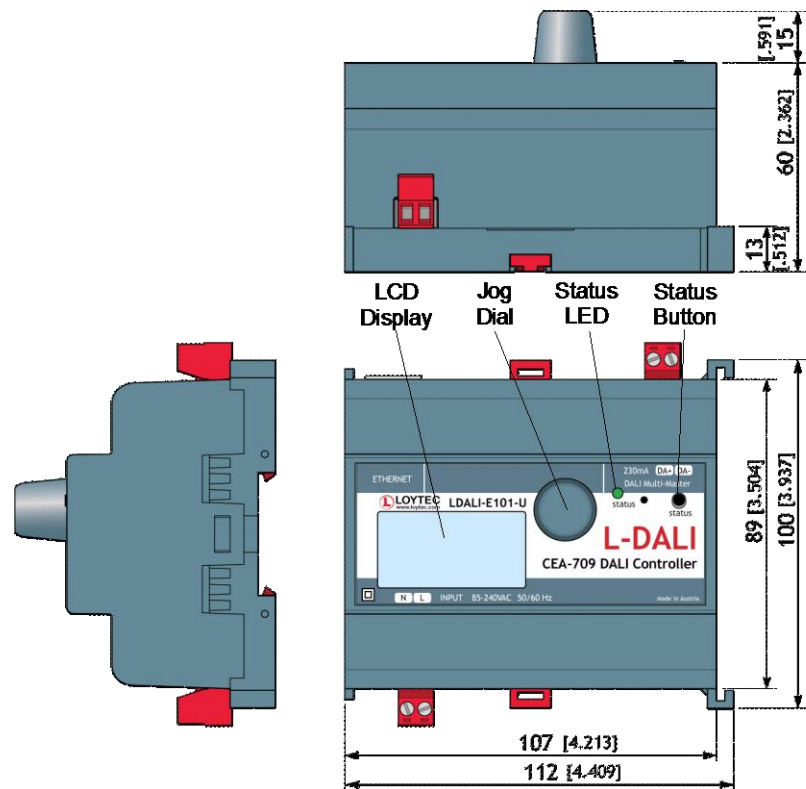

Figure 41: LDALI-E101-U, LDALI-3101-U and LDALI-E101-U Enclosure (dimensions in mm [inch]).

#### 4.1.3 LDALI-3E10X and LDALI-ME204

The LDALI-3E10X and LDALI-ME204 enclosure is 159 mm wide for DIN rail mounting, following DIN 43 880 (see Figure 42).

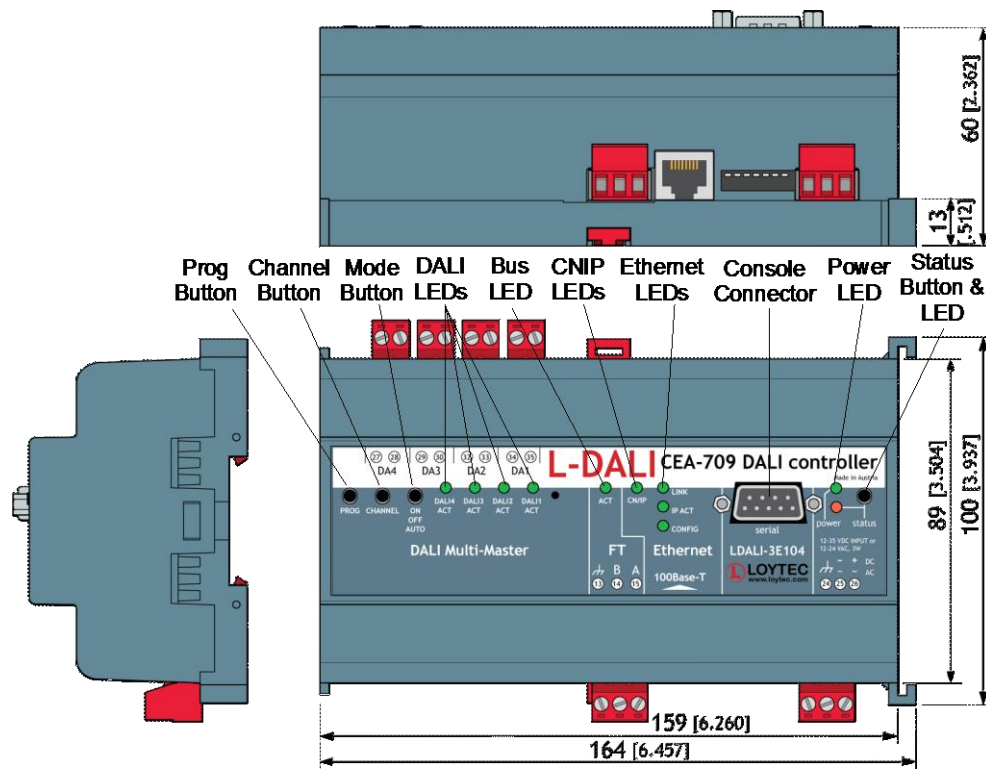

Figure 42: LDALI-3E10X and LDALI-ME204 Enclosure (dimensions in mm [inch]).

## 4.2 Product Label

The product label on the side of the L-DALI contains the following information:

- Order number (e.g. LDALI-3E104-U),
- Serial number with bar-code (Ser#).

Unless stated otherwise, all bar codes are encoded using “Code 128”. An additional label is also supplied with the L-DALI for documentation purposes. The specific contents of the product label are shown on the installation sheet found in the product’s box.

## 4.3 Mounting

The device comes prepared for mounting on DIN rails following DIN EN 50 022. The device can be mounted in any position. However, an installation place with proper airflow must be selected to ensure that the temperature of the L-DALI device does not exceed the specified range (see Chapter 8).

## 4.4 LED signals

### 4.4.1 LDALI-3E10X-U and LDALI-ME20X-U

#### 4.4.1.1 FT Activity LED (LDALI-10X only)

The FT port on the LDALI-3E10X-U has a three-color LED (green, red, and orange, see Figure 40). Table 2 shows different LED patterns of the port and their meaning.

Behavior	Description	Comment
GREEN flashing fast	Traffic	
GREEN flashing at 1Hz	L-DALI is unconfigured	
RED permanent	Port damaged	
RED flashing fast	Traffic with high amount of errors	
RED flashing at 1 Hz (all ports)	Firmware image corrupt Please upload new firmware	
ORANGE permanent	Port disabled	e.g. using LSD Tool

Table 2: CEA-709 Activity LED Patterns.

#### 4.4.1.2 MSTP Activity LED (LDALI-20X only)

The MS/TP port on the LDALI-ME20X-U has a three-color MSTP Activity LED (see Figure 40). Table 3 shows the different LED patterns of the port and their meaning. A permanent color reflects a state. Flicker is for 25 ms when there is activity on the MS/TP data link layer.

Behavior	Description	Comment
GREEN permanently, flicker off	Multi-Master, token ok, flicker when traffic	Normal condition on a multi-master MS/TP network.
ORANGE flicker	Sole master, flicker when traffic	Normal condition on a single-master MS/TP network.
RED permanent, flicker GREEN	Token lost state, flicker when transmit attempt	Cable might be broken.
RED flash fast	Transmission or receive errors	This indicates bad cabling.

Table 3: MS/TP Activity LED Patterns.

#### 4.4.1.3 DALI Activity LEDs

Each DALI interface on the L-DALI has a three color LED (green, red and orange). Table 4 shows different LED patterns and their meaning.

Behavior	Description
GREEN flashing	Traffic
RED flashing fast	Traffic with errors
RED permanent	No bus power-supply/bus-power supply failed
ORANGE permanent	Manual override to off or interface is selected
GREEN permanent	Manual override to on

Table 4: DALI Activity LED patterns.

#### 4.4.1.4 Status LED

On the LDALI-3E10X the Status LED is a three color LED that indicates different operating states of the L-DALI's CEA-852 device.

Green: The CEA-852 device is fully functional and all CEA-852 configuration data (channel routing info, channel membership list, send list) are up-to-date.

Green flicker: If a valid CEA-709 packet is received or transmitted over the IP channel, the CNIP LED turns off for 50 ms. Only valid CEA-709 IP packets sent to the IP address of the L-DALI can be seen. Stale packets or packets not addressed to the L-DALI are not seen.

Yellow: The CEA-852 device is functional but some configuration data is not up-to-date (device cannot contact configuration server but has configuration data saved in Flash memory)

Red: The CEA-852 device is non-functional because it was rejected from the CEA-852 IP channel or shut-down itself due to an internal error condition.

Off: The CEA-852 device is non-functional because it has not been started. This can be the case if the L-DALI uses DHCP and it has not received a valid IP configuration (address) from the DHCP server.

Flashing Red at 1 Hz: The CEA-852 device is non-functional because it is started but has not been configured. Please add the device to a CEA-852 IP channel (register in configuration server).

Flashing green or orange at 1 Hz: The L-DALI's CEA-709 side of the gateway has not been commissioned yet. The color indicates the CEA-852 IP channel status as described above.

On the LDALI-ME20X-U the Status LED reflects the status of the BACnet/IP communication. It flashes green for 25 ms when BACnet packets are transmitted or received over the BACnet/IP interface.

## 4.4.2 LDALI-3E10X and LDALI-ME204

### 4.4.2.1 Power LED

The L-DALI power LED lights up green when power is supplied to terminals 24, 25, and 26.

### 4.4.2.2 Status LED

The L-DALI is equipped with a red status LED (see Figure 42). This LED is normally off. During boot-up the status LED is used to signal error conditions (red). If the fall-back image is executed the status LED flashes red once every second.

### 4.4.2.3 FT Activity LED (LDALI-10X only)

The FT port on the LDALI-3E10X has a three-color LED (green, red, and orange, see Figure 42). Table 2 shows different LED patterns of the port and their meaning.

### 4.4.2.4 MSTP Activity LED (LDALI-20X only)

The MS/TP port on the LDALI-ME20X has a three-color MSTP Activity LED (see Figure 42). Table 3 shows the different LED patterns of the port and their meaning. A permanent color reflects a state. Flicker is for 25 ms when there is activity on the MS/TP data link layer.

### 4.4.2.5 Ethernet Link LED

The Ethernet Link LED lights up green whenever an Ethernet cable is plugged-in and a physical connection with a switch, hub, or PC can be established.

### 4.4.2.6 Ethernet Activity LED

The Ethernet Activity LED lights up green for 6 ms whenever a packet is transmitted or received or when a collision is detected on the network cable.



#### 4.4.2.7 Ethernet Config LED

Currently the Ethernet Config LED has no function.

#### 4.4.2.8 CN/IP LED

On the LDALI-3E10X the CNIP LED is a three color LED that indicates different operating states of the L-DALI's CEA-852 device.

**Green:** The CEA-852 device is fully functional and all CEA-852 configuration data (channel routing info, channel membership list, send list) are up-to-date.

**Green flicker:** If a valid CEA-709 packet is received or transmitted over the IP channel, the CNIP LED turns off for 50 ms. Only valid CEA-709 IP packets sent to the IP address of the L-DALI can be seen. Stale packets or packets not addressed to the L-DALI are not seen.

**Yellow:** The CEA-852 device is functional but some configuration data is not up-to-date (device cannot contact configuration server but has configuration data saved in Flash memory)

**Red:** The CEA-852 device is non-functional because it was rejected from the CEA-852 IP channel or shut-down itself due to an internal error condition.

**Off:** The CEA-852 device is non-functional because it has not been started. This can be the case if the L-DALI uses DHCP and it has not received a valid IP configuration (address) from the DHCP server.

**Flashing Red at 1 Hz:** The CEA-852 device is non-functional because it is started but has not been configured. Please add the device to a CEA-852 IP channel (register in configuration server).

**Flashing green or orange at 1 Hz:** The L-DALI's CEA-709 side of the gateway has not been commissioned yet. The color indicates the CEA-852 IP channel status as described above.

On the LDALI-ME20X the CNIP LED reflects the status of the BACnet/IP communication. It flashes green for 25 ms when BACnet packets are transmitted or received over the BACnet/IP interface.

#### 4.4.2.9 DALI Activity LEDs

Each DALI interface on the L-DALI has a three color LED (green, red and orange). Table 4 shows different LED patterns and their meaning.

### 4.4.3 LDALI-E101-U, LDALI-3101-U and LDALI-E101-U

#### 4.4.3.1 Status LED

The L-DALI has a three color status LED (green, red and orange). Table 5 shows different LED patterns and their meaning.

Behavior	Description
GREEN flashing	DALI Traffic
RED flashing fast	DALI Traffic with errors
RED permanent	DALI bus-power supply failed/short
ORANGE permanent	Manual override to off
GREEN permanent	Manual override to on

Table 5: Status LED patterns.

#### 4.4.4 Wink Action

If the L-DALI receives a wink command on any of its network ports, it shows a blink pattern on the

- CEA-709 or CNIP activity LEDs and the DALI activity LEDs (LDALI-3E10X and LDALI-ME204) or
- Status LED (LDALI-E101-U, LDALI-3101-U and LDALI-E101-U).

The LEDs turn green/orange/red (each 0.15 s). This pattern is repeated six times. After that, the activity LED of the DALI channel corresponding to the CEA-709 node on which the wink was received flashes orange six times. After that the L-DALI LEDs resume their normal behavior.

---

## 4.5 Buttons

### 4.5.1 Status Button

Some L-DALI models are equipped with a status button (see Figure 42). When pressing the status button shortly during normal operation of the L-DALI, it sends a “Service Pin Message” on every active CEA-709 node or a BACnet “I Am” message on all active BACnet data link layers respectively.

LDALI-10X only: Note that there is one CEA-709 node for each DALI channel and each has its own unique node ID (“Neuron ID”). Pressing the status button longer than 2 seconds will allow you to select the node to send out the “Service Pin Message” message: The DALI port LED of the currently selected node will light up orange. After 2 seconds the next available node will be selected. When the status button is released the “Service Pin Message” is sent out on the currently selected node.

As an alternative to pressing the status button, a service pin message can be sent via the Web interface (see LOYTEC Device User Manual [1]).

The status button can also be used to switch the device back to factory default state. Press the service button and power-cycle the device. Keep the button pressed until the LEDs illuminate orange permanently. Release the button within five seconds from that time on to reset the device to factory defaults.

### 4.5.2 DALI Mode Button

L-DALI without LCD display are equipped with a DALI mode button (“ON/OFF/AUTO”, see Figure 42). It is used to manually override the dim values of the attached DALI devices and constant light controller instances. Press it once and all DALI devices on the selected channels are switched on (“on mode”), press it again and all DALI devices on the selected channels are switched off (“off mode”), press it a third time and the selected channels go back to “auto mode”.

In the “on mode” and “off mode” the dim levels of the DALI devices and constant light controller instance cannot be changed via the CEA-709 or BACnet interface (“manual override”). In the “auto mode” the dim level of the DALI devices is controlled via the CEA-709 or BACnet interface respectively.

Channels are selected via the DALI Channel button (see Section 4.5.3). The current state of a DALI channel can be determined based on the corresponding DALI Activity LED (see Section 4.4.2.9).

The main purpose of the mode button is to test the wiring during installation of the DALI system.

### 4.5.3 DALI Channel Button

L-DALI without LCD display are equipped with a DALI Channel button (“CHANNEL”, see Figure 42). It is used to select a specific channel. All other functions which can be performed via the DALI button interface (e.g. select DALI mode, see Section 4.5.2) are applied only to the selected DALI channel(s).

By default all DALI channels are selected. If the DALI Channel button is pressed once the first channel is selected and the corresponding DALI Activity LED lights up orange. Now each time the button is pressed the next channel is selected. If the last DALI channel is selected and the button is pressed once again, all DALI channels are selected. If no button is pressed for more than 15 seconds, the current selection is canceled.

### 4.5.4 DALI Program Button

L-DALI without LCD display are equipped with a DALI Program button (“PROG”, see Figure 42). It is used to replace a broken ballast. When the button is pressed, the L-DALI scans the selected DALI channel for missing and unconfigured ballasts. If exactly one missing ballast and one unconfigured ballast are found on a channel, the unconfigured ballast is used to replace the missing ballast. That is, the unconfigured ballast is configured with the address and the configuration parameters of the missing ballast. If multiple missing ballasts or multiple unconfigured ballasts are found, the Web UI or LINX Configurator software must be used to replace the missing ballast(s) (see LOYTEC Device User Manual [1] and LINX Configurator User Manual [2]).

During the replace operation, the DALI Activity LED of the corresponding channel lights up orange. If the operation was successful, the LED lights up green for 0.5 seconds, if it failed, the LED lights up red for 0.5 seconds.

Which channels are selected can be controlled via the DALI Channel button (see Section 4.5.3).

---

## 4.6 DIP Switch Settings

L-DALI models without LCD display are equipped with a DIP switch. The DIP switch assignment is shown in Table 6. Please leave all switches at default state.

---

DIP Switch #	Function	Factory Default
1	Must be OFF	OFF
2	Must be OFF	OFF
3	Must be OFF	OFF
4	Must be OFF	OFF
5	Must be OFF	OFF
6	Must be OFF	OFF
7	Must be OFF	OFF

Table 6: DIP Switch Settings for L-DALI.

---

## 4.7 Wiring

The wiring information of the product and its terminal layout are shown on the installation sheet found in the product's box.

# 5 Workflows for the L-DALI

This section discusses a number of work flows for configuring the L-DALI in different use cases in addition to the simple use case in the quick-start scenario (see Chapter 3). The description is intended to be high-level and is depicted in flow diagrams. The individual steps refer to later sections, which describe each step in more detail. The following use cases are defined:

- On-Line using LINX Configurator (see Section 5.1.1)
- Off-Line (see Section 5.1.2)

## 5.1.1 On-Line

The flow diagram in Figure 43 shows the steps that need to be followed in order to configure the L-DALI when the device and the DALI network including all DALI devices (e.g. ballasts, sensors, etc.) are available on-line. For details on the LINX Configurator see LINX Configurator User Manual [2].

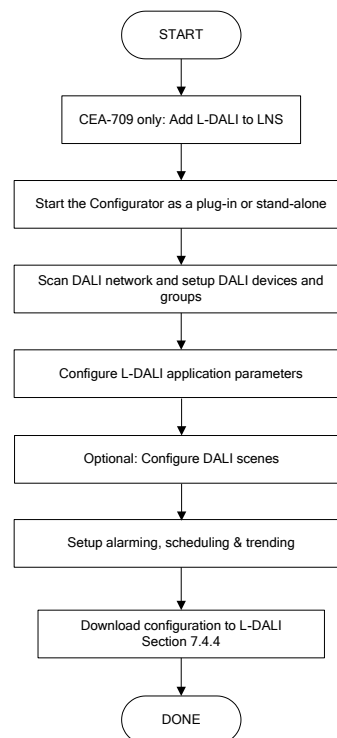

Figure 43: Basic on-line design-flow.

In case of LDALI-10x models are used in a LonWorks network, which is managed by an LNS network management tool, in the first step the L-DALI device must be added to LNS.

Then the LINX Configurator must be started to configure the L-DALI. Use Plug-In mode if working with an LNS based tool (CEA-709 only) or stand-alone mode otherwise. In the Configurator, the DALI network is scanned for DALI devices and the devices are setup and assigned to DALI groups. Then the parameters for the light application and the sunblind application can be configured. Optionally, DALI scenes and alarming, scheduling and trending functionality can be set up. Finally, the configuration needs to be downloaded to the L-DALI. It is recommended to save the complete configuration to a file for being able to replace an L-DALI in the network. Additionally a backup should be created.

To add more DALI devices, change DALI group assignment or application parameters simply repeat the steps described above.

### 5.1.2 Off-Line

The flow diagram in Figure 44 shows the steps that need to be followed in order to configure the L-DALI off-line. In this scenario the first steps can be performed without the L-DALI and the DALI network being physically available. This allows to prepare the on-line commissioning and thus to speed up the time required for on-site installation. Further, some steps of the on-line commissioning part can be performed by less skilled personnel using the L-DALI Web Interface.

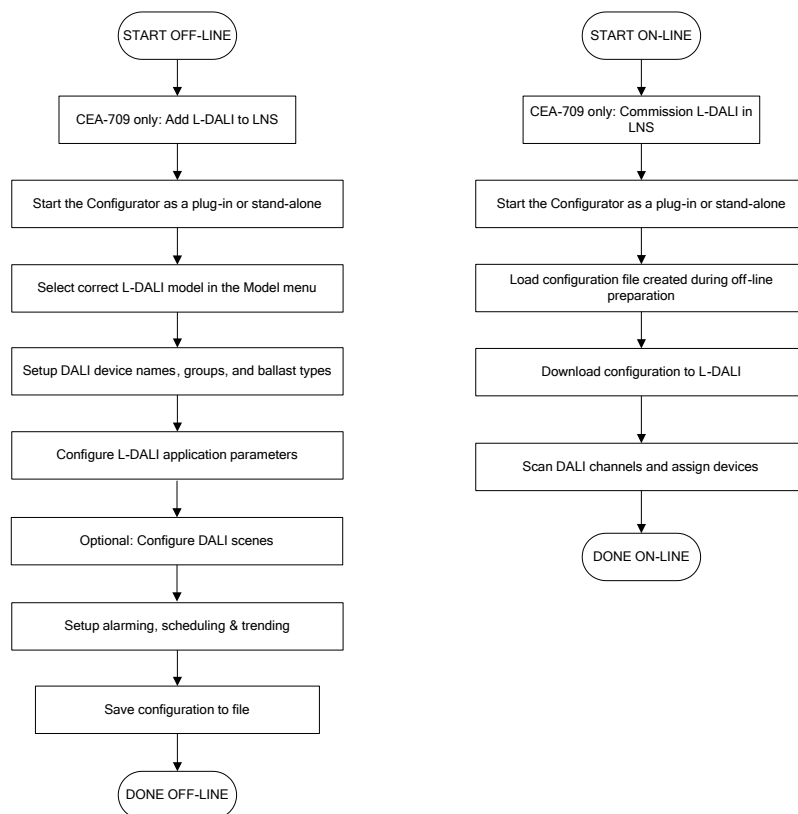

Figure 44: Basic off-line design-flow.

In case of LDALI-10x models are used in a LonWorks network, which is managed by an LNS network management tool, in the first step the L-DALI device must be added to LNS. Then the LINX Configurator must be started to configure the L-DALI. Use Plug-In mode if working with an LNS based tool (CEA-709 only) or stand-alone mode otherwise. Select the correct L-DALI model in the **Model** menu. Note, that the device is off-line. Next setup names, groups and optionally device type for the DALI devices. The names assigned must allow identifying physical devices later on (e.g. “Room 301-1” for first ballast in room 301). The device type (e.g. emergency light) must be selected if any device type specific parameters shall be configured in the next step. Then configure the parameters for the light

application and the sunblind application. Optionally, DALI scenes and alarming, scheduling and trending functionality can be set up. Save the created configuration to a file.

When the L-DALI is physically available, in case of a LDALI-10X model, first commission all ports of the device in LNS. Then again start the Configurator in plug-in mode. Load the file created during the off-line preparation and download the configuration to the L-DALI. Now, scan the DALI channels, either using the Configurator or the Web Interface and assign the DALI devices found to the names entered during off-line preparation. Finally, it is recommended to upload and save the complete configuration to a file for being able to replace an L-DALI in the network. Additionally a backup should be created.

To add more DALI devices, change DALI group assignment or application parameters it is recommended to use the on-line work flow (see Section 5.1.1).

### 5.1.3 Replace an L-DALI

An L-DALI can be replaced in the network by another unit. This might be necessary if a hardware defect occurs. If a backup of the latest configuration is available, restoring the backup is the best option.

The work flow to restore a device from the corresponding LINX Configurator project file is depicted in Figure 45. First of all, the replacement L-DALI needs to be configured with the appropriate IP settings and all relevant system settings (BACnet device ID, CEA-852 device settings, etc).

Start the LINX Configurator software stand-alone and connect via direct method. Load the LINX Configurator project file from the directory, which has been saved when the original L-DALI has been configured or modified. Double-check, if the DALI configuration seems ok and all DALI devices in use are assigned, that is, have a valid short address assigned. Then download the configuration to the L-DALI.

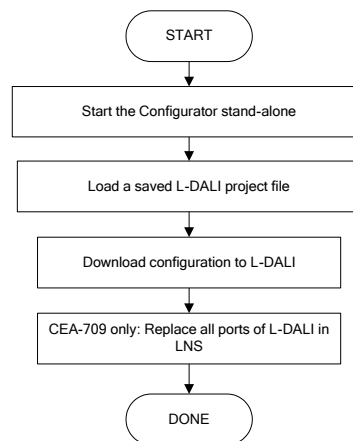

Figure 45: Basic work flow to configure a replacement device.

If using an LNS-based tool, all ports of the L-DALI device need to be replaced in that tool at some later point in time as the NID has changed. If you are not using LNS, then refer to your network management tool's reference manual on how to replace a device.

### 5.1.4 Enable Legacy NM Mode (LDALI-10X only)

For CEA-709/LonWorks network management tools, which do not support the ECS (extended command set) network management commands, the legacy network management mode must be configured. Please contact the tool's vendor for information whether ECS is supported or not. Note, that changing to legacy network management mode changes the static interface of the device and thus requires different XIF files.

The legacy mode can be enabled using the Web Interface (see LOYTEC Device User Manual [1]) or the **System Settings** tab in the **Project Settings** dialog of the Configurator Software (see LINX Configurator User Manual [2]).

### 5.1.5 Configuration Upload and Download

When uploading or downloading the configuration of an L-DALI device using the LINX Configurator the following items are available for download (see Figure 46):

- **Datapoint Configuration:** Contains everything configured on the Datapoints tab, the Local and Global connections tabs and in the project settings except for the system settings. Typically this includes local alarm, scheduler, calendar, and trendlog objects, e-mail templates, math objects and user created data points.

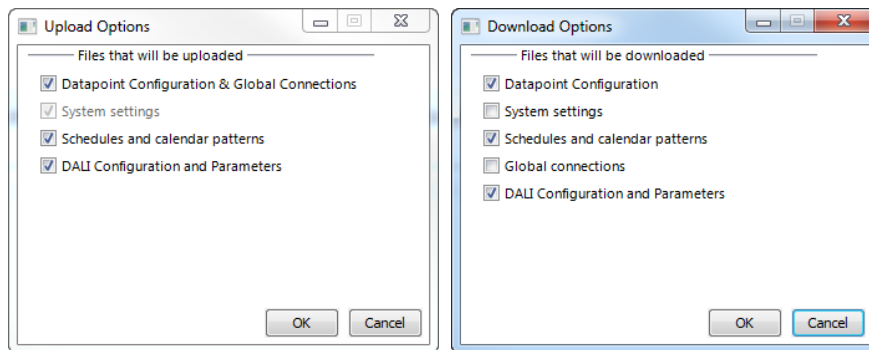

Figure 46: Upload and Download Options Dialog.

- **System settings:** Contains the configuration setup in the System Settings tab of the Project Settings.
- **Scheduler and calendar patterns:** Contains the schedule and calendar configuration (“contents” of scheduler and calendar objects).
- **Global connections:** Contains everything configured in the Global connections tab. Do not download Global connections using the LINX Configurator if using LWEB-900 software to configure and manage global connections!
- **DALI Configuration and Parameters:** The DALI Configuration contains the configuration of the DALI network, including device names, device types, device assignment (DALI short address), scene values, group names and group assignment as configured on the DALI Installation, DALI Groups, DALI Channel and DALI Scenes tabs. The Parameters contain the parameters of the L-DALI light and (if available) sunblind applications, including CLC Bindings and button functions as configured on the Parameters tab.

---

**Tip!**

*To speed up your work flow only download the configuration items changed. In applications where no AST features are used it is **sufficient to download DALI Configuration and Parameters!***

---



# 6 L-DALI Lighting Application

The L-DALI controllers come with a standard lighting application. The behavior of the application and the data points available are slightly different for the BACnet and the CEA-709 version of the L-DALI. The following sections describe the application, the data point interface available and the web interface specific for the L-DALI lighting application.

---

## 6.1 CEA-709 Interface and Application (LDALI-10X only)

Depending on the L-DALI device type 1 (LDALI-3E101-U/LDALI-E101-U/LDALI-3101-U), 2 (LDALI-3E102/ LDALI-3E102-U), or 4 (LDALI-3E104/ LDALI-3E104-U) DALI channels are supported. Each DALI channel is implemented as a separated CEA-709 node. Every one of these up to four CEA-709 nodes is a full grown CEA-709 node, including its own unique node id (“Neuron ID”), network address, network variable tables etc. However, all these nodes share one common physical network connection.

All configuration properties listed in this section are implemented as Configuration Parameters using configuration files (CPT, CPV, and CPC files). File access is provided via LONMARK FTP.

---

*Note:*

*It is recommended to start the LINX Configurator as LNS-Plug-In, whenever using a LDALI-10X with an LNS based network management tool (LonMaker, NL220, etc.)! This allows the Plug-In to keep the device configuration in-sync with the LNS database.*

---

The L-DALI can be used with different static network interface configurations. Depending on the application the different object types can be enabled or disabled to add functionality (e.g. button support or additional network variables for applications with emergency lights) or to reduce the number of objects, network variables and configuration properties respectively.

The interface configuration can be chosen via the Project Settings in the Configurator Software (see LINX Configurator User Manual [2]).

The LONMARK objects not specific to the L-DALI (Node Object, Real-Time Keeper Object, Calendar Object, Scheduler Object, etc.) are described in the LOYTEC Device User Manual [1].

### 6.1.1 Lamp actuator Object #3040

There are three different types of the lamp actuator objects:

- Lamp actuator object: related to DALI lamp (64 per channel)
- Group actuator object: related to DALI group (16 per channel).

- Channel actuator object: related to the DALI channel (1 per channel).

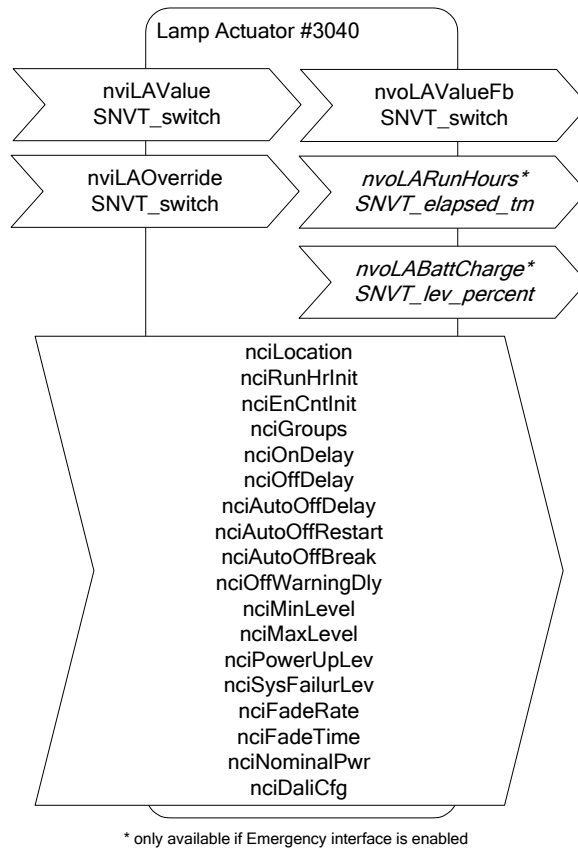

Figure 47: Lamp Actuator Object

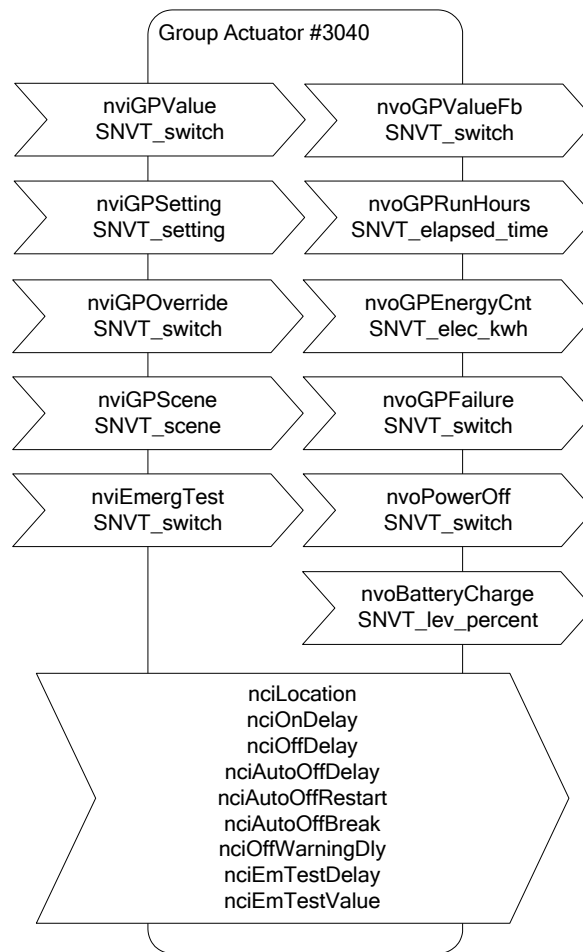

Figure 48: Group Actuator Object

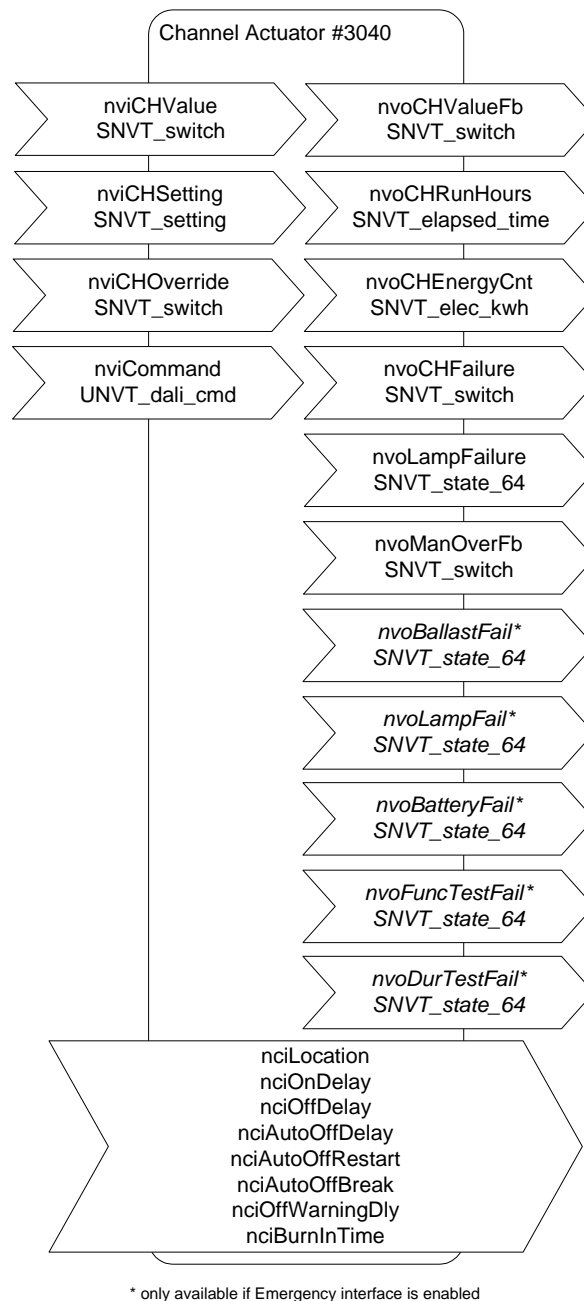

Figure 49: Object for channel

These object types are enabled in the default interface. They can be disabled.

---

*Note:* If the Lamp Actuator objects are disabled, the functional blocks are still present, but only contain the configuration properties corresponding to the DALI parameters of the corresponding ballast.

---

### 6.1.1.1 Control

The L-DALI offers different methods to control lamps. All network variables described below have the same priority. This means that the last network variable update determines the state of the lamp.

### Individual Control

Each lamp can be controlled individually via the switch input network variable *nviLValue* of the lamp actuator object. Any new value received is transmitting to the corresponding DALI lamp in fading mode (configuration property *nciFadeTime* is used).

### Group Control

Lamps belonging to a group can be controlled together by the following network variables of the group actuator object.

- ***nviGPValue***: This network variable has the same functionality as *nviLValue* but controls a whole group. Any new value received is transmitting to the DALI lamps in the group using fading mode (configuration property *nciFadeTime* is used).
- ***nviGPSetting***: Using this input network variable of type SNVT\_setting dimming devices can change the brightness relatively. By *function* = SET\_UP or *function* = SET\_DOWN the light is dimmed relatively by the amount defined in the corresponding *setting* field. By *function* = SET\_STOP ongoing fades are stopped. When the light is switched off by *function* = SET\_OFF, the last light level is saved temporarily. When the light is switched on again (*function* = SET\_ON) the remembered light level is restored. An absolute light level can be set by *function* = SET\_STATE. The corresponding *setting* field defines the target light level. The light value is changed in ramping mode (configuration property *nciFadeRate* is used).
- ***nviGPScene***: Using this input network variable of type SNVT\_scene up to 16 DALI scenes can be saved and recalled. The command SC\_LEARN stores the current light levels of all lamps of the group in the specified scene number. Alternatively DALI scenes can be configured using the DALI Scenes page in the web interface (see LOYTEC Device User Manual [1]) or the DALI Scenes tab in the LINX Configurator (see LINX Configurator User Manual [2]). By a SC\_RECALL command previously stored scenes can be recalled. Recalling scene 255 will relinquish any manual override and (re-)activate a constant light controller linked to the group (see Section 6.1.4.4). Scenes can be deleted by a SC\_RESET command. When a new scene is selected the lamp values are adjusted in fading mode (configuration property *nciFadeTime* is used).

### Channel Control

All lamps on the same DALI channel can be controlled together by the following network variables of the channel actuator object.

- ***nviCHValue***: This input network variable works in the same way as *nviLValue* and *nviGPValue* but affects all lamps on a channel.
- ***nviCHSetting***: This input network variable works in the same way as *nviGPSetting* but affects all lamps on a channel.

#### 6.1.1.2 Maximum and Minimum Light Level

For a dimmable lamp the maximum and minimum light level of a lamp can be configured via the configuration properties *nciMinLevel* and *nciMaxLevel* of type SNVT\_switch.

For a non-dimmable lamp set *nciMinLevel* = *nciMaxLevel* = 100%.

### 6.1.1.3 Timing Parameters

Figure 50 shows the behavior of the lamp actuator if the light is switched on/off via one of the switch (*nviLValue*, *nviGValue*, *nviCHValue*) or via one of the setting input network variables (*nviGASetting*, *nviCHSetting*). When the ON command is received, the lamp is switched to the specified value after the time *nciOnDelay* has expired. When the lamp is already on and a new ON command is received the lamp is switched to the new value immediately. If the lamp is on and an OFF command is received the lamp is switched off after the time *nciOffDelay*.

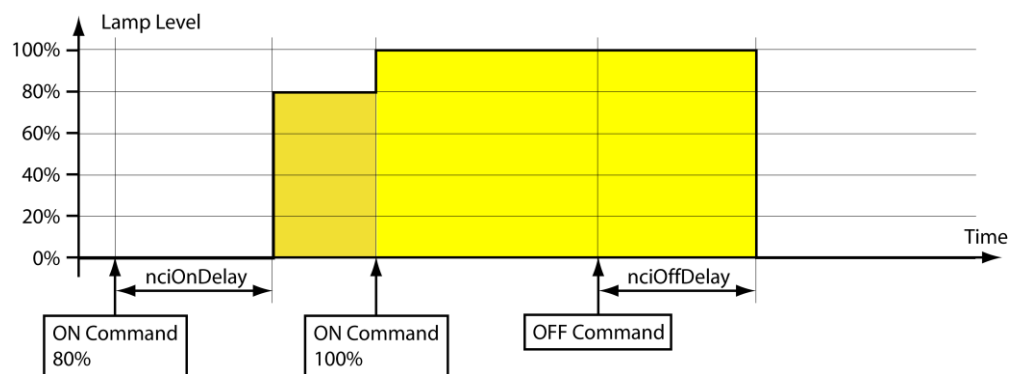

Figure 50: Timing Parameters

For staircase lighting an automatic cutoff can be configured in *nciAutoOffDelay* as shown in Figure 51. When this time expires, the lamp switches off automatically. To warn the user that the light is going to turn off, an off-warning delay (*nciOffWarningDly*) can be configured. During this time the light is dimmed to 50% of the previous level. For non-dimmable lights (*nciMinLevel=nciMaxLevel*) the light is blinking.

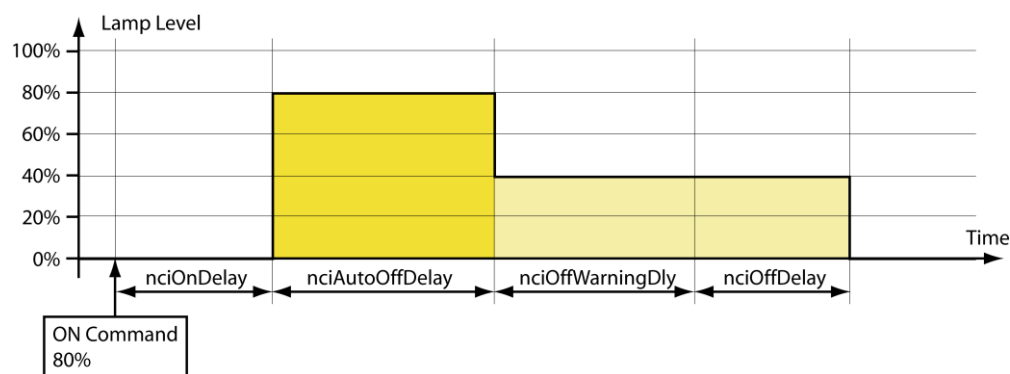
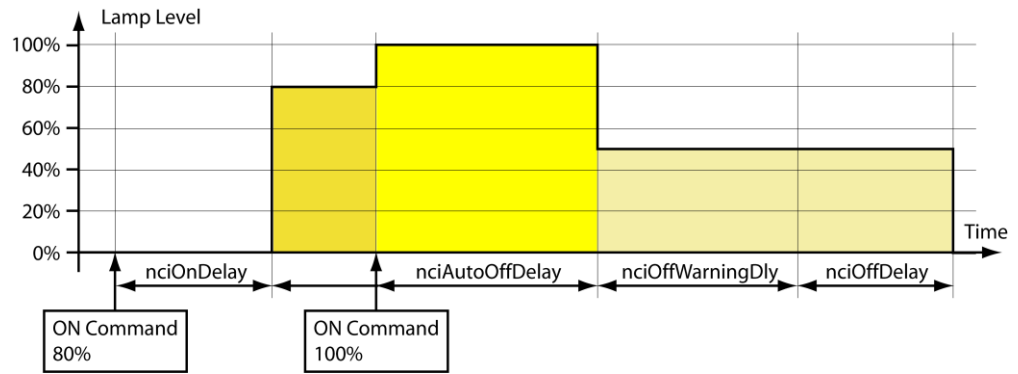
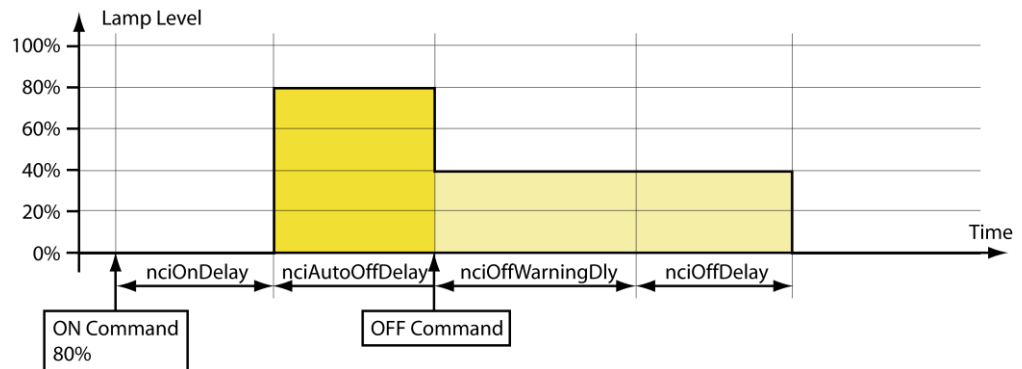

Figure 51: Timing Parameters with *nciAutoOffDelay* and *nciOffWarningDly*

The behavior of the auto-off timer can be modified with the two configuration properties *nciAutoOffRestart* and *nciAutoOffBreak*. If *nciAutoOffRestart* is set to *ST\_ON*, the auto-off timer can be restarted by a new ON command (see Figure 52). If *nciAutoOffBreak* is set to *ST\_ON* the auto-off timer can be stopped before the time has expired by switching the light off via one of the applicable input network variables (see Figure 53).

Figure 52: Timing Parameters (*nciAutoOffRestart=ST\_ON*)Figure 53: Timing Parameters (*nciAutoOffBreak=ST\_ON*)

#### 6.1.1.4 Prioritized Control

Lamp values can be overridden by the following network variables:

- ***nviLAOverride***: This input network variable of type SNVT\_switch overrides the value of *nviLAValue*.
- ***nviGPOVERRIDE***: This input network variable of type SNVT\_switch overrides the value of *nviGPValue*, *nviGPSetting*, and *nviGPScene*.
- ***nviCHOverride***: This input network variable of type SNVT\_switch overrides the value of *nviCHValue* and *nviCHSetting*.

If *nviXXOverride* is valid (.state=0/1) it controls the lamp/group/channel output. Updates of on the non-priorized input network variables (see Section 6.1.1.1) are ignored. If *nviXXOverride* is set to invalid (.state=-1) control of the lamp/group/channel output is returned to the non-priorized input network variable.

The light value is changed in fading mode (configuration property *nciFadeTime* is used).

Prioritized control commands are not affected by the timing parameters described in Section 6.1.1.3.

#### 6.1.1.5 Feedback

The lamp object, group object and channel object each report the current state via a feedback variable of type SNVT\_switch:

- ***nvoLAValueFb***: lamp object feedback

- *nvoGPValueFb*: group object feedback
- *nvoCHValueFb*: channel object feedback

The channel object reports if it is in manual override mode via the network variable *nvoManOverFb*.

### 6.1.1.6 Emergency Lights

The L-DALI supports testing of emergency lights using its CEA-709 interface. The test is started and stopped by using the network variable input *nviEmergTest*, which is available in each Group Actuator object. To start the test the *state* part of the *SNVT\_switch* must be set to SW\_ON (1). The *value* part selects one of the following tests:

- **Function test** (*value* = 1%): Starts the function test of all DALI emergency lights in this group, which support this function. For details on the DALI emergency lighting function test see IEC 62386-202. If the Emergency interface is enabled the *nvoFuncTestFail* will show whether the last function test performed has failed (see below).
- **Duration test** (*value* = 2 %): Starts the duration test of all DALI emergency lights in this group, which support this function. For details on the DALI emergency lighting duration test see IEC 62386-202. If the Emergency interface is enabled the *nvoDurTestFail* will show whether the last duration test performed has failed (see below).
- **Mains test** (*value* = 100%): Typically used in a central battery system, to verify lights are dimmed to the emergency level when mains fail. When the test is started via *nviEmergTest*, the power of the emergency lamps is cut by setting the switch network variable output *nvoPowerOff* to ON. After the delays *nciEmTestDelay*, the value of all lamps in the group is compared to the reference value specified in *nciEmTestValue*. If a lamp does not reach the reference value (dim value above or below reference value) or if a lamp is offline, an alarm is generated as shown in Figure 54.

Test results will be stored in the appropriate emergency light test log (see LOYTEC Device User Manual [1]). To abort any active test the *SNVT\_switch* must be set to {SW\_OFF, 0%}. To periodically execute tests a scheduler controlling *nviEmergTest* can be configured.

The screenshot shows the LOYTEC Alarm interface. The top bar displays the LOYTEC logo and the word "Alarm". Below this, the user is logged in as "admin" on device "LDALI-3E104". A sidebar on the left contains navigation options for "Device Info" and "Config", with "Alarm" selected. The main content area shows "Alarm Object Name: Local Alarms" and a "Summary" table:

State	Number
Active, not acknowledged	2
Active, acknowledged	0
Inactive, not acknowledged	0
Others	0

Below the summary is a "Details" table with columns: Alarm Time, Type, Priority, Description, Source Name, Value, and Ack.

Alarm Time	Type	Priority	Description	Source Name	Value	Ack
04.05.2010 12:30:26	fault	0	Emergency test failed	lamp_306_window_10		Ack
04.05.2010 12:30:26	fault	0	Emergency test failed	lamp_306_window_00		Ack

Figure 54: Emergency Light Test Alarm

If the interface configuration **Emergency** is selected the following additional, emergency light related network variables are available:



- *nvoLARunHour* (Lamp Actuator): Report run-hours per ballast.
- *nvoLABattCharge* (Lamp Actuator): Report battery charge per emergency light ballast (if ballast supports it).
- *nvoBatteryFail* (Channel Actuator): Report battery failure for each emergency light ballast.
- *nvoFuncTestFail* (Channel Actuator): Report whether last function test failed for each emergency light ballast.
- *nvoDurTestFail* (Channel Actuator): Report whether last function test failed for each emergency light ballast.

### 6.1.1.7 Status Monitoring

The L-DALI monitors the DALI lamps and reports any failure in the output network variables *nvoGPFailure* (group object) and *nvoCHFailure* (channel object).

A lamp failure is reported if either

- bus power for the related DALI channel fails,
- the DALI ballast is not reachable via the DALI channel, or
- the DALI ballast reports a failure (e.g. lamp failure) in its DALI status register.

The value of the network variable *nvoGPFailure* of the group object reflects the percentage of failed ballasts in this group.

The value of the network variable *nvoCHFailure* of the channel object reflects the percentage of failed ballasts in this channel.

The network variable *nvoLampFailure* of type SNVT\_state\_64 reports the status of the all lamps in a channel. Each bit corresponds to the lamp with the same index. In case of a failure the bit is set.

### 6.1.1.8 Statistics

The L-DALI reports the run hours and energy consumptions of the DALI lamps.

#### Run Hours

The L-DALI determines how long each DALI lamp was switched on. If a lamp is replaced the run hours can be initialized via the configuration property *nciRunHrInit* of the lamp object. To limit the number of network variables the run hours are reported not separately for each lamp but for a whole group or channel.

The group object reports the maximum run hours of all lamps in the groups via the output network variable *nvoGPRunHours*.

The channel object reports the maximum run hours of all lamps on the channel via the output network variable *nvoCHRunHours*.

#### Energy Consumption

The L-DALI device can calculate the energy consumption of the DALI lamps. For that purpose it needs to know the nominal power of all connected DALI lamps. If the configuration property *nciNominalPwr* of the lamp object is set to 0 (AUTO), the L-DALI tries to obtain the energy consumption from the DALI device. However, not all DALI

ballasts support this proprietary extension. In this case the *nciNominalPwr* has to be configured with the nominal power of the ballast. The energy consumption can be initialized via the configuration property *nciEnrgyCntInit* of the lamp object.

To reduce the number of network variables the energy consumption is reported not separately for each lamp but for a whole group or channel. The group object reports the sum of energy consumed by all lamps in the groups via the output network variable *nvoGPEnergyCnt*. Equally the network variable *nvoCHEnergyCnt* reports the sum of energy consumed by all lamps on the channel.

### 6.1.1.9 Burn-In Function

Some lamps require a burn-in time during which they must not be dimmed. The burn-in mode can be activated by setting the *nviCommand* network variable of the channel object to *START\_BURN\_IN*. The burn-in time is defined by the configuration property *nciBurnInTime*. During this time the lamps will only be switched to on (100%) or off (0%) but not dimmed. To abort the burn-in mode prematurely *nviCommand* can be set to *STOP\_BURN\_IN*.

### 6.1.1.10 Fail Safe Functions

The light level a lamp adopts after power-up is defined in the configuration property *nciPowerUpLev*.

The light level a lamp adopts in case of a DALI system failure is defined in the configuration property *nciSysFailureLev*.

### 6.1.1.11 Colour Control

Controlling the colour of devices of type “colour control” (device type 8) is possible via the *nviCommand* available on the Channel actuator object.

### 6.1.1.12 Input Network Variables

<b>nviXXValue</b>	
<b>Type</b>	SNVT_switch
<b>Valid Range</b>	.value: 0..100% .state: 0, 1 On: .state = 1 and .value > 0 Off: .state = 0 and .value=any or .state=1 and .value = 0
<b>Default Value</b>	-
<b>Description</b>	Used to control the lamp/group/channel. This input is effective only if <i>nviXXOverride.state</i> is invalid (-1). If an update is received on this network variable the corresponding DALI lamp/group/channel is dimmed in fading mode (constant time, configuration property <i>nciFadeTime</i> is used). Lamp actuator only: If an invalid value is received, the lamp adopts the level defined by the <i>nciSysFailurLev</i> .

<b>nviXXSetting</b>													
<b>Type</b>	SNVT_setting												
<b>Valid Range</b>	.function: SET_OFF, SET_ON, SET_UP, SET_DOWN, SET_STATE .setting: 0..100%												
<b>Default Value</b>	-												
<b>Description</b>	<p>Used to control the group/channel. This input is effective only if <i>nviXXOverride.state</i> is invalid (-1).</p> <table border="1"> <thead> <tr> <th>Function</th> <th>Description</th> </tr> </thead> <tbody> <tr> <td>SET_UP, SET_DOWN</td> <td>The light is dimmed relatively by the amount defined in the .setting field.</td> </tr> <tr> <td>SET_STOP</td> <td>Stop an ongoing fade.</td> </tr> <tr> <td>SET_OFF</td> <td>The light is switched off and the last light level is saved temporarily.</td> </tr> <tr> <td>SET_ON</td> <td>The light is switched on to the light level saved at the time of the last SET_OFF command.</td> </tr> <tr> <td>SET_STATE</td> <td>Set the light to the level defined by the .setting field.</td> </tr> </tbody> </table> <p>The light is dimmed in ramping mode (constant rate, configuration property <i>nciFadeRate</i> is used).</p>	Function	Description	SET_UP, SET_DOWN	The light is dimmed relatively by the amount defined in the .setting field.	SET_STOP	Stop an ongoing fade.	SET_OFF	The light is switched off and the last light level is saved temporarily.	SET_ON	The light is switched on to the light level saved at the time of the last SET_OFF command.	SET_STATE	Set the light to the level defined by the .setting field.
Function	Description												
SET_UP, SET_DOWN	The light is dimmed relatively by the amount defined in the .setting field.												
SET_STOP	Stop an ongoing fade.												
SET_OFF	The light is switched off and the last light level is saved temporarily.												
SET_ON	The light is switched on to the light level saved at the time of the last SET_OFF command.												
SET_STATE	Set the light to the level defined by the .setting field.												

<b>nviXXOverride</b>	
<b>Type</b>	SNVT_switch
<b>Valid Range</b>	.value: 0..100% .state: 0, 1, -1
<b>Default Value</b>	-
<b>Description</b>	<p>If <i>nviXXOverride</i> is valid (.state=0/1), the current lamp/group/channel output is saved temporarily and the lamp/group/channel output is set to the specified value.</p> <p>If <i>nviXXOverride</i> is set to invalid (.state=-1), the lamp/group/channel output is set to the previously saved value.</p> <p>The light is dimmed in fading mode (constant time, configuration property <i>nciFadeTime</i> is used).</p>

nviGPScene									
<b>Type</b>	SNVT_scene								
<b>Valid Range</b>	.function: SC_LEARN, SC_RECALL, SC_RESET .scene_number: 1..16, 255								
<b>Default Value</b>	-								
<b>Description</b>	<p>Using this input network variable up to 16 DALI scenes can be saved and recalled.</p> <table border="1"> <thead> <tr> <th>Function</th> <th>Description</th> </tr> </thead> <tbody> <tr> <td>SC_LEARN</td> <td>Stores the current light levels of all lamps of the group in the specified scene number.</td> </tr> <tr> <td>SC_RECALL</td> <td>Recall a previously stored scenes.</td> </tr> <tr> <td>SC_RESET</td> <td>Delete a scene.</td> </tr> </tbody> </table> <p>Recalling scene 255 will relinquish any manual override and (re-)activate a constant light controller linked to the group (see Section 6.1.4.4).</p> <p>When a new scene is selected the lamp values are adjusted in fading mode (configuration property <i>nciFadeTime</i> is used).</p>	Function	Description	SC_LEARN	Stores the current light levels of all lamps of the group in the specified scene number.	SC_RECALL	Recall a previously stored scenes.	SC_RESET	Delete a scene.
Function	Description								
SC_LEARN	Stores the current light levels of all lamps of the group in the specified scene number.								
SC_RECALL	Recall a previously stored scenes.								
SC_RESET	Delete a scene.								

nviEmergTest	
<b>Type</b>	SNVT_switch
<b>Valid Range</b>	.value: 0..100% .state: 0, 1
<b>Default Value</b>	-
<b>Description</b>	<p>Used to start the test of emergency lamps in a group. To start the test the <i>state</i> part of the <i>SNVT_switch</i> must be set to SW_ON (1). The <i>value</i> part selects one of the following tests:</p> <ul style="list-style-type: none"> <li>• <b>Function test</b> (value = 1%): Starts the function test of all DALI emergency lights in this group, which support this function. For details on the DALI emergency lighting function test see IEC 62386-202. If the Emergency interface is enabled the <i>nvoFuncTestFail</i> will show whether the last function test performed has failed.</li> <li>• <b>Duration test</b> (value = 2 %): Starts the duration test of all DALI emergency lights in this group, which support this function. For details on the DALI emergency lighting duration test see IEC 62386-202. If the Emergency interface is enabled the <i>nvoDurTestFail</i> will show whether the last duration test performed has failed.</li> <li>• <b>Mains test</b> (value = 100%): Typically used in a central battery system, to verify lights are dimmed to the emergency level when mains fail. When the test is started via <i>nviEmergTest</i>, the power of the emergency lamps is cut by setting the switch network variable output <i>nvoPowerOff</i> to ON. After the delays <i>nciEmTestDelay</i>, the value of all lamps in the group is compared to the reference value specified in <i>nciEmTestValue</i>. If a lamp does not reach the reference value (dim value above or below reference value) or if a lamp is offline, an alarm is generated as shown in Figure 54.</li> </ul> <p>Test results will be stored in the appropriate emergency light test log (see LINX Configurator User Manual [2]). To abort any active test the <i>SNVT_switch</i> must be set to {SW_OFF, 0%}.</p>

nviCommand									
<b>Type</b>	UNVT_dali_cmd								
<b>Valid Range</b>	.cmd: START_BURN_IN=0, STOP_BURN_IN=1, DALI_CMD_SET_COLOUR=2 .data.type: BALLAST=0, GROUP=1, CHANNEL=2 .data.index: 0..63 .data.arg: Union containing arguments depending on selected command.								
<b>Default Value</b>	-								
<b>Description</b>	<p>Used to start and stop the burn-in mode.</p> <table border="1"> <thead> <tr> <th>Function</th> <th>Description</th> </tr> </thead> <tbody> <tr> <td>START_BURN_IN</td> <td>Start the burn-in mode for a ballast, group, or channel. The burn-in time is defined by the configuration property <i>nciBurnInTime</i>.</td> </tr> <tr> <td>STOP_BURN_IN</td> <td>Abort the burn-in mode for a ballast, group, or channel.</td> </tr> <tr> <td>DALI_CMD_SET_COLOUR</td> <td> <p>Change light color for ballast, group, or channel. The argument field is defined as follows:</p> <pre> struct set_colour {     dali_colour_type_t type;     union value {         struct xy_coordinate {             uint16 x;             uint16 y;         };         uint16 colour_temperature_tc;         uint16 primary_n_dim_level[6];         struct rgbwaf {             uint8 control;             uint8 red;             uint8 green;             uint8 blue;             uint8 white;             uint8 amber;             uint8 freecolour;         };     }; }; </pre> <p>The field <i>type</i> defines the way the colour is specified:</p> <ul style="list-style-type: none"> <li>• DALI_COLOUR_TYPE_XY_COORDINATE (0): The light colour is defined by the x any y coordinates in the CIE1931 colour space chromaticity diagram. The x and y values are given in the structure <i>value.xy_coordinate</i>.</li> <li>• DALI_COLOUR_TYPE_TC (1): The light colour is defined by the colour temperature Tc. Its value is given in the field <i>value.colour_temperature_tc</i>.</li> <li>• DALI_COLOUR_TYPE_PRIMARY_N (2): The light colour is defined by the dim level of up to 6 channels. The corresponding values are given in the array <i>value.primary_n_dim_level</i>.</li> <li>• DALI_COLOUR_TYPE_RGBWAF (3): The light colour is defined by colour channels red, green, blue, white, amber and freecolour. See IEC 62386-209 on details. The corresponding values ar given in the structure <i>value.rgbwaf</i>.</li> </ul> <p><b>Note: Not all colour control types are supported by all DALI colour control ballasts. Check the documentation of the DALI ballast on which types are supported.</b></p> </td> </tr> </tbody> </table> <p>If the command requires an address the field <i>data.type</i> defines whether the command addresses a single ballast, a group or the all devices on the channel (broadcast). The field <i>data.index</i> gives the index of the associated lamp actuator (0-63) or group actuator (0-15) object, respectively. In case of type CHANNEL the index is ignored.</p>	Function	Description	START_BURN_IN	Start the burn-in mode for a ballast, group, or channel. The burn-in time is defined by the configuration property <i>nciBurnInTime</i> .	STOP_BURN_IN	Abort the burn-in mode for a ballast, group, or channel.	DALI_CMD_SET_COLOUR	<p>Change light color for ballast, group, or channel. The argument field is defined as follows:</p> <pre> struct set_colour {     dali_colour_type_t type;     union value {         struct xy_coordinate {             uint16 x;             uint16 y;         };         uint16 colour_temperature_tc;         uint16 primary_n_dim_level[6];         struct rgbwaf {             uint8 control;             uint8 red;             uint8 green;             uint8 blue;             uint8 white;             uint8 amber;             uint8 freecolour;         };     }; }; </pre> <p>The field <i>type</i> defines the way the colour is specified:</p> <ul style="list-style-type: none"> <li>• DALI_COLOUR_TYPE_XY_COORDINATE (0): The light colour is defined by the x any y coordinates in the CIE1931 colour space chromaticity diagram. The x and y values are given in the structure <i>value.xy_coordinate</i>.</li> <li>• DALI_COLOUR_TYPE_TC (1): The light colour is defined by the colour temperature Tc. Its value is given in the field <i>value.colour_temperature_tc</i>.</li> <li>• DALI_COLOUR_TYPE_PRIMARY_N (2): The light colour is defined by the dim level of up to 6 channels. The corresponding values are given in the array <i>value.primary_n_dim_level</i>.</li> <li>• DALI_COLOUR_TYPE_RGBWAF (3): The light colour is defined by colour channels red, green, blue, white, amber and freecolour. See IEC 62386-209 on details. The corresponding values ar given in the structure <i>value.rgbwaf</i>.</li> </ul> <p><b>Note: Not all colour control types are supported by all DALI colour control ballasts. Check the documentation of the DALI ballast on which types are supported.</b></p>
Function	Description								
START_BURN_IN	Start the burn-in mode for a ballast, group, or channel. The burn-in time is defined by the configuration property <i>nciBurnInTime</i> .								
STOP_BURN_IN	Abort the burn-in mode for a ballast, group, or channel.								
DALI_CMD_SET_COLOUR	<p>Change light color for ballast, group, or channel. The argument field is defined as follows:</p> <pre> struct set_colour {     dali_colour_type_t type;     union value {         struct xy_coordinate {             uint16 x;             uint16 y;         };         uint16 colour_temperature_tc;         uint16 primary_n_dim_level[6];         struct rgbwaf {             uint8 control;             uint8 red;             uint8 green;             uint8 blue;             uint8 white;             uint8 amber;             uint8 freecolour;         };     }; }; </pre> <p>The field <i>type</i> defines the way the colour is specified:</p> <ul style="list-style-type: none"> <li>• DALI_COLOUR_TYPE_XY_COORDINATE (0): The light colour is defined by the x any y coordinates in the CIE1931 colour space chromaticity diagram. The x and y values are given in the structure <i>value.xy_coordinate</i>.</li> <li>• DALI_COLOUR_TYPE_TC (1): The light colour is defined by the colour temperature Tc. Its value is given in the field <i>value.colour_temperature_tc</i>.</li> <li>• DALI_COLOUR_TYPE_PRIMARY_N (2): The light colour is defined by the dim level of up to 6 channels. The corresponding values are given in the array <i>value.primary_n_dim_level</i>.</li> <li>• DALI_COLOUR_TYPE_RGBWAF (3): The light colour is defined by colour channels red, green, blue, white, amber and freecolour. See IEC 62386-209 on details. The corresponding values ar given in the structure <i>value.rgbwaf</i>.</li> </ul> <p><b>Note: Not all colour control types are supported by all DALI colour control ballasts. Check the documentation of the DALI ballast on which types are supported.</b></p>								

## 6.1.1.13 Output Network Variables

nvoXXValueFb	
<b>Type</b>	SNVT_switch
<b>Valid Range</b>	.value: 0..100% .state: 0, 1 On: .state = 1 and .value > 0 Off: .state = 0 and .value=any or .state=1 and .value = 0
<b>Default Value</b>	-
<b>Description</b>	Feedback value of the lamp/group/channel object. For a lamp actuator object this value is the current state and percentage of level intensity of the corresponding DALI ballast. The <i>.state</i> part is -1 (invalid) if the ballast is not present. For a group actuator or channel actuator object this value changes, whenever all ballasts of the group/channel adopt the same dim vale.

nvoXXRunHours	
<b>Type</b>	SNVT_elapsed_tm
<b>Valid Range</b>	.day: 0..65534 .hour: 0..23 .minute: 0..59 .second: 0..59
<b>Default Value</b>	-
<b>Description</b>	Reports the run (ON) hours. L-DALI calculates the run hours of each DALI ballast. The network variable <i>nvoGPRunHours</i> reports the maximum run hours of the lamps in a group. The network variable <i>nvoCHRunHours</i> reports the maximum run hours of the lamps in a channel. The network variable <i>nvoLARunHours</i> reports the run hours of each lamp. This network variable is only present if the Emergency interface is enabled (see Section 6.1). To reduce the number of network variables, the value is not available as a network variable on the Standard interface. If a lamp is replaced the run hours of a lamp can be initialized using the configuration property <i>nciRunHrInit</i> . If the ballast is capable of maintaining the run hours by itself (e.g. some DALI emergency lights), resetting the run hours via <i>nciRunHrInit</i> will also reset the run hours counter in the ballast.

<b>nvoXXEnergyCnt</b>	
<b>Type</b>	SNVT_elec_kwh
<b>Valid Range</b>	0..65534 Resolution: 1kWh
<b>Default Value</b>	-
<b>Description</b>	<p>This network variable reports the energy consumption of a group or channel.</p> <p>L-DALI calculates the energy consumption of each DALI ballast. To reduce the number of network variables, the calculated value is not available as a network variable on the lamp actuator object but is used to calculate the total energy consumption for the group and channel actuator objects.</p> <p>The network variable <i>nvoGPEnergyCnt</i> reports the total energy consumption of all lamps in a group.</p> <p>The network variable <i>nvoCHEnergyCnt</i> reports the total energy consumption of all lamps in a channel.</p> <p>The nominal power of a lamp can be configured using the configuration property <i>nciNominalPwr</i>. The energy consumption of a lamp can be initialized with the configuration property <i>nciEnCntInit</i>.</p>

<b>nvoXXFailure</b>	
<b>Type</b>	SNVT_switch
<b>Valid Range</b>	.value: 0..100% .state: 0, 1, -1
<b>Default Value</b>	-
<b>Description</b>	<p>This network variable reports the status of the lamps in a group or channel.</p> <p>The network variable <i>nvoGPFailure</i> reports the percentage of failed ballasts in a group.</p> <p>The network variable <i>nvoCHFfailure</i> reports the percentage of failed ballasts in a channel.</p> <p>A ballast failure is reported if either</p> <ul style="list-style-type: none"> <li>• Bus power for the related DALI channel fails,</li> <li>• The DALI ballast is not reachable via the DALI channel, or</li> <li>• The DALI ballast reports a failure (e.g. lamp failure) in its DALI status register.</li> </ul>

<b>nvoPowerOff</b>	
<b>Type</b>	SNVT_switch
<b>Valid Range</b>	.value: 0, 100 .state: 0, 1
<b>Default Value</b>	-
<b>Description</b>	<p>This network variable is used during the emergency light test to cut the power.</p> <p>The power is cut with an ON value (100.0, 1) and reapplied with an OFF value (0.0, 0).</p>

<b>nvoLampFailure</b>	
<b>Type</b>	SNVT_state_64
<b>Valid Range</b>	.bit0: 0, 1 ... .bit63: 0, 1
<b>Default Value</b>	-
<b>Description</b>	This network variable reports the status of the ballasts in the channel. Each bit corresponds to the lamp with the same index. In case of a failure the bit is set. A failure occurs if the corresponding ballast is offline or if it indicates a lamp failure or a ballast failure.

<b>nvoBatteryCharge, nvoLABattCharge</b>	
<b>Type</b>	SNVT_lev_percent
<b>Valid Range</b>	-163.840..163.830 Resolution: 0.005
<b>Default Value</b>	-
<b>Description</b>	Reports the battery charge of a self-contained emergency light or a group of self-contained emergency lights (if supported by the emergency light). The network variable <i>nvoBatteryCharge</i> reports the minimum battery charge of the emergency lights in a group. The network variable <i>nvoLABattCharge</i> reports the battery charge of each self-contained emergency light. This network variable is only present if the Emergency interface is enabled (see Section 6.1). To reduce the number of network variables, the value is not available as a network variable on the Standard interface.

<b>nvoManOverFb</b>	
<b>Type</b>	SNVT_switch
<b>Valid Range</b>	.value: 0, 100 .state: 0, 1, -1 On: .state=1 and .value=100 Off: .state=0 and .value=0 Auto: .state=-1 and .value=0
<b>Default Value</b>	-
<b>Description</b>	This network variable reports the current state of manual override for a channel.

<b>nvoBallastFail</b>	
<b>Type</b>	SNVT_state_64
<b>Valid Range</b>	.bit0: 0, 1 ... .bit63: 0, 1
<b>Default Value</b>	-
<b>Description</b>	This network variable reports the status of the ballasts in the channel. Each bit corresponds to the ballast with the same index. In case the ballast indicates a ballast failure the bit is set.



<b>nvoLampFail</b>	
<b>Type</b>	SNVT_state_64
<b>Valid Range</b>	.bit0: 0, 1 ... .bit63: 0, 1
<b>Default Value</b>	-
<b>Description</b>	This network variable reports the status of the lamps in the channel. Each bit corresponds to the ballast with the same index. In case the ballast indicates a lamp failure the bit is set.

<b>nvoBatteryFail</b>	
<b>Type</b>	SNVT_state_64
<b>Valid Range</b>	.bit0: 0, 1 ... .bit63: 0, 1
<b>Default Value</b>	-
<b>Description</b>	This network variable reports the battery status of the self-contained emergency lights in the channel. Each bit corresponds to the ballast with the same index. In case the ballast indicates a battery failure the bit is set. Note, that this function is not supported by all types of self-contained emergency lights.

<b>nvoFuncTestFail</b>	
<b>Type</b>	SNVT_state_64
<b>Valid Range</b>	.bit0: 0, 1 ... .bit63: 0, 1
<b>Default Value</b>	-
<b>Description</b>	This network variable reports the result of the last function test performed by each self-contained emergency light in the channel. Each bit corresponds to the ballast with the same index. In case the ballast indicates a failed function test the bit is set. Note, that this function is not supported by all types of self-contained emergency lights.

nvoDurTestFail	
<b>Type</b>	SNVT_state_64
<b>Valid Range</b>	.bit0: 0, 1 ... .bit63: 0, 1
<b>Default Value</b>	-
<b>Description</b>	This network variable reports the result of the last duration test performed by each self-contained emergency light in the channel.  Each bit corresponds to the ballast with the same index. In case the ballast indicates a failed duration test the bit is set. Note, that this function is not supported by all types of self-contained emergency lights.

#### 6.1.1.14 Configuration Properties

All configuration properties listed in this section are implemented as Configuration Parameters using configuration files (CPT, CPV, and CPC files). File access is provided via LONMARK FTP.

nciLocation	
<b>Type</b>	SCPTLocation (SNVT_str_asc)
<b>Valid Range</b>	31 ASCII characters
<b>Default Value</b>	Lamp X/Group X/Channel X
<b>Description</b>	This configuration property can be used to specify the name of the lamp/group/channel.

nciRunHrInit	
<b>Type</b>	SCPTrunHrInit (SNVT_elapsed_tm)
<b>Valid Range</b>	.day: 0..65534 .hour: 0..23 .minute: 0..59 .second: 0..59
<b>Default Value</b>	0
<b>Description</b>	This configuration property is used to store or reset the initial value of the run hours counter <i>nvoRunHours</i> (only for lamp actuator objects).  To reset the value set it to its invalid value (all 0xFF).

nciEnCntInit	
<b>Type</b>	UCPTenrgyCntInit (SNVT_elec_whr_f)
<b>Valid Range</b>	0..3.40282E38 Wh
<b>Default Value</b>	0
<b>Description</b>	This configuration property is used to store or reset the initial value of the energy counter <i>nvoEnergyCnt</i> (only for a lamp actuator objects).  To reset the value set it to its invalid value (NaN).

nciGroups	
<b>Type</b>	UCPTgroups (SNVT_state)
<b>Valid Range</b>	.bit0: 0, 1 ... .bit15: 0, 1
<b>Default Value</b>	0
<b>Description</b>	This configuration property defines the group membership of a lamp. Each bit corresponds to the group of the same index. If the bit is set, the lamp is member of the group.

nciOnDelay	
<b>Type</b>	UCPTonDelay (SNVT_time_sec)
<b>Valid Range</b>	0..6553.4 sec Resolution: 0.1 sec
<b>Default Value</b>	0
<b>Description</b>	This configuration property determines the delay after which the lamp value output is switched on.

nciOffDelay	
<b>Type</b>	UCPTOffDelay (SNVT_time_sec)
<b>Valid Range</b>	0..6553.4 sec Resolution: 0.1 sec
<b>Default Value</b>	0
<b>Description</b>	This configuration property determines the delay after which the lamp value output is switched off.

nciAutoOffDelay	
<b>Type</b>	UCPTautoOffDelay (SNVT_time_sec)
<b>Valid Range</b>	0..6553.4 sec Resolution: 0.1 sec 0s means disabled (no delay)
<b>Default Value</b>	0
<b>Description</b>	This configuration property determines the delay after which the lamp output is switched off automatically. The timer is started after receiving a lamp ON command via the <i>nviXXValue</i> or <i>nviXXSetting</i> network variable inputs.  The configuration properties <i>nciAutoOffRestart</i> and <i>nciAutoOffBreak</i> modify the behavior of the auto-off timer.

nciAutoOffRestart							
<b>Type</b>	UCPTautoOffRestart (SNVT_lev_disc)						
<b>Valid Range</b>	ST_ON, ST_OFF						
<b>Default Value</b>	ST_OFF						
<b>Description</b>	<p>This configuration property determines if the auto off timer can be restarted by an ON command via the <i>nviXXValue</i> or <i>nviXXSetting</i> network variable inputs.</p> <table border="1"> <thead> <tr> <th>Function</th> <th>Description</th> </tr> </thead> <tbody> <tr> <td>ST_ON</td> <td>While the auto-off timer is running, the timer can be restarted by an ON command via the <i>nviXXValue</i> or <i>nviXXSetting</i> network variable inputs.</td> </tr> <tr> <td>ST_OFF</td> <td>While the auto-off timer is running, all ON command via the <i>nviXXValue</i> or <i>nviXXSetting</i> network variable inputs are ignored.</td> </tr> </tbody> </table>	Function	Description	ST_ON	While the auto-off timer is running, the timer can be restarted by an ON command via the <i>nviXXValue</i> or <i>nviXXSetting</i> network variable inputs.	ST_OFF	While the auto-off timer is running, all ON command via the <i>nviXXValue</i> or <i>nviXXSetting</i> network variable inputs are ignored.
Function	Description						
ST_ON	While the auto-off timer is running, the timer can be restarted by an ON command via the <i>nviXXValue</i> or <i>nviXXSetting</i> network variable inputs.						
ST_OFF	While the auto-off timer is running, all ON command via the <i>nviXXValue</i> or <i>nviXXSetting</i> network variable inputs are ignored.						

nciAutoOffBreak							
<b>Type</b>	UCPTautoOffBreak (SNVT_lev_disc)						
<b>Valid Range</b>	ST_ON, ST_OFF						
<b>Default Value</b>	ST_OFF						
<b>Description</b>	<p>This configuration property determines if the auto off timer can be aborted prematurely by an OFF command via the <i>nviXXValue</i> or <i>nviXXSetting</i> network variable inputs.</p> <table border="1"> <thead> <tr> <th>Function</th> <th>Description</th> </tr> </thead> <tbody> <tr> <td>ST_ON</td> <td>While the auto-off timer is running, the timer can be aborted prematurely by an OFF command via the <i>nviXXValue</i> or <i>nviXXSetting</i> network variable inputs.</td> </tr> <tr> <td>ST_OFF</td> <td>While the auto-off timer is running, all OFF command via the <i>nviXXValue</i> or <i>nviXXSetting</i> network variable inputs are ignored.</td> </tr> </tbody> </table>	Function	Description	ST_ON	While the auto-off timer is running, the timer can be aborted prematurely by an OFF command via the <i>nviXXValue</i> or <i>nviXXSetting</i> network variable inputs.	ST_OFF	While the auto-off timer is running, all OFF command via the <i>nviXXValue</i> or <i>nviXXSetting</i> network variable inputs are ignored.
Function	Description						
ST_ON	While the auto-off timer is running, the timer can be aborted prematurely by an OFF command via the <i>nviXXValue</i> or <i>nviXXSetting</i> network variable inputs.						
ST_OFF	While the auto-off timer is running, all OFF command via the <i>nviXXValue</i> or <i>nviXXSetting</i> network variable inputs are ignored.						

nciOffWarningDly	
<b>Type</b>	UCPToffWarningDly (SNVT_time_sec)
<b>Valid Range</b>	<p>0..6553.4 sec</p> <p>Resolution: 0.1 sec</p> <p>0s means disabled (no delay)</p>
<b>Default Value</b>	0
<b>Description</b>	<p>This configuration property defines the time during which the user will be notified that the light will be switched off shortly. During this time, the light is dimmed to 50% of the current level. Lamps which cannot be dimmed (<i>nciMinLevel</i> = <i>nciMaxLevel</i>) blink during this time.</p>

<b>nciMinLevel</b>	
<b>Type</b>	UCPTminLevel (SNVT_lev_cont)
<b>Valid Range</b>	0..100% Resolution: 0.5
<b>Default Value</b>	0.1%
<b>Description</b>	This configuration property specifies the minimum dim level of a lamp. Corresponds to the DALI-Register MIN LEVEL.

<b>nciMaxLevel</b>	
<b>Type</b>	UCPTmaxLevel (SNVT_lev_cont)
<b>Valid Range</b>	0..100% Resolution: 0.5
<b>Default Value</b>	100%
<b>Description</b>	This configuration property specifies the maximum dim level of a lamp. Corresponds to the DALI-Register MAX LEVEL.

<b>nciPowerUpLev</b>	
<b>Type</b>	UCPTpowerUpLevel (SNVT_lev_cont)
<b>Valid Range</b>	0..100% (for some ballasts 0% is not allowed) Resolution: 0.5
<b>Default Value</b>	100%
<b>Description</b>	Initial dim level of DALI lamp after power has been applied to lamp. Corresponds to the DALI-Register POWER ON LEVEL.

<b>nciSysFailurLev</b>	
<b>Type</b>	UCPTsysFailureLevel (SNVT_lev_cont)
<b>Valid Range</b>	0..100% Resolution: 0.5 255/invalid value means keep current dim level
<b>Default Value</b>	100%
<b>Description</b>	This configuration property determines the dim value of a DALI lamp in case of a DALI system failure. Corresponds to the DALI-Register SYSTEM FAILURE LEVEL.

<b>nciFadeRate</b>	
<b>Type</b>	UCPTfadeRate
<b>Valid Range</b>	2.8..360 steps/s
<b>Default Value</b>	45 steps/s
<b>Description</b>	This configuration property determines the fade rate of a lamp in percent per second in ramping mode. Corresponds to the DALI-Register FADE RATE.

nciFadeTime	
<b>Type</b>	UCPTfadeTime (SNVT_time_sec)
<b>Valid Range</b>	0..100 sec
<b>Default Value</b>	0 sec
<b>Description</b>	This configuration property determines the duration of a fade time in fading mode. Corresponds to the DALI-Register FADE TIME.

nciNominalPwr	
<b>Type</b>	UCPTnominalPwr (SNVT_power)
<b>Valid Range</b>	0..6553.5 W Resolution: 0.1 W 0 means AUTO
<b>Default Value</b>	AUTO
<b>Description</b>	This configuration property specifies the nominal power of the lamp. It is used to calculate the energy consumption.  Some DALI ballasts can report their nominal power. In this case the configuration property should be set to 0 (AUTO).

nciEmTestDelay	
<b>Type</b>	UCPTtestDelay (SNVT_time_sec)
<b>Valid Range</b>	0..6553.4 sec Resolution: 0.1 sec
<b>Default Value</b>	0
<b>Description</b>	This configuration property is used for the emergency light test which is started by the network variable input <i>nviEmergTest</i> . It defines the time after which the dim level of the emergency lamps is compared with the reference value <i>nciEmTestValue</i> .

nciEmTestValue	
<b>Type</b>	UCPTtestValue (SNVT_lev_cont)
<b>Valid Range</b>	0..100% Resolution: 0.5
<b>Default Value</b>	0
<b>Description</b>	This configuration property is used for the emergency light test which is started by the network variable input <i>nviEmergTest</i> . It defines the reference value to which the dim level of the emergency lamps will be compared.

nciBurnInTime	
<b>Type</b>	UCPTburnInTime (SNVT_time_hour)
<b>Valid Range</b>	0..65,535 h
<b>Default Value</b>	100 h
<b>Description</b>	This configuration defines the burn-in time for new lamp. The burn-in mode is started via the network variable input <i>nviCommand</i> .

nciDaliCfg	
<b>Type</b>	UCPTdaliCfg
<b>Valid Range</b>	-
<b>Default Value</b>	-
<b>Description</b>	This configuration property contains the device type specific DALI-Registers. It is only available if the device type of a device is known, either because it was assigned or because the device type was set in the DALI Installation tab.

### 6.1.2 Light Sensor Object #1010

The L-DALI provides 16 light sensor objects for each DALI channel. A light sensor object makes the measured lux level of a DALI light sensor available on the CEA-709 network.

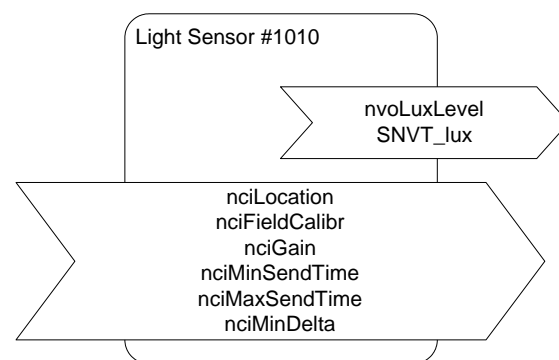

Figure 55: Light Sensor Object

This object type is enabled in the default interface. It can be disabled (together with the Occupancy Sensor objects).

#### 6.1.2.1 Sensor Calibration

To provide a reliable measurement the light sensor needs to be calibrated. The calibration is best performed with the LINX Configurator software (see LINX Configurator User Manual [2]) or using the Web Interface (see LOYTEC Device User Manual [1]).

#### 6.1.2.2 Output Network Variables

nvoLuxLevel	
<b>Type</b>	SNVT_lux
<b>Valid Range</b>	0..65,335 lux
<b>Default Value</b>	0
<b>Description</b>	This network variable provides the lux level measured by the light sensor. If no corresponding light sensor is present on the DALI network the value is 0.

#### 6.1.2.3 Configuration Properties

All configuration properties listed in this section are implemented as Configuration Parameters using configuration files (CPT, CPV, and CPC files). File access is provided via LONMARK FTP.

nciLocation	
<b>Type</b>	SCPTLocation (SNVT_str_asc)
<b>Valid Range</b>	31 ASCII characters
<b>Default Value</b>	Sensor X
<b>Description</b>	This configuration property can be used to specify the name of the light sensor.

nciFieldCalibr	
<b>Type</b>	UCPTfieldCalibArray
<b>Valid Range</b>	.index: 0..6 .value: 0..65,535 lux
<b>Default Value</b>	0/0
<b>Description</b>	<p>This configuration property is used to calibrate the light sensor. To counter any non-linearity the sensor can be calibrated under up to seven different illumination levels (table with index 0-6).</p> <p>The <i>.index</i> field specifies the index into the gain table (<i>nciGain</i>) for different illumination levels.</p> <p>The <i>.value</i> field is used to specify the lux value measured with an external luxmeter. It is used together with the lux value reported by the sensor to compute the corresponding entry in the gain table.</p> <p>When reading the value from the device (CP upload) the value 0/0 will be returned. Writing this value will be ignored. This protects the calibration values from accidentally being overwritten during (re-)commissioning.</p>

nciGain	
<b>Type</b>	UCPTgainArray
<b>Valid Range</b>	.gain_mul[7]: 0..65,535 lux .gain_div[7]: 0..65,535 lux
<b>Default Value</b>	All 0/0.
<b>Description</b>	<p>This configuration property is used to store the calibration data.</p> <p>.gain_mul[i] contains the lux value measured by a luxmeter.</p> <p>.gain_div[i] contains the lux value measured by the light sensor.</p> <p>Default values 0/0 are ignored.</p>

nciMinSendTime	
<b>Type</b>	SCPTminSendTime (SNVT_time_sec)
<b>Valid Range</b>	0..6553.4 sec Resolution: 0.1 sec
<b>Default Value</b>	1.0 sec
<b>Description</b>	Minimum time between updates of the <i>nvoLuxLevel</i> output.



nciMaxSendTime	
<b>Type</b>	SCPTmaxSendTime (SNVT_time_sec)
<b>Valid Range</b>	0..6553.4 sec Resolution: 0.1 sec
<b>Default Value</b>	60.0 sec
<b>Description</b>	Maximum time between updates of the <i>nvoLuxLevel</i> output (heartbeat functionality).

nciMinDelta	
<b>Type</b>	SCPTminDeltaLevel (SNVT_lev_cont)
<b>Valid Range</b>	0..100% Resolution: 0.5
<b>Default Value</b>	2.5%
<b>Description</b>	This configuration property specifies the amount by which the lux level must change before <i>nvoLuxLevel</i> is updated.

### 6.1.3 Occupancy Sensor Object #1060

The L-DALI provides 16 occupancy sensor objects for each DALI channel. The occupancy sensor object makes the state of a DALI occupancy sensor available on the CEA-709 network.

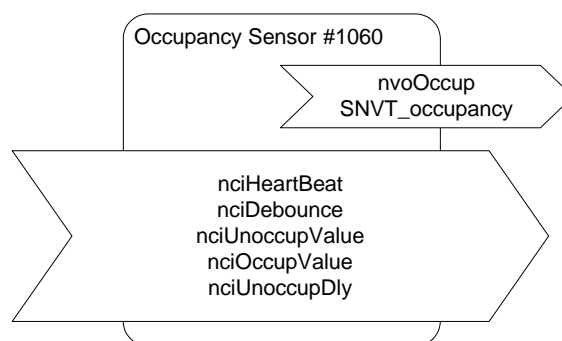

Figure 56: Occupancy Sensor Object.

This object type is enabled in the default interface. It can be disabled (together with the Light Sensor objects).

#### 6.1.3.1 Timing Description

The timing diagram shown in Figure 57 defines the different timers used by the occupancy sensor object.

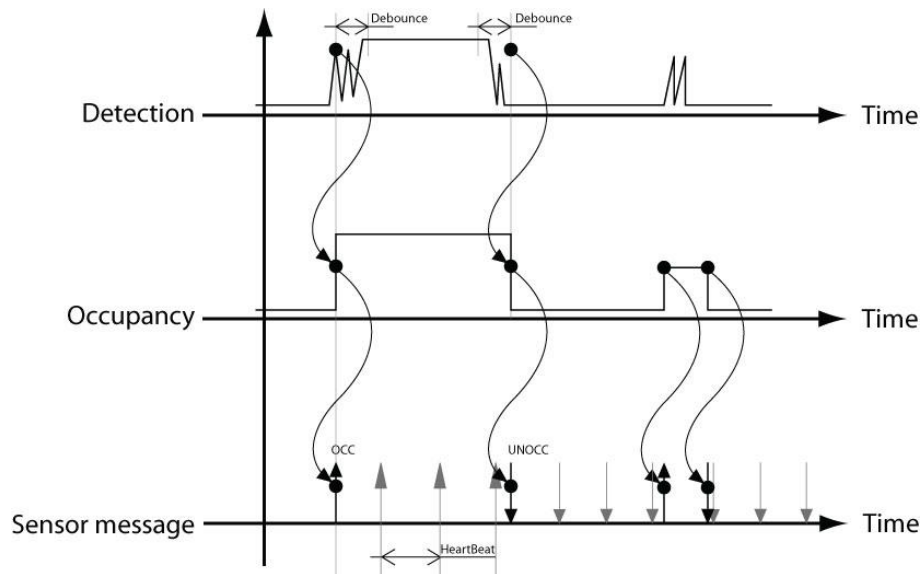

Figure 57: Timing of occupancy detection.

### 6.1.3.2 Output Network Variables

nvoOccup	
<b>Type</b>	SNVT_occupancy
<b>Valid Range</b>	OC_NUL (-1): Invalid Value OC_OCCUPIED (0): Area is occupied OC_UNOCCUPIED (1): Area is unoccupied OC_BYPASS (2): Area is temporarily occupied for the bypass period OC_STANDBY (3): Area is temporarily unoccupied
<b>Default Value</b>	OC_NUL
<b>Description</b>	This network variable provides the occupancy state measured by the occupancy sensor. If no corresponding occupancy sensor is present on the DALI network the value is OC_NUL.

### 6.1.3.3 Configuration Properties

All configuration properties listed in this section are implemented as Configuration Parameters using configuration files (CPT, CPV, and CPC files). File access is provided via LONMARK FTP.

nciHeartBeat	
<b>Type</b>	SCPHeartbeat (SNVT_time_sec)
<b>Valid Range</b>	0..6553.4 sec Resolution: 0.1 sec
<b>Default Value</b>	120.0 sec
<b>Description</b>	Maximum period of time that expires before the object automatically transmits the present value of the <i>nvoOccup</i> output NV.

nciDebounce	
<b>Type</b>	SCPTdebounce (SNVT_time_sec)
<b>Valid Range</b>	0..6553.4 sec Resolution: 0.1 sec
<b>Default Value</b>	0 sec
<b>Description</b>	Debouncing time to generate the detection envelope for occupancy detection and the OCCUPIED and NON OCCUPIED message.

nciUnoccupValue	
<b>Type</b>	UCPTunoccupiedValue (SNVT_occupancy)
<b>Valid Range</b>	OC_NUL (-1): Invalid Value OC_OCCUPIED (0): Area is occupied OC_UNOCCUPIED (1): Area is unoccupied OC_BYPASS (2): Area is temporarily occupied for the bypass period OC_STANDBY (3): Area is temporarily unoccupied
<b>Default Value</b>	OC_UNOCCUPIED
<b>Description</b>	This configuration property defines what value is transmitted via <i>nvoOccup</i> when the sensor detects that the room is unoccupied.

nciOccupValue	
<b>Type</b>	UCPToccupiedValue (SNVT_occupancy)
<b>Valid Range</b>	OC_NUL (-1): Invalid Value OC_OCCUPIED (0): Area is occupied OC_UNOCCUPIED (1): Area is unoccupied OC_BYPASS (2): Area is temporarily occupied for the bypass period OC_STANDBY (3): Area is temporarily unoccupied
<b>Default Value</b>	OC_OCCUPIED
<b>Description</b>	This configuration property defines what value is transmitted via <i>nvoOccup</i> when the sensor detects that the room is occupied.

nciUnoccupDly	
<b>Type</b>	UCPTunoccupDly (SNVT_time_sec)
<b>Valid Range</b>	0..6553.4 sec Resolution: 0.1 sec 0s means disabled (no delay)
<b>Default Value</b>	0 sec
<b>Description</b>	This configuration property specifies the delay after which <i>nvoOccup</i> adopts the unoccupied value. The timer is started when the occupancy sensor detects that the room is unoccupied

#### 6.1.4 Constant Light Controller Object #3050

The L-DALI provides 16 constant light controller objects with built in occupancy controller functionality for each DALI channel.

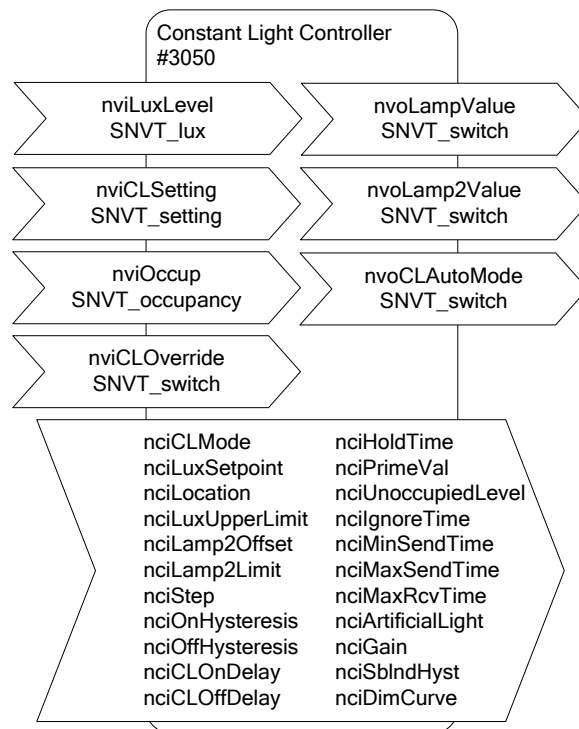

Figure 58: Constant Light Controller Object

This object type is enabled in the default interface. It can be disabled.

#### 6.1.4.1 Interaction with other LONMARK Objects

To minimize the number of bindings that have to be created the constant light controller uses default connections to the local light sensor, occupancy sensor, and group objects in case no “real” bindings are done. This function is referred to as **Automatic Internal Bindings**. Figure 59 shows these default connections of the constant light controller object. Per default the constant light controller with index X controls the group object with index X. The current lux level is received from the light sensor object with index X and the occupancy state is received from the occupancy sensor X. The default connections can be changed by creating bindings with the network management tool. A detailed description under which conditions the default connections apply is given in Table 7.

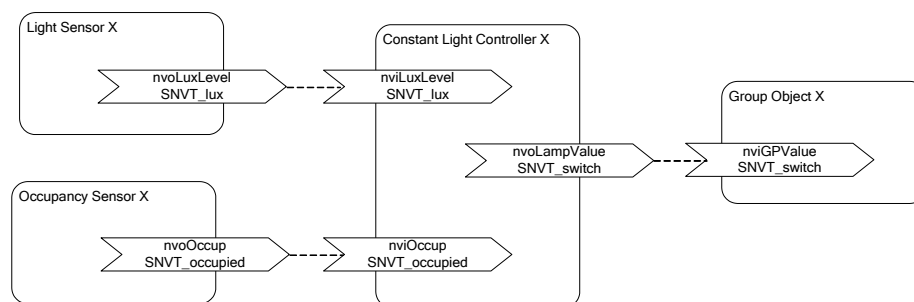

Figure 59: Default Connections to other LONMARK Objects

Per default automatic bindings are disabled. They can be enabled using the project settings in the LINX Configurator software (see LINX Configurator User Manual [2]) or the Web-Interface (see Section 6.3.1).

Default Connection	Condition
Lux Level	The default connection applies if the following network variables are not bound: <ul style="list-style-type: none"> <li>• <i>nviLuxLevel</i> (Constant Light Controller X)</li> <li>• <i>nviOccup</i> (Constant Light Controller X)</li> </ul>
Occupancy State	The default connection applies if the following network variables are not bound: <ul style="list-style-type: none"> <li>• <i>nviLuxLevel</i> (Constant Light Controller X)</li> <li>• <i>nviOccup</i> (Constant Light Controller X)</li> </ul>
Lamp Value	The default connection applies if the following network variables are not bound: <ul style="list-style-type: none"> <li>• <i>nvoLampValue</i> (Constant Light Controller X)</li> <li>• <i>nviGPValue</i> (Group Object X)</li> <li>• <i>nviGPSetting</i> (Group Object X)</li> <li>• <i>nviGPOverride</i> (Group Object X)</li> <li>• <i>nviGPScene</i> (Group Object X)</li> </ul>

Table 7: Default Connections for Automatic Internal Bindings.

When using local DALI sensors and/or DALI groups internal manual CLC bindings can be configured in the DALI Parameters tab of the LINX Configurator software (see LINX Configurator User Manual [2]) or the Web-Interface (see Section 6.3.1). The Web-Interface for CLC Bindings can also be used to verify the current status of all bindings (internal and NVs).

#### 6.1.4.2 Setpoint

The desired setpoint for the illumination level is configured via the configuration property *nciLuxSetpoint*. The input network variable *nviCLSetting* of type SNVT\_setting switches the constant light controller on or off. Furthermore this network variable can be used to temporarily adjust the setpoint.

#### 6.1.4.3 Operating Modes

The operating mode of the constant light controller is set via the configuration property *nciCLMode*. Table 8 shows the different operating modes and under which conditions they are used:

Operating Mode	Description
REGULATOR	A light sensor that measures the indoor illumination is installed. An occupancy sensor is installed.
REGULATOR_NO_OCC	A light sensor that measures the indoor illumination is installed. No occupancy sensor is installed.
REGULATOR_AUTO	Similar to REGULATOR, but a manual override is automatically relinquished when the room becomes unoccupied.
REGULATOR_BEDROOM	Similar to REGULATOR_AUTO, but a manual override is not automatically relinquished when the lights are overridden to off.
CONTROL	A light sensor that measures the outdoor illumination is installed. An occupancy sensor is installed.
CONTROL_NO_OCC	A light sensor that measures the outdoor illumination is installed. No occupancy sensor is installed.
CONTROL_AUTO	Similar to CONTROL, but a manual override is automatically relinquished when the room becomes unoccupied.
CONTROL_BEDROOM	Similar to CONTROL_AUTO, but a manual override is not automatically relinquished when the lights are overridden to off.
PRESENCE	Based on occupancy the lights shall be switched on and off.
PRESENCE_AUTO	Similar to PRESENCE, but a manual override is automatically relinquished when the room becomes unoccupied.
MANUAL_ON_AUTO_OFF	Lights are switched on manually, but shall be switched off when the room becomes unoccupied.
AMBIENT	Effect or ambient lighting is switched on based on the measured illumination level.
UPDATER	A DALI sensor with constant light controller functionality shall be mapped to the CEA-709 network. Only the setpoint shall be adjustable via the CEA-709 interface.

Table 8: Constant Light Controller Operation Modes

### Regulator Mode

The REGULATOR mode has to be selected if the installed light sensor measures the indoor brightness. The constant light controller receives the current indoor lux level via the input network variable *nviLuxLevel* and adjusts the lamp level (from 0% to 100%) by means of a fuzzy control algorithm.

When the light is switched on the control algorithm selects a lamp value which results in a lux level close to the desired setpoint and then adjusts the lamp value in increments once every second until the configured setpoint is reached. The size of increments is adjusted dynamically but will never exceed the percentage value defined in the configuration property *nciStep*.

The regulator mode is available in different flavors:

- **With our without occupancy sensor:** If an occupancy sensor is installed and the room becomes unoccupied, the current light level is saved and the light is dimmed to unoccupied level (see Section 6.1.4.8). If the room becomes occupied before the light has reached the unoccupied level, the saved light level is restored.
- **With automatic relinquish:** Any manual override will be automatically relinquished when the room becomes unoccupied. In a special bedroom mode the automatic

relinquish will only take place if the lights are on. If they were switched off manually, the controller does not return to automatic mode when the area turns unoccupied.

### Control Mode

The CONTROL mode has to be selected if the installed light sensor measures the outdoor illumination. The constant light controller receives the current outdoor lux level via the input network variable *nviLuxLevel* and sets the lamp level (from 0% to 100%) accordingly (see Figure 60).

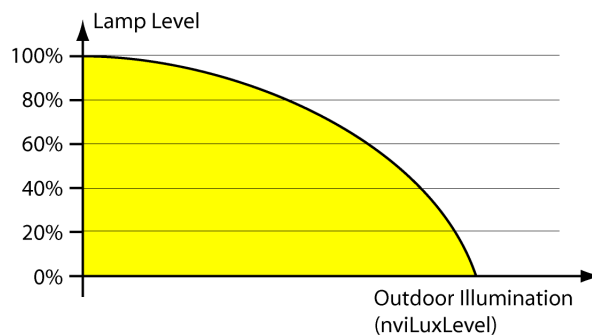

Figure 60: Control Mode

The configuration property *nciStep* ensures that the light level does not change abruptly. Per second the light level is not changed more than the percentage value defined by this configuration property. When the light is switched on or off, *nciStep* is not taken into account.

To ensure that the setpoint is reached under all weather conditions, the control curve shown Figure 60 has to be adjusted by calibrating the constant light controller. The calibration of the constant light controller is best performed with the LINX Configurator software (DALI Parameters tab, see LINX Configurator User Manual [2]).

The control mode is available in different flavors:

- **With our without occupancy sensor:** If an occupancy sensor is installed and the room becomes unoccupied, the current light level is saved and the light is dimmed to unoccupied level (see Section 6.1.4.8). If the room becomes occupied before the light has reached the unoccupied level, the saved light level is restored.
- **With automatic relinquish:** Any manual override will be automatically relinquished when the room becomes unoccupied. In a special bedroom mode the automatic relinquish will only take place if the lights are on. If they were switched off manually, the controller does not return to automatic mode when the area turns unoccupied.

### Presence Mode

The PRESENCE mode has to be if the constant light controller shall operate as occupancy controller. In this mode the light is switched to the value *nciPrimeVal* if the room is occupied and to the unoccupied level (see Section 6.1.4.8) once the room becomes unoccupied.

If the network variable input *nviLuxLevel* is bound, the light is switched to the value *nciPrimeVal* only if the lux level is below *nciLuxSetpoint* and the room is occupied.

The presence mode is available in different flavors:

- **With or without automatic relinquish:** If automatic relinquish is active any manual override will be automatically relinquished when the room becomes unoccupied.

### Manual-On/Auto-Off Mode

The MANUAL\_ON\_AUTO\_OFF mode is a variation of the PRESENCE mode. However, in this mode the constant light controller does not switch on the lights, when the room becomes occupied. Rather, it switches the lights to the unoccupied level (see Section 6.1.4.8) when the room becomes unoccupied, using *nciHoldTime* similar to PRESENCE mode.

Lights can be switched on (or off) using *nviCLOverride* or *nviCLSetting* or via some other DALI master (e.g. a DALI push-button).

### Ambient Mode

The AMBIENT mode is used if effect lighting (e.g. lights in a shop window, facade lighting, floor lights etc.) has to be switched on or off depending on a measured light level. Lights are switched to the value *nciPrimeVal* when the *nviLuxLevel* is below *nciLuxSetpoint* and to the unoccupied level (see Section 6.1.4.8) when *nviLuxLevel* is higher than *nciLuxSetpoint*.

### Updater Mode

The UPDATER mode has to be selected when a DALI light/occupancy sensor with constant light controller functionality is installed on the DALI network. In this mode no light level computation is performed. The controller simply forwards the parameters to the DALI constant light controller and retrieves lamp setting from the DALI light sensor.

In general, LOYTEC does not recommend using UPDATER mode. Wherever possible use REGULATOR or CONTROL mode instead and use DALI sensors only as lux level and occupancy information source via the corresponding sensor objects. These modes allow improved influence of the constant light controller's parameters via the fieldbus side.

## 6.1.4.4 Prioritized Control

The network variable input *nviCLOverride* can be used to override the constant light controller algorithm. Valid (*.state=0/1*) values received on this inputs are directly passed to the *nvoLampValue* output.

Similar an override is possible via the network variable input *nviCLSetting* when setting the *.function* field to SET\_OFF or to SET\_STATE. When using SET\_STATE the value of the *.setting* field is directly passed to the *nvoLampValue* output.

When internal CLC bindings are used to control DALI groups an override can also be performed using a DALI push-button device controlling the same groups as the constant light controller (see Section 6.1.4.9) or with a scene recall on those groups.

To return to automatic mode the following options exist:

- Set the *.state* field of *nviCLOverride* to -1 (invalid).
- Set the *.function* field of *nviCLSetting* to SET\_ON.
- Recalling the scene 255 on the lamp actuator object of a group linked to the constant light controller (see Section 6.1.1.1).
- Using the button function AUTO of a DALI push-button (e.g. LDALI-BM1) with the destination set to one of the constant light controllers groups (see Section 6.1.4.9).



- When using one of the modes with automatic override relinquish (xxx\_AUTO or xxx\_BEDROOM) the constant light controller will return to automatic mode when it changes its state to unoccupied.

Whether the constant light controller is in automatic mode or in manual/override mode is reflected by the network variable output *nvoCLAutoMode*.

#### 6.1.4.5 Controlling Multiple Light Bands

The L-DALI constant light controller allows controlling two light bands (groups). The primary light band is near the inside of the building, the secondary light band is near the window front. Depending on the outdoor light intensity the primary light band has to be brighter than the secondary light band to illuminate the room evenly.

The primary light band is controlled by the output network variable *nvoLampValue*, the secondary light band by the output network variable *nvoLamp2Value*. Further for both light bands internal bindings to local DALI groups and their corresponding Group Actuator objects can be configured in the DALI Parameters tab of the LINX Configurator software (see LINX Configurator User Manual [2]) or the Web-Interface (see Section 6.3.1).

The maximum difference between the two light bands can be configured via the configuration property *nciLamp2Offset* as shown in Figure 61. The configuration property *nciLamp2Limit* defines the light level above which the values of *nvoLampValue* and *nvoLamp2Value* are identical.

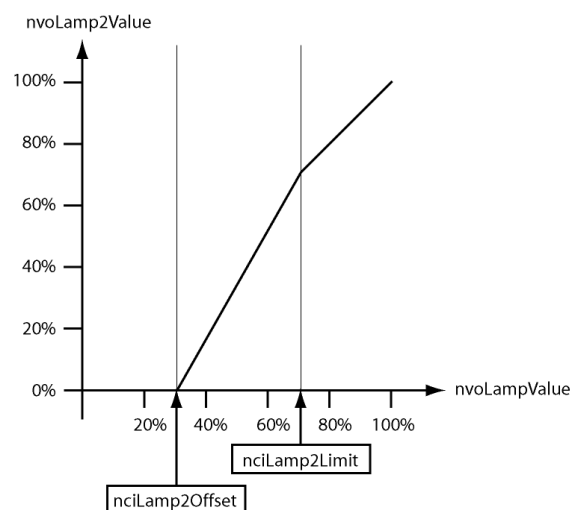

Figure 61: Secondary Light Band

#### 6.1.4.6 Occupancy Detection

The constant light controller receives the occupancy information via the network variable input *nviOccup*.

If a hold time is configured (*nciHoldTime* > 0) occupancy evaluation is event based. That is, the constant light controller changes to the occupied state when the value OC\_OCCUPIED is received. When the OC\_UNOCCUPIED value is received the constant light controller remains in the occupied state until the hold time configured in *nciHoldTime* has expired and then changes to the unoccupied state. Further, if no OC\_OCCUPIED is received for the time configured in *nciHoldTime* the constant light controller changes to the unoccupied state, too.

This behavior typically requires the occupancy sensor to send OC\_OCCUPIED with a regular interval (heartbeat). It allows using multiple occupancy sensors with the same constant light controller (fan-in).

If no hold time is configured ( $nciHoldTime = 0$ ) occupancy evaluation is state based. That is, the constant light controller changes to the occupied state when the value OC\_OCCUPIED is received and to unoccupied state when the value OC\_UNOCCUPIED is received.

This behavior is typically required if the occupancy information is only propagated if the state changes (no heartbeat functionality). It does not allow using multiple occupancy (fan-in) sensors without additional logic (e.g. an Occupancy Controller).

After the light has been switched off any updates on the  $nviOccup$  input are ignored for the time specified in  $nciIgnoreTime$ .

The current occupancy state calculated by the constant light controller is available via the network variable  $nvoCLOccupancyState$ .

---

*Note:* The network variable  $nvoCLOccupancyState$  is not part of the standard interface. It must be enabled in the CEA-709 project settings (see LINX Configurator User Manual [2]).

---

#### 6.1.4.7 Timing Parameters

To avoid that the constant light controller switches the light on and off repeatedly if the measured lux value is near the setpoint, a hysteresis can be configured. The configuration parameter  $nciOffHysteresis$  defines the hysteresis for switching off the lamp and the configuration property  $nciOnHysteresis$  defines the hysteresis for switching on the lamp. In addition a delay can be configured before the lamp is switched on ( $nciCLOnDelay$ ) or off ( $nciCLOffDelay$ ). Figure 62 illustrates these configuration parameters.

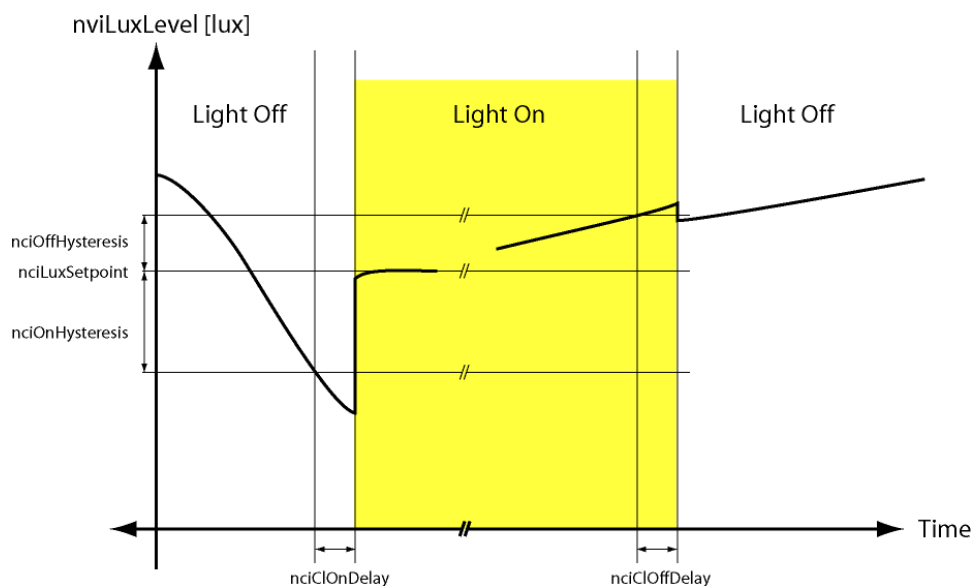

Figure 62: Constant Light Controller Timing

#### 6.1.4.8 Unoccupied Level

If the constant light controller enters unoccupied state (see Section 6.1.4.6)  $nciUnoccupiedLevel$  and  $nciCLOffDelay$  determine the behavior as shown in Table 9.

<i>nciUnoccupiedLevel</i>	<i>nciCLOffDelay</i>	<b>Behavior</b>
0	0	Dim down and switch off lights
> 0	0	Dim down lights to value defined in <i>nciUnoccupiedLevel</i> .
0	> 0	Dim down to 0.5% and switch off lights after <i>nciCLOffDelay</i> .
> 0	> 0	Dim down lights to value defined in <i>nciUnoccupiedLevel</i> and switch off lights after <i>nciCLOffDelay</i> .

Table 9: Behavior of constant light controller when entering unoccupied state.

#### 6.1.4.9 Interaction with DALI Buttons

When internal CLC bindings are used to control DALI groups an override can also be performed using a DALI push-button device like the LDALI-BM1 (or some other DALI master) controlling the same groups as the constant light controller.

Whenever the light level of one of the ballasts controlled by the constant light controller is changed by operating a DALI button the constant light controller will detect this and stop controlling the group and enter override mode. Furthermore, the *nviCLOverride* and the *nvoLampValue* and *nvoLamp2Value* will be updated with the new feedback value of the group controlled by the DALI button. See Section 6.1.4.4 on how to relinquish the override and return to automatic operation.

See the LOYTEC Device User Manual [1] on how to configure DALI button functions via the web interface and the LINX Configurator User Manual [2] how to configure them via the DALI Parameters tab of the LINX Configurator software.

#### 6.1.4.10 Interacting with Sunblind Controller

One or more local sunblind controller objects can be linked to a constant light controller object. Typically sunblind controllers are linked to the constant light controller of the same room. If they change the sunblind's position or rotation the sunblind controllers inform the linked constant light controller. The constant light controller uses this information to "ignore" temporary changes of the rooms illumination levels due to the moving sunblinds and, thus, can avoid to switch on lights unnecessarily.

#### 6.1.4.11 Museum Mode

The museum mode is activated by setting an upper limit for the lux level in the room using the configuration property *nciLuxUpperLimit*. In museum mode the constant light controller cooperates with the linked sunblind controllers to ensure that the measured lux level stays between *nciLuxSetpoint* and *nciLuxUpperLimit*. Therefore at least one sunblind controller has to be linked to the constant light controller.

If the light intensity in the room needs to be increased to reach the lower setpoint (*nciLuxSetpoint*) there are two possibilities: Increase the lamp level or open the sunblinds. The configuration property *nciSblndHyst* defines how much the lamp level is increased or decreased before opening or closing the sunblinds respectively.

#### 6.1.4.12 Set-Up Checklist

To get a working constant light controller object at least the following configuration steps have to be performed:

1. Bindings: If the constant light controller is not operated with its default auto-bindings (see Section 6.1.4.1) at least the following NVs have to be bound:

- `nviOccup`
- `nviLuxLevel`
- `nvoLampValue`

Alternatively internal manual bindings can be configured in the DALI Parameters tab of the LINX Configurator software (see LINX Configurator User Manual [2]) or the Web-Interface (see Section 6.3.1). The Web-Interface for CLC Bindings can be used to verify the current status of all bindings (internal and NVs).

2. Mode: The operating mode of the constant light controller has to be configured using `nciCLMode` (see Section 6.1.4.3).
3. Disable override: Ensure no override is active via the NV `nviCLOverride` (see Section 6.1.4.4).

### 6.1.4.13 Input Network Variables

<b>nviLuxLevel</b>	
<b>Type</b>	SNVT_lux
<b>Valid Range</b>	0..65,335 lux
<b>Default Value</b>	-
<b>Description</b>	This network variable input provides the illumination level measured by the light sensor. If the variable is not bound, the <code>nvoLuxLevel</code> output of the light sensor object with the same instance number as the constant light controller is used.

nviCLSetting											
<b>Type</b>	SNVT_setting										
<b>Valid Range</b>	.function: SET_OFF (0):     Override to off. SET_ON (1)     Enable/Relinquish override. SET_DOWN (2)   Decrease setpoint by specified value. SET_UP (3)     Increase setpoint by specified value. SET_STATE (5)   Override to specified value. .setting: 0..100, resolution 0.5 .rotation: not used										
<b>Default Value</b>											
<b>Description</b>	<p>This network variable input is used to enable (SET_ON) or disable (SET_OFF) the controller, to adjust the set point of the constant light controller (SET_UP and SET_DOWN) or to manually update the <i>nvoLampValue</i> and the <i>nvoLamp2Value</i> (SET_STATE).</p> <table border="1"> <thead> <tr> <th>Function</th> <th>Description</th> </tr> </thead> <tbody> <tr> <td>SET_OFF</td> <td>Deactivates the constant light controller and switches off the lamp value outputs <i>nvoLampValue</i> and <i>nvoLamp2Value</i>.</td> </tr> <tr> <td>SET_ON</td> <td>Activates the constant light controller. Relinquishes any override.</td> </tr> <tr> <td>SET_UP, SET_DOWN</td> <td>The set point of the controller can be increased (SET_UP) or decreased (SET_DOWN) temporarily. The <i>.setting</i> value is used to define the relative size of the increment/decrement. The changes made to the set point are not stored permanently into the memory. The next SET_ON command restored the original set point value (<i>nciLuxSetpoint</i>).</td> </tr> <tr> <td>SET_STATE</td> <td>Deactivates the constant light controller and sets <i>nvoLampValue</i> and <i>nvoLamp2Value</i> to the value specified in the <i>.setting</i> field (see Section 6.1.4.4). <i>nciLamp2Offset</i> and <i>nciLamp2Limit</i> are not considered.</td> </tr> </tbody> </table>	Function	Description	SET_OFF	Deactivates the constant light controller and switches off the lamp value outputs <i>nvoLampValue</i> and <i>nvoLamp2Value</i> .	SET_ON	Activates the constant light controller. Relinquishes any override.	SET_UP, SET_DOWN	The set point of the controller can be increased (SET_UP) or decreased (SET_DOWN) temporarily. The <i>.setting</i> value is used to define the relative size of the increment/decrement. The changes made to the set point are not stored permanently into the memory. The next SET_ON command restored the original set point value ( <i>nciLuxSetpoint</i> ).	SET_STATE	Deactivates the constant light controller and sets <i>nvoLampValue</i> and <i>nvoLamp2Value</i> to the value specified in the <i>.setting</i> field (see Section 6.1.4.4). <i>nciLamp2Offset</i> and <i>nciLamp2Limit</i> are not considered.
Function	Description										
SET_OFF	Deactivates the constant light controller and switches off the lamp value outputs <i>nvoLampValue</i> and <i>nvoLamp2Value</i> .										
SET_ON	Activates the constant light controller. Relinquishes any override.										
SET_UP, SET_DOWN	The set point of the controller can be increased (SET_UP) or decreased (SET_DOWN) temporarily. The <i>.setting</i> value is used to define the relative size of the increment/decrement. The changes made to the set point are not stored permanently into the memory. The next SET_ON command restored the original set point value ( <i>nciLuxSetpoint</i> ).										
SET_STATE	Deactivates the constant light controller and sets <i>nvoLampValue</i> and <i>nvoLamp2Value</i> to the value specified in the <i>.setting</i> field (see Section 6.1.4.4). <i>nciLamp2Offset</i> and <i>nciLamp2Limit</i> are not considered.										

nviOccup	
<b>Type</b>	SNVT_occupancy
<b>Valid Range</b>	OC_NUL (-1):       Invalid Value OC_OCCUPIED (0):   Area is occupied OC_UNOCCUPIED (1): Area is unoccupied OC_BYPASS (2):     Ignored OC_STANDBY (3):    Ignored
<b>Default Value</b>	OC_NUL
<b>Description</b>	<p>This network variable input provides the occupancy state measured by the occupancy sensor.</p> <p>If the variable is not bound, the <i>nvoOccup</i> output of the occupancy sensor object with the same instance number as the constant light controller is used.</p>

<b>nviCLOverride</b>	
<b>Type</b>	SNVT_switch
<b>Valid Range</b>	.value: 0..100% .state: 0, 1, -1 On: .state=1 and .value>0 Off: .state=0 and .value=0 Invalid: .state=-1
<b>Default Value</b>	
<b>Description</b>	This network variable input can be used to manually override the constant light controller (see Section 6.1.4.4). If a valid value is received (.state = 0/1), the constant light controller is disabled and <i>nvoLampValue</i> and <i>nvoLamp2Value</i> are set to the specified value. <i>nciLamp2Offset</i> and <i>nciLamp2Limit</i> are not considered. If an invalid value (.state -1) is received, the constant light controller returns to automatic mode. When performing an override via a DALI button the network variable will reflect the resulting feedback value of the group controlled by the DALI button (see Section 6.1.4.9).

#### 6.1.4.14 Output Network Variables

<b>nvoLampValue</b>	
<b>Type</b>	SNVT_switch
<b>Valid Range</b>	.value: 0..100% .state: 0, 1, -1 On: .state=1 and .value>0 Off: .state=0 and .value=0 Invalid: .state=-1
<b>Default Value</b>	
<b>Description</b>	This network variable outputs provides the state (ON or OFF), and the percentage level of intensity for a lamp actuator. If the variable is not bound, the value is transmitted to the <i>nviGPValue</i> input of the DALI group object with the same instance number as the constant light controller.

<b>nvoLamp2Value</b>	
<b>Type</b>	SNVT_switch
<b>Valid Range</b>	.value: 0..100% .state: 0, 1, -1 On: .state=1 and .value>0 Off: .state=0 and .value=0 Invalid: .state=-1
<b>Default Value</b>	
<b>Description</b>	This network variable provides the state (ON or OFF), and the percentage level of intensity for the secondary light band. The value for the secondary light band ( <i>nvoLamp2Value</i> ) is set according to the configuration properties <i>nciLamp2Offset</i> and <i>nciLamp2Limit</i> .

nvoCLAutoMode	
<b>Type</b>	SNVT_switch
<b>Valid Range</b>	On: .state=1 and .value=100 Off: .state=0 and .value=0
<b>Default Value</b>	
<b>Description</b>	This network variable output provides the current state of the constant light controller.  Off: The constant light controller is disabled or overridden by <i>nviCLOverride</i> or the DALI Mode button/LCD UI.  On: The constant light controller is enabled and not overridden by <i>nviCLOverride</i> or the DALI Mode button/LCD UI.

nvoCLOccupState	
<b>Type</b>	SNVT_occupancy
<b>Valid Range</b>	OC_NUL (-1): Invalid Value OC_OCCUPIED (0): Area is occupied OC_UNOCCUPIED (1): Area is unoccupied
<b>Default Value</b>	
<b>Description</b>	This network variable output provides the current occupancy state calculated by the constant light controller (see Section 6.1.4.6).  <i>Note: This network variable is not part of the standard interface. It must be enabled in the CEA-709 project settings (see LINX Configurator User Manual [2]).</i>

#### 6.1.4.15 Configuration Properties

All configuration properties listed in this section are implemented as Configuration Parameters using configuration files (CPT, CPV, and CPC files). File access is provided via LONMARK FTP.

nciLocation	
<b>Type</b>	SCPTLocation (SNVT_str_asc)
<b>Valid Range</b>	31 ASCII characters
<b>Default Value</b>	Light Controller X
<b>Description</b>	This configuration property can be used to specify the name of the constant light controller

nciLuxSetpoint	
<b>Type</b>	SCPTluxSetpoint (SNVT_lux)
<b>Valid Range</b>	0..65,335 lux
<b>Default Value</b>	500 lux
<b>Description</b>	Defines the illumination level setpoint.

<b>nciCLMode</b>																													
<b>Type</b>	UCPTclMode (byte)																												
<b>Valid Range</b>	CL_MODE_DISABLED CL_MODE_REGULATOR CL_MODE_CONTROL CL_MODE_UPDATER CL_MODE_PRESENCE CL_MODE_REGULATOR_NO_OCC CL_MODE_CONTROL_NO_OCC CL_MANUAL_ON_AUTO_OFF CL_MODE_REGULATOR_AUTO CL_MODE_CONTROL_AUTO CL_MODE_PRESENCE_AUTO CL_MODE_AMBIENT CL_MODE_REGULATOR_BEDROOM CL_MODE_PRESENCE_BEDROOM																												
<b>Default Value</b>	CL_MODE_DISABLED																												
<b>Description</b>	<p>This configuration property defines the operating mode of the constant light controller.</p> <table border="1"> <thead> <tr> <th><b>Operating Mode</b></th> <th><b>Description</b></th> </tr> </thead> <tbody> <tr> <td>REGULATOR</td> <td>A light sensor that measures the indoor illumination is installed. An occupancy sensor is installed.</td> </tr> <tr> <td>REGULATOR_NO_OCC</td> <td>A light sensor that measures the indoor illumination is installed. No occupancy sensor is installed.</td> </tr> <tr> <td>REGULATOR_AUTO</td> <td>Similar to REGULATOR, but a manual override is automatically relinquished when the room becomes unoccupied.</td> </tr> <tr> <td>REGULATOR_BEDROOM</td> <td>Similar to REGULATOR_AUTO, but a manual override is not automatically relinquished when the lights are overridden to off.</td> </tr> <tr> <td>CONTROL</td> <td>A light sensor that measures the outdoor illumination is installed. An occupancy sensor is installed.</td> </tr> <tr> <td>CONTROL_NO_OCC</td> <td>A light sensor that measures the outdoor illumination is installed. No occupancy sensor is installed.</td> </tr> <tr> <td>CONTROL_AUTO</td> <td>Similar to CONTROL, but a manual override is automatically relinquished when the room becomes unoccupied.</td> </tr> <tr> <td>CONTROL_BEDROOM</td> <td>Similar to CONTROL_AUTO, but a manual override is not automatically relinquished when the lights are overridden to off.</td> </tr> <tr> <td>PRESENCE</td> <td>Based on occupancy the lights shall be switched on and off.</td> </tr> <tr> <td>PRESENCE_AUTO</td> <td>Similar to PRESENCE, but a manual override is automatically relinquished when the room becomes unoccupied.</td> </tr> <tr> <td>MANUAL_ON_AUTO_OFF</td> <td>Lights are switched on manually, but shall be switched off when the room becomes unoccupied.</td> </tr> <tr> <td>AMBIENT</td> <td>Effect or ambient lighting is switched on based on the measured illumination level (switching on ambient lights does not influence measured illumination level).</td> </tr> <tr> <td>UPDATER</td> <td>A DALI sensor with constant light controller functionality shall be mapped to the CEA-709 network. Only the setpoint shall be adjustable via the CEA-709 interface.</td> </tr> </tbody> </table>	<b>Operating Mode</b>	<b>Description</b>	REGULATOR	A light sensor that measures the indoor illumination is installed. An occupancy sensor is installed.	REGULATOR_NO_OCC	A light sensor that measures the indoor illumination is installed. No occupancy sensor is installed.	REGULATOR_AUTO	Similar to REGULATOR, but a manual override is automatically relinquished when the room becomes unoccupied.	REGULATOR_BEDROOM	Similar to REGULATOR_AUTO, but a manual override is not automatically relinquished when the lights are overridden to off.	CONTROL	A light sensor that measures the outdoor illumination is installed. An occupancy sensor is installed.	CONTROL_NO_OCC	A light sensor that measures the outdoor illumination is installed. No occupancy sensor is installed.	CONTROL_AUTO	Similar to CONTROL, but a manual override is automatically relinquished when the room becomes unoccupied.	CONTROL_BEDROOM	Similar to CONTROL_AUTO, but a manual override is not automatically relinquished when the lights are overridden to off.	PRESENCE	Based on occupancy the lights shall be switched on and off.	PRESENCE_AUTO	Similar to PRESENCE, but a manual override is automatically relinquished when the room becomes unoccupied.	MANUAL_ON_AUTO_OFF	Lights are switched on manually, but shall be switched off when the room becomes unoccupied.	AMBIENT	Effect or ambient lighting is switched on based on the measured illumination level (switching on ambient lights does not influence measured illumination level).	UPDATER	A DALI sensor with constant light controller functionality shall be mapped to the CEA-709 network. Only the setpoint shall be adjustable via the CEA-709 interface.
<b>Operating Mode</b>	<b>Description</b>																												
REGULATOR	A light sensor that measures the indoor illumination is installed. An occupancy sensor is installed.																												
REGULATOR_NO_OCC	A light sensor that measures the indoor illumination is installed. No occupancy sensor is installed.																												
REGULATOR_AUTO	Similar to REGULATOR, but a manual override is automatically relinquished when the room becomes unoccupied.																												
REGULATOR_BEDROOM	Similar to REGULATOR_AUTO, but a manual override is not automatically relinquished when the lights are overridden to off.																												
CONTROL	A light sensor that measures the outdoor illumination is installed. An occupancy sensor is installed.																												
CONTROL_NO_OCC	A light sensor that measures the outdoor illumination is installed. No occupancy sensor is installed.																												
CONTROL_AUTO	Similar to CONTROL, but a manual override is automatically relinquished when the room becomes unoccupied.																												
CONTROL_BEDROOM	Similar to CONTROL_AUTO, but a manual override is not automatically relinquished when the lights are overridden to off.																												
PRESENCE	Based on occupancy the lights shall be switched on and off.																												
PRESENCE_AUTO	Similar to PRESENCE, but a manual override is automatically relinquished when the room becomes unoccupied.																												
MANUAL_ON_AUTO_OFF	Lights are switched on manually, but shall be switched off when the room becomes unoccupied.																												
AMBIENT	Effect or ambient lighting is switched on based on the measured illumination level (switching on ambient lights does not influence measured illumination level).																												
UPDATER	A DALI sensor with constant light controller functionality shall be mapped to the CEA-709 network. Only the setpoint shall be adjustable via the CEA-709 interface.																												



nciLamp2Offset	
<b>Type</b>	UCPTlampOffset (SNVT_lev_cont)
<b>Valid Range</b>	0..100% Resolution: 0.5
<b>Default Value</b>	30%
<b>Description</b>	This configuration property defines the maximum offset between the output for the primary light band ( <i>nvoLampValue</i> ) and the secondary light band ( <i>nvoLamp2Value</i> ).

nciLamp2Limit	
<b>Type</b>	UCPTlampLimit (SNVT_lev_cont)
<b>Valid Range</b>	0..100% Resolution: 0.5
<b>Default Value</b>	70%
<b>Description</b>	This configuration property specifies the dim level at which the output for the secondary light band ( <i>nvoLamp2Value</i> ) becomes identical to the primary output ( <i>nvoLampValue</i> ).

nciStep	
<b>Type</b>	SCPTstep (SNVT_lev_cont)
<b>Valid Range</b>	0..100% Resolution: 0.5
<b>Default Value</b>	3%
<b>Description</b>	This configuration property defines the maximum step size that the constant light controller will take to approach the target illumination. Per second the light level is not changed more than the percentage value defined by this configuration property.

nciOnHysteresis	
<b>Type</b>	UCPTonHysteresis (SNVT_lev_cont)
<b>Valid Range</b>	0..100% Resolution: 0.5
<b>Default Value</b>	5%
<b>Description</b>	This configuration property defines the hysteresis for the input lux level as percentage of the setpoint for switching ON the lamp.

nciOffHysteresis	
<b>Type</b>	UCPToffHysteresis (SNVT_lev_cont)
<b>Valid Range</b>	0..100% Resolution: 0.5
<b>Default Value</b>	5%
<b>Description</b>	This configuration property defines the hysteresis for the input lux level as percentage of the setpoint for switching OFF the lamp.

nciMinSendTime	
<b>Type</b>	SCPTminSendTime (SNVT_time_sec)
<b>Valid Range</b>	0..6553.4 sec Resolution: 0.1 sec
<b>Default Value</b>	0.0 sec (disabled)
<b>Description</b>	Minimum time between updates of the <i>nvoLampValue</i> and <i>nvoLamp2Value</i> outputs.

nciMaxSendTime	
<b>Type</b>	SCPTmaxSendTime (SNVT_time_sec)
<b>Valid Range</b>	0..6553.4 sec Resolution: 0.1 sec
<b>Default Value</b>	300.0 sec
<b>Description</b>	Maximum time between updates of the <i>nvoLampValue</i> and <i>nvoLamp2Value</i> outputs (heartbeat functionality).

nciMaxRcvTime	
<b>Type</b>	SCPTmaxRcvTime (SNVT_time_sec)
<b>Valid Range</b>	0..6553.4 sec Resolution: 0.1 sec
<b>Default Value</b>	0.0 sec (disabled)
<b>Description</b>	This configuration property specifies the expected update interval of the <i>nviLuxLevel</i> network variable input. If the time elapses without an update of the variable an alarm is generated.  If no update is received on <i>nviLuxLevel</i> for 10 intervals the <i>nvoLampValue</i> and <i>nvoLamp2Value</i> network variable outputs are set to 50%.

nciCLOffDelay	
<b>Type</b>	UCPTclOffDelay (SNVT_time_sec)
<b>Valid Range</b>	0..6553.4 sec Resolution: 0.1 sec
<b>Default Value</b>	300.0 sec
<b>Description</b>	This configuration property specifies the delay after which the lamp value output ( <i>nvoLampValue</i> / <i>nvoLamp2Value</i> ) is switched off.

nciCLOnDelay	
<b>Type</b>	UCPTclOnDelay (SNVT_time_sec)
<b>Valid Range</b>	0..6553.4 sec Resolution: 0.1 sec
<b>Default Value</b>	0.0 sec
<b>Description</b>	This configuration property specifies the delay after which the lamp value output ( <i>nvoLampValue</i> / <i>nvoLamp2Value</i> ) is switched on.

<b>nciArtificialLight</b>	
<b>Type</b>	UCPTartificialLight (SNVT_muldiv)
<b>Valid Range</b>	.multiplier: 0..65,335 lux .divisor: 0..65,335 lux
<b>Default Value</b>	-
<b>Description</b>	<p>This configuration property is used if the light sensor has a different sensibility for artificial light then for natural light.</p> <p>To configure the artificial light factor do the following:</p> <ul style="list-style-type: none"> <li>• Darken the room and set the lamp to the maximum value. Measure the lux value on the reference area with a luxmeter and with the light sensor. Then switch off the lamps and measure the lux value again with a luxmeter and the light sensor.</li> <li>• Enter the difference of the lux measured by the luxmeter in <i>.multiplier</i> and the lux value difference measured by the light sensor in <i>.divisor</i>.</li> </ul> <p>The value can be reset by setting the value to its invalid value (all 0xFF).</p>

<b>nciGain</b>	
<b>Type</b>	SCPTgain (SNVT_muldiv)
<b>Valid Range</b>	.multiplier: 0..65,335 lux .divisor: 0..65,335 lux
<b>Default Value</b>	1/1
<b>Description</b>	<p>This configuration property is used to calibrate the light sensor. The configuration property is only needed if the light sensor does not have its own way of calibration. To calibrate the light sensor enter the lux value measured by a luxmeter in <i>.multiplier</i> and the lux value of the light sensor in <i>.divisor</i>. The lux level should be near the setpoint for best results.</p> <p>The value can be reset by setting the value to its invalid value (all 0xFF).</p>

nciDimCurve	
<b>Type</b>	UCPTdimmingCurve
<b>Valid Range</b>	.used: 0, 1 .level_0: 0..100%, Resolution: 0.5 .level_1: 0..100%, Resolution: 0.5 .level_2: 0..100%, Resolution: 0.5 .level_3: 0..100%, Resolution: 0.5 .level_4: 0..100%, Resolution: 0.5 .level_5: 0..100%, Resolution: 0.5 .level_6: 0..100%, Resolution: 0.5 .level_7: 0..100%, Resolution: 0.5 .level_8: 0..100%, Resolution: 0.5 .level_9: 0..100%, Resolution: 0.5 .level_10: 0..100%, Resolution: 0.5
<b>Default Value</b>	.used = 0 .level_0 = 1% .level_1 = 1.5% .level_2 = 2.5% .level_3 = 4% .level_4 = 6.5% .level_5 = 10% .level_6 = 16% .level_7 = 25% .level_8 = 40% .level_9 = 64% .level_10 = 100%
<b>Description</b>	This configuration property permits to adjust the characteristic of the lamp for the human vision. If DALI lights are used the default values can be kept.

nciHoldTime	
<b>Type</b>	SCPTholdTime (SNVT_time_sec)
<b>Valid Range</b>	0..6553.4 sec Resolution: 0.1 sec
<b>Default Value</b>	600.0 sec
<b>Description</b>	This configuration property defines the hold time for the occupied state. When the OC_OCCUPIED value is received via <i>nviOccup</i> the constant light controller remains in the occupied state until the hold time has expired and then changes to the unoccupied state. If set to 0 the unoccupied state is entered when OC_UNOCCUPIED is received.  <b>Note: Setting the <i>nciHoldTime</i> to 0 does not work when using the Echelon LonMaker Browser. As a workaround the LINX Configurator can be used to set the parameters. If used in Plug-In mode parameter values will be synced to the LNS database when downloaded to the L-DALI.</b>

nciPrimeVal	
<b>Type</b>	SNVT_switch
<b>Valid Range</b>	.value: 0..100% .state: 0, 1, -1 On: .state=1 and .value>0 Off: .state=0 and .value=0
<b>Default Value</b>	100%
<b>Description</b>	If the constant light controller operates in PRESENCE or AMBIENT mode, this configuration property defines the value adopted by <i>nvoLampValue</i> when the room is occupied.

nciUnoccupiedLevel	
<b>Type</b>	UCPTunoccupiedLevel (SNVT_lev_cont)
<b>Valid Range</b>	0..100% Resolution: 0.5
<b>Default Value</b>	0.0%
<b>Description</b>	This configuration property defines the value adopted by <i>nvoLampValue</i> when the constant light controller enters unoccupied state (see Section 6.1.4.8).

nciIgnoreTime	
<b>Type</b>	UCPTignoreTime (SNVT_time_sec)
<b>Valid Range</b>	0..6553.4 sec Resolution: 0.1 sec
<b>Default Value</b>	0.0 sec
<b>Description</b>	This configuration property defines the time during which updates on <i>nviOccup</i> are ignored after that lamp was switched off.

nciLuxUpperLimit	
<b>Type</b>	UCPTluxUpperLimit (SNVT_lux)
<b>Valid Range</b>	0..65,335 lux
<b>Default Value</b>	0 lux
<b>Description</b>	The museum mode is activated by setting this configuration property to a value greater than 0. In museum mode the constant light controller cooperates with the sunblind controller to ensure that the measured lux level stays between <i>nciLuxSetpoint</i> and <i>nciLuxUpperLimit</i> . Therefore a sunblind controller has to be linked to the constant light controller by writing the constant light controller index to the configuration property <i>nciCINumber</i> of the sunblind controller.

nciSblndHyst	
<b>Type</b>	UCPTsunblindHysteresis (SNVT_lev_cont)
<b>Valid Range</b>	0..100% Resolution: 0.5
<b>Default Value</b>	20%
<b>Description</b>	This configuration property applies only for museum mode. It defines by which percentage the lamp dim value is increased before letting more sunlight in by opening the sunblinds.

### 6.1.5 Sunblind Controller Object #6111

The L-DALI provides 16 sunblind controller objects for each DALI channel.

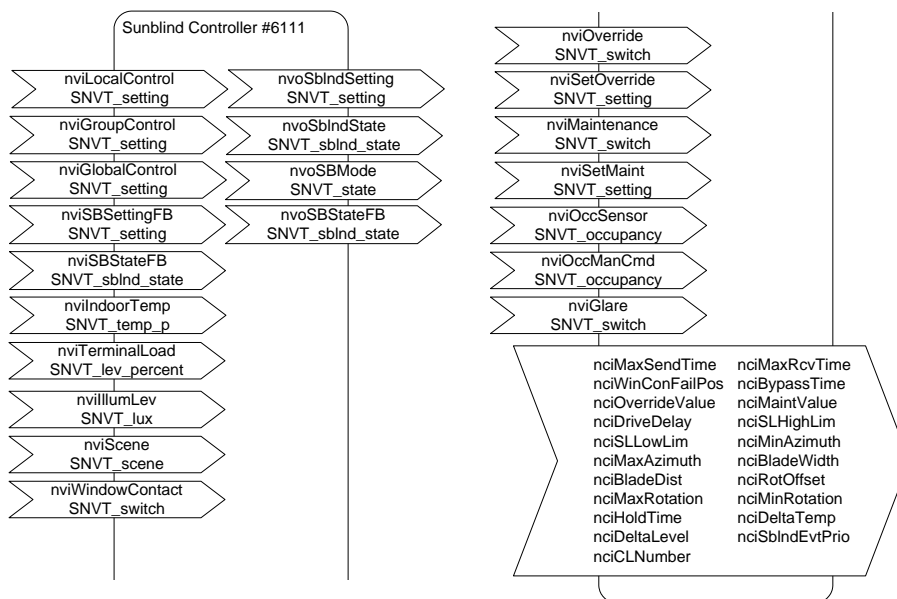

Figure 63: Sunblind Controller Object

This object type is enabled in the default interface. It can be disabled.

#### 6.1.5.1 Glare Protection

The sunblind controller can automatically control the connected sunblind actuator to provide glare protection. To do so the sunblind controller needs to know the geometry of the sunblind blades.

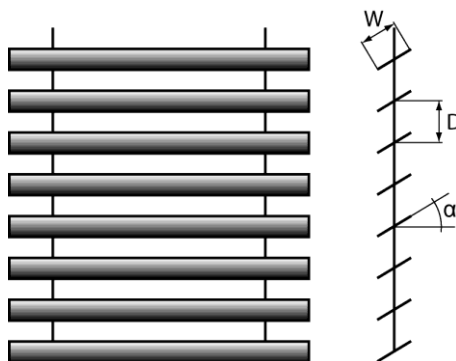

Figure 64: Sunblind Geometry

The blade distance ( $D$ ) has to be configured in the configuration property *nciBladeDist* and the blade width in *nciBladeWidth*. The minimum and maximum rotation angle ( $\alpha$ ) is configured in *nciMinRot* and *nciMaxRot*. Based on this geometry data and the current sun elevation (*nviSunElevation*) the glare protection algorithm calculates the rotation angle for the blades. The rotation angle can be optimized for a specific sunblind type by specifying an offset in the configuration property *nciRotOffset*.

The following parameters determine if glare protection is necessary:

- Sun Azimuth (*nviSunAzimuth*): Depending on the orientation of the window, the sun can only shine into the room from a certain azimuth in the morning (*nciMinAzimuth*) to a certain azimuth in the evening (*nciMaxAzimuth*).
- Outdoor lux level (*nviSunLux*): The glare protection will be activated if the measured outdoor lux level is above *nciSHiLimGlare*. If the outdoor lux level falls below *nciSLoLimGlare* the glare protection will be deactivated. These two configuration properties implement a hysteresis.
- Surrounding buildings/objects: The network variable inputs *nviGlobalGlare* and *nviGlobalShadow* can be used to provide geometry information on surrounding buildings/objects. Glare protection is active when the corresponding bit in *nviGlobalGlare* is active and the one in *nviGlobalShadow* is inactive.

Alternatively the need for glare protection can be computed by a separate device. In this case the network variable input *nviGlare* can be used to override the automatic glare detection algorithm.

### 6.1.5.2 View Protection

To protect rooms against prying eyes the sunblind can be closed automatically when the indoor light is switched on and the outdoor light level (*nviSunLux*) falls below the indoor light level (*nviIllumLev*). To avoid that the sunblind opens and closes repeatedly a hysteresis can be configured using the configuration property *nciViewProtHyst*.

### 6.1.5.3 Heating/Cooling

If the room is not occupied, the L-DALI can close the sunblind to provide thermal isolation in order to save energy.

The network variable input *nviTerminalLoad* is used to inform the controller of the current heating/cooling demand of the system. Positive values indicate that cooling energy is required, while negative values indicate that heating energy is required.

If *nviTerminalLoad* is not bound, but *nviOutdoorTemp* is bound, heating demand is assumed if the moving average outdoor temperature falls below 12°C/54°F, cooling demand is assumed if it is above 19°C/66°F.

The algorithm takes the following parameters into account:

- **Outdoor lux level (*nviSunLux*):** The energy of the sun can be used to warm a room. The configuration property *nciSHiLimTem* defines the lux level above which the sun energy will make a noticeable contribution to warm the room if the sunblind is open. The configuration property *nciSLoLimTem* define the lux level below which the sun energy is too low to warm the room. To avoid that the sunblind opens and closes repeatedly a hysteresis can be specified using the configuration property *nciTermSLHyst*.
- **Temperature:** The outdoor temperature (*nviOutdoorTemp*) is compared with the indoor temperature (*nviIndoorTemp*). Depending on whether the system is in heating or in cooling mode and on the temperature difference the sunblinds are closed to increase thermal isolation of the room. To avoid that the sunblind opens and closes repeatedly a hysteresis can be specified using the configuration property *nciTermTempHyst*.

### 6.1.5.4 Manual Control

To control the sunblind manually the L-DALI sunblind controller offers the possibilities to directly select a setpoint and to select a scene.

#### Direct Control

The sunblind can be controlled manually by the following network variable inputs of type SNVT\_setting:

- ***nviLocalControl***: Using this input network variable a local control devices can provide the setpoint for the sunblind.
- ***nviGroupControl***: Using this input network variable a control device which controls a group of sunblinds can provide the setpoint for the sunblind.
- ***nviGlobalControl***: Using this input network variable a control device which controls all sunblinds can provide the setpoint for the sunblind.

Per default *nviLocalControl* takes precedence over *nviGroupControl* which in turn takes precedence over *nviGlobalControl*. The priorities can be changes as described in Section 6.1.5.9. Local, group, and global control commands can be cancelled by setting the *function* field of the corresponding network variable to SET\_NULL.

#### Scenes

Using the input network variable *nviSBScene* of type SNVT\_scene up to 16 sunblind scenes can be saved and recalled. The command SC\_LEARN stores the current sunblind position and rotation in the specified scene number. By a SC\_RECALL command previously stored scenes can be recalled. Scenes can be deleted by a SC\_RESET command.

### 6.1.5.5 Prioritized Control

The L-DALI sunblind controller offers two methods for prioritized control: maintenance mode and override mode. Maintenance mode has the highest priority and cannot be changed. The priority of override mode can be changed as described in Section 6.1.5.9.

#### Maintenance Mode

There are two alternative ways to control the sunblind in maintenance mode:

- ***nviSetMaint***: This input network variable of type SNVT\_setting overrides the sunblind output. The maintenance mode override is canceled by setting the *function* field to SET\_NULL.
- ***nviMaintenance, nciMaintValue***: The *nviMaintenance* network variable of type SNVT\_switch can be used to switch on/off maintenance mode. If the maintenance mode is active, the sunblind output is set to the value of the configuration property *nciMaintValue* (type SNVT\_setting).

#### Override Mode

There are two alternative ways to control the sunblind in override mode:

- ***nviSetOverride***: This input network variable of type SNVT\_setting overrides the sunblind output. The override is canceled by setting the *function* field to SET\_NULL.



- ***nviSBOverride, nciOverrideValue***: The *nviSBOverride* network variable of type *SNVT\_switch* can be used to switch on/off override mode. If the override mode is active, the sunblind output is set to the value of the configuration property *nciOverrideValue* (type *SNVT\_setting*).

### 6.1.5.6 Museum Mode

For the museum mode of the constant light controller (see Section 6.1.4.11) a sunblind controller must be linked to the constant light controller.

### 6.1.5.7 Output and Feedback

The L-DALI sunblind controller supports actuators with a control input of type *SNVT\_sblnd\_state* (see Figure 65) as well as sunblind actuators with a control input of type *SNVT\_setting* (see Figure 66).

The configuration property *nciDriveDelay* defines the delay which the sunblind controller waits until it updates its outputs. If different drive delays are configured for the different sunblind controllers, the sunblinds will not drive at the same time avoiding a power peak.

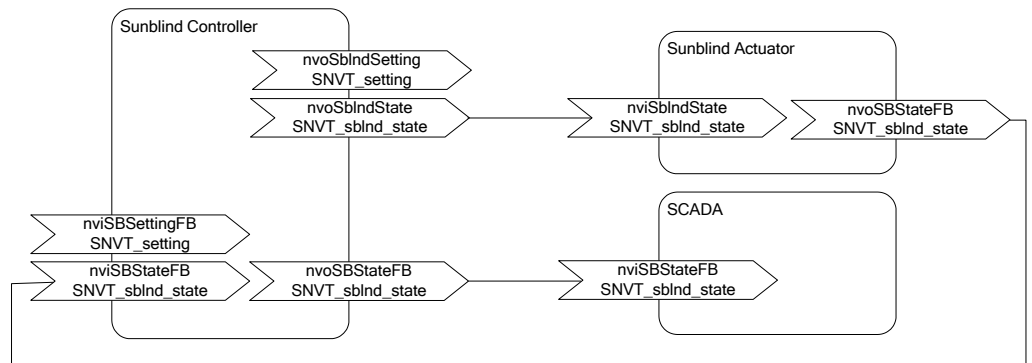

Figure 65: Controlling a Sunblind Actuator via *SNVT\_sblnd\_state*

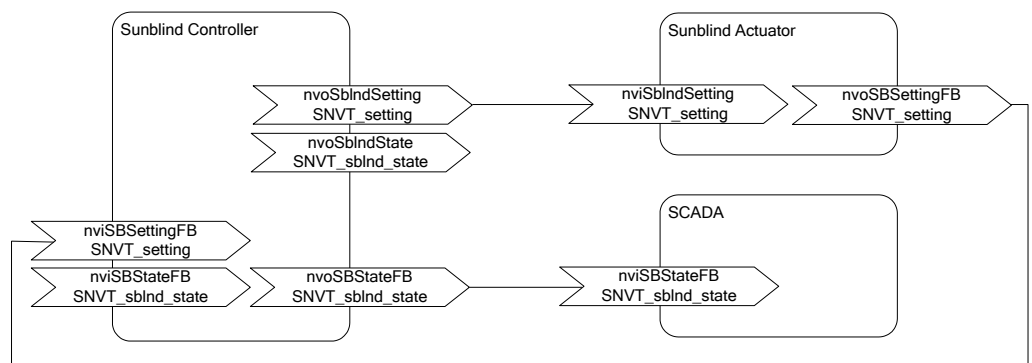

Figure 66: Controlling a Sunblind Actuator via *SNVT\_setting*

The output network variable *nvoSBStateFB* can be used by e.g. a SCADA system to display the current state of the sunblind. It includes status information from the sunblind controller, which is merged with feedback information from the sunblind actuator, if available.

The event state (e.g. maintenance mode, rain condition, wind, etc) of the sunblind controller is reported in the output network variable *nvoSBMode*.

### 6.1.5.8 Occupancy Detection

The occupied/unoccupied status of the room can be determined by an occupancy sensor and/or a manual command.

#### Occupancy Sensor

To connect an occupancy sensor the network variable input *nviOccSensor* is used. Its behavior is identical to the *nviOccup* of the Constant Light Controller object (see Section 6.1.4.6).

#### Manual Command

The network variable input *nviOccManCmd* is used to override the occupancy sensor or if no occupancy sensor is available. This network variable of type *SNVT\_occupancy* can have the following values:

- **OC\_OCCUPIED:** The sunblind controller should operate in the occupied mode.
- **OC\_UNOCCUPIED:** The sunblind controller should operate in the unoccupied mode.
- **OC\_BYPASS:** The sunblind controller should operate in the occupied mode for a period of time defined by the configuration property *nciBypassTime*.

### 6.1.5.9 Sunblind Controller Events and Priority

The operation of the sunblind controller is influenced by a number of events. Table 10 describes the different events and shows their default priority. The priority of events can be changed. Events can be deactivated by setting the priority to -1. Usually this is done on the DALI Parameters tab of the LINX Configurator (see LINX Configurator User Manual [2]).

Priority	Event	Description
18 (highest)	Set maintenance request	The network variable input <i>nviSetMaint</i> is active ( <i>function</i> not SET_NUL). See Section 6.1.5.5 for detail.
17	Maintenance request	The network variable input <i>nviMaintenance</i> is switched on. The sunblind moves to the position specified in <i>nciMaintValue</i> . See Section 6.1.5.5 for detail.
16	Weather sensor alarm*	At least one of the weather sensors failed: <ul style="list-style-type: none"> <li>• No update has been received on <i>nviWind</i> for longer than <i>nciWindRcvT</i>.</li> <li>• No update has been received on <i>nviRain</i> for longer than <i>nciRainRcvT</i>.</li> <li>• No update has been received on <i>nviFrost</i> for longer than <i>nciFrostRcvT</i>.</li> </ul> <p>The alarm condition for the wind, rain, and frost sensor is active only if the corresponding network variable input is bound.</p> <p>In case of a weather sensor alarm the sunblind drives to the position defined by <i>nciWinConFailPos</i>.</p>
15	Window sensor alarm*	Window sensor failed: No update has been received on <i>nviWindowContact</i> for longer than <i>nciMaxRcvTime</i> . This alarm is only active if the <i>nviWindowContact</i> network variable is bound. <p>In case of a window sensor alarm the sunblind drives to the position defined by <i>nciWinConFailPos</i>.</p>

Priority	Event	Description
14	Frost condition*	The sunblind controller enters the frost state if the network variable input <i>nviFrost</i> is active. When <i>nviFrost</i> becomes inactive the sunblind controller remains in the frost state for the hold time configured in <i>nciRainFroOffDly</i> . The sunblind does not move as long as the sunblind controller is in the frost state.
13	Wind*	The sunblind controller enters the wind alarm state if the measured wind speed ( <i>nviWind</i> ) exceeds the threshold configured in <i>nciWindLimit</i> . When the wind speed falls below the threshold the sunblind controller remains in the wind alarm state for the hold time configured in <i>nciWindOffDly</i> . The sunblind remains open while the sunblind controller is in the wind alarm state.
12	Rain condition*	The sunblind controller enters the rain state if the network variable input <i>nviRain</i> is active. When <i>nviRain</i> becomes inactive the sunblind controller remains in the rain state for the hold time configured in <i>nciRainFroOffDly</i> . The sunblind remains open while the sunblind controller is in the rain state.
11	Set override request	The network variable input <i>nviSetOverride</i> is active (.function !=SET_NUL). See Section 6.1.5.5 for detail.
10	Override request	The network variable input <i>nviSBOVERRIDE</i> is switched on. The sunblind drives to the position specified in <i>nciOverrideValue</i> . See Section 6.1.5.5 for detail.
9	Window open*	The window is open: The network variable input <i>nviWindowContact</i> is active. The polarity of the window contact can be changed via the configuration property <i>nciInvWinCon</i> . The sunblind does not move as long as the window is open.
8	Local control	The network variable input <i>nviLocalControl</i> is active. See Section 6.1.5.4 for detail.
7	Group control	The network variable input <i>nviGroupControl</i> is active. See Section 6.1.5.4 for detail.
6	Global control	The network variable input <i>nviGlobalControl</i> is active. See Section 6.1.5.4 for detail.
5	Scene selection	Sunblind scene recalled via network variable input <i>nviScene</i> . See Section 6.1.5.4 for detail.
4	Anti-glare*	The sunblind is controlled by the anti-glare algorithm. Only active if room is occupied. See Section 6.1.5.1 for detail.
3	View protection*	The sunblind is controlled by the view protection algorithm. Only active if room is occupied. See Section 6.1.5.2 for detail.
2	Constant light request*	The sunblind is linked to the constant light controller and is controlled by the museum mode algorithm. Only active if room is occupied. See Section 6.1.4.11 for detail.
1	Up if occupied*	The room is occupied. See Section 6.1.5.8 for detail. If the room is occupied the sunblind moves up.
0 (lowest)	Heat/cool request*	The sunblind is controlled by the heating/cooling algorithm. Only active if room is not occupied. See Section 6.1.5.3 for detail.

Table 10: Sunblind Controller Events and Priority

For events marked with \*) a minimum time can be configured via the configuration property *nciAutoEvMinTm*. These events will stay active for at least the configured time even if the event condition disappears before this time expires. In this way the sunblind controller ensures that the sunblind does not drive too frequently.

In case none of the events is active the sunblind remains in its current position.

### 6.1.5.10 Input Network Variables

<b>nviLocalControl</b>	
<b>Type</b>	SNVT_setting
<b>Valid Range</b>	.function: SET_NUL (-1): Invalid value. SET_DOWN (2) Decrease setting by specified value. SET_UP (3) Increase setting by specified value. SET_STOP (4) Stop action. SET_STATE (5) Setting on at specified value. .setting: 0..100, resolution 0.5 .rotation: -359.98 .. 360.00, resolution 0.02
<b>Default Value</b>	-
<b>Description</b>	This network variable input is used to manually control the sunblind. Usually a local control device gives this command. A local control command can be canceled by setting .function to SET_NUL.

<b>nviGroupControl</b>	
<b>Type</b>	SNVT_setting
<b>Valid Range</b>	.function: SET_NUL (-1): Invalid value SET_DOWN (2) Decrease setting by specified value SET_UP (3) Increase setting by specified value SET_STOP (4) Stop action SET_STATE (5) Setting on at specified value .setting: 0..100, resolution 0.5 .rotation: -359.98 .. 360.00, resolution 0.02
<b>Default Value</b>	-
<b>Description</b>	This network variable input is used to manually control the sunblind. Usually a device which is intended to control groups of controllers or actuators gives this command A group control command can be canceled by setting .function to SET_NUL.

<b>nviGlobalControl</b>	
<b>Type</b>	SNVT_setting
<b>Valid Range</b>	.function: SET_NUL (-1): Invalid value SET_DOWN (2) Decrease setting by specified value SET_UP (3) Increase setting by specified value SET_STOP (4) Stop action SET_STATE (5) Setting on at specified value .setting: 0..100, resolution 0.5 .rotation: -359.98 .. 360.00, resolution 0.02
<b>Default Value</b>	-
<b>Description</b>	This network variable input is used to manually control the sunblind. Usually a device which is intended to control all controllers or actuators gives this command A global control command can be canceled by setting .function to SET_NUL.

<b>nviSBSettingFB</b>	
<b>Type</b>	SNVT_setting
<b>Valid Range</b>	.function: SET_NUL (-1): Invalid value. SET_DOWN (2) Decrease setting by specified value. SET_UP (3) Increase setting by specified value. SET_STOP (4) Stop action. SET_STATE (5) Setting on at specified value. .setting: 0..100, resolution 0.5 .rotation: -359.98 .. 360.00, resolution 0.02
<b>Default Value</b>	-
<b>Description</b>	Feedback from sunblind actuator of type <i>SNVT_setting</i> .

<b>nviSBStateFB</b>	
<b>Type</b>	SNVT_sblnd_state
<b>Valid Range</b>	.pos.function: SET_NUL (-1): Invalid value. SET_DOWN (2) Decrease setting by specified value. SET_UP (3) Increase setting by specified value. SET_STOP (4) Stop action. SET_STATE (5) Setting on at specified value. .pos.setting: 0..100, resolution 0.5 .pos.rotation: -359.98 .. 360.00, resolution 0.02 .cmd_source: SBCS_NUL, SBCS_LOCAL, SBCS_GROUP, ... .error_code: SBE_NUL, SBE_NO_ERROR, SBE_IN_PROGRESS, ...
<b>Default Value</b>	-
<b>Description</b>	Feedback from sunblind actuator of type <i>SNVT_sblnd_state</i> .

<b>nviIndoorTemp</b>	
<b>Type</b>	SNVT_temp_p
<b>Valid Range</b>	-273.17°C...327.66°C Resolution: 0.01°C
<b>Default Value</b>	-
<b>Description</b>	This network variable input provides the room temperature measured by a temperature sensor. This input is used if the sunblinds are used for heating/cooling (see Section 6.1.5.3).

<b>nviTerminalLoad</b>	
<b>Type</b>	SNVT_lev_percent
<b>Valid Range</b>	-163.840..163.830 Resolution: 0.005
<b>Default Value</b>	
<b>Description</b>	This network variable input is used if the sunblinds are used for heating/cooling (see Section 6.1.5.3). The input informs the controller of the current heating/cooling demand. Positive values indicate that cooling energy is required, while negative values indicate that heating energy is required.  If the network variable is not bound, the heating/cooling feature is disabled.

nviIllumLev	
<b>Type</b>	SNVT_lux
<b>Valid Range</b>	0..65,335 lux
<b>Default Value</b>	-
<b>Description</b>	This network variable input provides the illumination level in the room. The input is used for view protection (see Section 6.1.5.2). If <i>nviIllumLev</i> is higher than the <i>nviSunLux</i> then the sunblind is closed to protect the room against prying eyes.

nviScene									
<b>Type</b>	SNVT_scene								
<b>Valid Range</b>	0..65,335 lux								
<b>Default Value</b>	.function: SC_LEARN, SC_RECALL, SC_NUL .scene_number: 1..16								
<b>Description</b>	Using this input network variable up to 16 sunblind scenes can be saved and recalled. <table border="1" data-bbox="354 824 1310 1032"> <thead> <tr> <th>Function</th> <th>Description</th> </tr> </thead> <tbody> <tr> <td>SC_LEARN</td> <td>Stores the current sunblind position and rotation in the specified scene number.</td> </tr> <tr> <td>SC_RECALL</td> <td>Recall a previously stored scene.</td> </tr> <tr> <td>SC_RESET</td> <td>Delete a scene.</td> </tr> </tbody> </table>	Function	Description	SC_LEARN	Stores the current sunblind position and rotation in the specified scene number.	SC_RECALL	Recall a previously stored scene.	SC_RESET	Delete a scene.
Function	Description								
SC_LEARN	Stores the current sunblind position and rotation in the specified scene number.								
SC_RECALL	Recall a previously stored scene.								
SC_RESET	Delete a scene.								

nviWindowContact	
<b>Type</b>	SNVT_switch
<b>Valid Range</b>	.value: 0..100% .state: 0, 1 Open: .state=1 and .value=100 Closed: .state=0 and .value=0
<b>Default Value</b>	-
<b>Description</b>	This network variable input informs the controller if the window is open or close. If the window is open, the sunblind stops moving.

nviOverride	
<b>Type</b>	SNVT_switch
<b>Valid Range</b>	.value: 0..100% .state: 0, 1 On: .state=1 and .value>=0.5% Off: .state=0 and .value=0
<b>Default Value</b>	-
<b>Description</b>	This network variable input is used to switch on/off override mode. If override mode is activated (.state=1 and .value between 0.5% and 100%), the sunblind adopts the setting specified by <i>nciOverrideValue</i> .

<b>nviSetOverride</b>	
<b>Type</b>	SNVT_setting
<b>Valid Range</b>	.function: SET_NUL (-1): Invalid Value SET_DOWN (2) Decrease setting by specified value SET_UP (3) Increase setting by specified value SET_STOP (4) Stop action SET_STATE (5) Setting on at specified value .setting: 0..100, resolution 0.5 .rotation: -359.98 .. 360.00, resolution 0.02
<b>Default Value</b>	-
<b>Description</b>	This input network variable overrides the sunblind output. The override is canceled by setting the .function field to SET_NULL.

<b>nviMaintenance</b>	
<b>Type</b>	SNVT_switch
<b>Valid Range</b>	.value: 0..100% .state: 0, 1 On: .state=1 and .value>=0.5% Off: .state=0 and .value=0
<b>Default Value</b>	-
<b>Description</b>	This network variable input is used to switch on/off maintenance mode. If maintenance mode is activated (.state=1 and .value between 0.5% and 100%), the sunblind adopts the setting specified by <i>nciMainValue</i> .

<b>nviSetMaint</b>	
<b>Type</b>	SNVT_setting
<b>Valid Range</b>	.function: SET_NUL (-1): Invalid Value SET_DOWN (2) Decrease setting by specified value SET_UP (3) Increase setting by specified value SET_STOP (4) Stop action SET_STATE (5) Setting on at specified value .setting: 0..100, resolution 0.5 .rotation: -359.98 .. 360.00, resolution 0.02
<b>Default Value</b>	-
<b>Description</b>	This input network variable overrides the sunblind output. The override is canceled by setting the .function field to SET_NULL.

nviOccupSensor	
<b>Type</b>	SNVT_occupancy
<b>Valid Range</b>	OC_NUL (-1): Invalid Value OC_OCCUPIED (0): Area is occupied OC_UNOCCUPIED (1): Area is unoccupied OC_BYPASS (2): Ignored OC_STANDBY (3): Ignored
<b>Default Value</b>	-
<b>Description</b>	This network variable input provides the occupancy state measured by an occupancy sensor. A hold time can be configured using the configuration property <i>nciHoldTime</i> .

nviOccManCmd											
<b>Type</b>	SNVT_occupancy										
<b>Valid Range</b>	OC_NUL (-1): Invalid Value OC_OCCUPIED (0): Area is occupied OC_UNOCCUPIED (1): Area is unoccupied OC_BYPASS (2): Area is temporarily occupied for the bypass period OC_STANDBY (3): Ignored										
<b>Default Value</b>	-										
<b>Description</b>	This network variable input can be used to manually control the occupancy state. <table border="1" data-bbox="354 992 1327 1294"> <thead> <tr> <th>Value</th> <th>Description</th> </tr> </thead> <tbody> <tr> <td>OC_NUL</td> <td>This is the initial value after power-up and it remains until another value is received. It is used to indicate that this network variable input is invalid, unused or to cancel a previous command.</td> </tr> <tr> <td>OC_OCCUPIED</td> <td>The sunblind controller should operate in the occupied mode.</td> </tr> <tr> <td>OC_UNOCCUPIED</td> <td>The sunblind controller should operate in the unoccupied mode</td> </tr> <tr> <td>OC_BYPASS</td> <td>The sunblind controller should operate in the occupied mode for a period of time defined by <i>nciBypassTime</i>.</td> </tr> </tbody> </table>	Value	Description	OC_NUL	This is the initial value after power-up and it remains until another value is received. It is used to indicate that this network variable input is invalid, unused or to cancel a previous command.	OC_OCCUPIED	The sunblind controller should operate in the occupied mode.	OC_UNOCCUPIED	The sunblind controller should operate in the unoccupied mode	OC_BYPASS	The sunblind controller should operate in the occupied mode for a period of time defined by <i>nciBypassTime</i> .
Value	Description										
OC_NUL	This is the initial value after power-up and it remains until another value is received. It is used to indicate that this network variable input is invalid, unused or to cancel a previous command.										
OC_OCCUPIED	The sunblind controller should operate in the occupied mode.										
OC_UNOCCUPIED	The sunblind controller should operate in the unoccupied mode										
OC_BYPASS	The sunblind controller should operate in the occupied mode for a period of time defined by <i>nciBypassTime</i> .										

nviGlare									
<b>Type</b>	SNVT_switch								
<b>Valid Range</b>	.value: 0..100% .state: 0, 1,-1 On: .state=1 and .value>=0.5% Off: .state=0 and .value=0 Auto .state=-1								
<b>Default Value</b>	-								
<b>Description</b>	This network variable is used to override the automatic glare detection algorithm (see Section 6.1.5.1). <table border="1" data-bbox="354 1776 1327 1955"> <thead> <tr> <th>Value</th> <th>Description</th> </tr> </thead> <tbody> <tr> <td>On</td> <td>Glare condition.</td> </tr> <tr> <td>Off</td> <td>No glare condition.</td> </tr> <tr> <td>Auto</td> <td>Use automatic glare detection algorithm.</td> </tr> </tbody> </table>	Value	Description	On	Glare condition.	Off	No glare condition.	Auto	Use automatic glare detection algorithm.
Value	Description								
On	Glare condition.								
Off	No glare condition.								
Auto	Use automatic glare detection algorithm.								



## 6.1.5.11 Output Network Variables

<b>nvoSblndSetting</b>	
<b>Type</b>	SNVT_setting
<b>Valid Range</b>	.function: SET_NUL (-1): Invalid Value SET_DOWN (2) Decrease setting by specified value SET_UP (3) Increase setting by specified value SET_STOP (4) Stop action SET_STATE (5) Setting on at specified value .setting: 0..100, resolution 0.5 .rotation: -359.98 .. 360.00, resolution 0.02
<b>Default Value</b>	-
<b>Description</b>	This network variable output provides the setpoint for the sunblind actuator.

<b>nvoSblndState</b>	
<b>Type</b>	SNVT_sbldnd_state
<b>Valid Range</b>	.pos.function: SET_NUL (-1): Invalid Value SET_DOWN (2) Decrease setting by specified value SET_UP (3) Increase setting by specified value SET_STOP (4) Stop action SET_STATE (5) Setting on at specified value .pos.setting: 0..100, resolution 0.5 .pos.rotation: -359.98 .. 360.00, resolution 0.02 .cmd_source: SBCS_NUL, SBCS_LOCAL, SBCS_GROUP, ... .error_code: SBE_NUL, SBE_NO_ERROR, SBE_IN_PROGRESS, ...
<b>Default Value</b>	-
<b>Description</b>	This network variable output provides the setpoint for the sunblind actuator and reports errors and the cause of the latest change (as determined by the sunblind controller).

<b>nvoSBMode</b>	
<b>Type</b>	SNVT_state_64
<b>Valid Range</b>	.bit0: Heat/cool request .bit1: Up if occupied .bit2: Constant light request .bit3: View protection .bit4: Anti-glare .bit5: Scene selection .bit6: Global control .bit7: Group control .bit8: Local control .bit9: Window open .bit10: Override request .bit11: Set override request .bit12: Rain condition .bit13: Wind .bit14: Frost condition .bit15: Window sensor alarm .bit16: Weather sensor alarm .bit17: Maintenance request .bit18: Set maintenance request .bit19: Not used ... .bit64: Not used
<b>Default Value</b>	-
<b>Description</b>	This network variable output reports the active events of the sunblind controller (see Section 6.1.5.9).

<b>nvoSBStateFB</b>	
<b>Type</b>	SNVT_sblnd_state
<b>Valid Range</b>	.pos.function: SET_NUL (-1): Invalid Value SET_OFF (0): Setting off SET_ON (1): Setting on SET_DOWN (2): Decrease setting by specified value SET_UP (3): Increase setting by specified value SET_STOP (4): Stop action SET_STATE (5): Setting on at specified value .pos.setting: 0..100, resolution 0.5 .pos.rotation: -359.98 .. 360.00, resolution 0.02 .cmd_source: SBCS_NUL, SBCS_LOCAL, SBCS_GROUP, ... .error_code: SBE_NUL, SBE_NO_ERROR, SBE_IN_PROGRESS, ...
<b>Default Value</b>	-
<b>Description</b>	This network variable output provides a feedback to a SCADA system: <ul style="list-style-type: none"> <li>• If the sunblind actuator provides a feedback variable of type <i>SNVT_sblnd_state</i> and it is bound to <i>nviSBStateFB</i> the sunblind actuator feedback value is copied to <i>nvoSBStateFB</i>.</li> <li>• If this is not the case, but the sunblind actuator provides a feedback variable of type <i>SNVT_setting</i> and it is bound to <i>nviSBSettingFB</i> the value is copied to <i>nvoSBStateFB</i> with the <i>cmd_source</i> field copied from the <i>nvoSblndState</i>.</li> <li>• If none of the above is the case, the value of <i>nvoSblndState</i> is copied to <i>nvoSBStateFB</i>.</li> </ul>

### 6.1.5.12 Configuration Properties

All configuration properties listed in this section are implemented as Configuration Parameters using configuration files (CPT, CPV, and CPC files). File access is provided via LONMARK FTP.

nciLocation	
<b>Type</b>	SCPTLocation (SNVT_str_asc)
<b>Valid Range</b>	31 ASCII characters
<b>Default Value</b>	Sunblind Ctrl X
<b>Description</b>	This configuration property can be used to specify the name of the sunblind controller.

nciMaxSendTime	
<b>Type</b>	SCPTmaxSendTime (SNVT_time_sec)
<b>Valid Range</b>	0..6553.4 sec Resolution: 0.1 sec
<b>Default Value</b>	0 sec
<b>Description</b>	Maximum time between updates for the <i>nvoSblindSetting</i> and <i>nvoSblindState</i> outputs (heartbeat functionality).

nciMaxRcvTime	
<b>Type</b>	SCPTmaxRcvTime (SNVT_time_sec)
<b>Valid Range</b>	0..6553.4 sec Resolution: 0.1 sec
<b>Default Value</b>	0.0 sec (disabled)
<b>Description</b>	This configuration property specifies the expected update interval of the <i>nviWindowContact</i> network variable input. If the time elapses without an update of the variable an alarm is generated and the sunblind adopts the safe position defined by the <i>nciWinConFailPos</i> .

nciWinConFailPos	
<b>Type</b>	SCPTdefaultSetting (SNVT_setting)
<b>Valid Range</b>	.function: SET_NUL (-1): Invalid Value SET_DOWN (2) Decrease setting by specified value SET_UP (3) Increase setting by specified value SET_STOP (4) Stop action SET_STATE (5) Setting on at specified value .setting: 0..100, resolution 0.5 .rotation: -359.98 .. 360.00, resolution 0.02
<b>Default Value</b>	SET_STATE, 0%, 0 deg
<b>Description</b>	This configuration property defines the safety position of a sunblind when a failure of the window contact ( <i>nviWindowContact</i> ) has been detected.

nciBypassTime	
<b>Type</b>	SCPTbypassTime (SNVT_time_min)
<b>Valid Range</b>	0..65,535 minutes
<b>Default Value</b>	0
<b>Description</b>	This configuration property defines the amount of time that the sunblind controller is in bypass (occupancy) mode following a single bypass request via <i>nviOccManCmd</i> . Additional bypass requests can restart the timer. Setting this configuration property to zero disables the bypass function and no bypass takes place.

nciOverrideValue	
<b>Type</b>	SCPTdefaultSetting (SNVT_setting)
<b>Valid Range</b>	.function: SET_NUL (-1): Invalid Value SET_DOWN (2) Decrease setting by specified value SET_UP (3) Increase setting by specified value SET_STOP (4) Stop action SET_STATE (5) Setting on at specified value .setting: 0..100, resolution 0.5 .rotation: -359.98 .. 360.00, resolution 0.02
<b>Default Value</b>	SET_NUL
<b>Description</b>	This configuration property defines the override value which is adopted by the sunblind when the <i>nviOverride</i> is at ON.

nciMaintValue	
<b>Type</b>	SCPTdefaultSetting (SNVT_setting)
<b>Valid Range</b>	.function: SET_NUL (-1): Invalid Value SET_DOWN (2) Decrease setting by specified value SET_UP (3) Increase setting by specified value SET_STOP (4) Stop action SET_STATE (5) Setting on at specified value .setting: 0..100, resolution 0.5 .rotation: -359.98 .. 360.00, resolution 0.02
<b>Default Value</b>	SET_NUL
<b>Description</b>	This configuration property defines the maintenance value which is adopted by the sunblind when the <i>nviMaintenance</i> is at ON.

nciDriveDelay	
<b>Type</b>	UCPTdriveDelay (SNVT_time_sec)
<b>Valid Range</b>	0..6553.4 sec Resolution: 0.1 sec
<b>Default Value</b>	0.0 sec (no delay)
<b>Description</b>	This configuration property defines the delay which the sunblind controller waits before it updates its outputs. If different drive delays are configured for the different sunblind controllers, the sunblinds will not drive at the same time avoiding a power peak. No drive delay is applied for local control ( <i>nviLocalControl</i> ).

<b>nciSiHiLimGlare</b>	
<b>Type</b>	UCPTsunLuxHighLimit (SNVT_lux)
<b>Valid Range</b>	0..65,335 lux
<b>Default Value</b>	30000
<b>Description</b>	This configuration property defines the high limit for the sun lux level input used by the automatic glare detection algorithm (see Section 6.1.5.1)

<b>nciSiLoLimGlare</b>	
<b>Type</b>	UCPTsunLuxHighLimit (SNVT_lux)
<b>Valid Range</b>	0..65,335 lux
<b>Default Value</b>	10000
<b>Description</b>	This configuration property defines the low limit for the sun lux level input used by the automatic glare detection algorithm (see Section 6.1.5.1)

<b>nciMinAzimuth</b>	
<b>Type</b>	UCPTminAzimuth (SNVT_angle_deg)
<b>Valid Range</b>	-359.98..360.00 deg Resolution: 0.02 deg
<b>Default Value</b>	0
<b>Description</b>	This configuration property defines the minimum azimuth for the sun elevation input used by the automatic glare detection algorithm (see Section 6.1.5.1).

<b>nciMaxAzimuth</b>	
<b>Type</b>	UCPTmaxAzimuth (SNVT_angle_deg)
<b>Valid Range</b>	-359.98..360.00 deg Resolution: 0.02 deg
<b>Default Value</b>	0
<b>Description</b>	This configuration property defines the maximum azimuth for the sun elevation input used by the automatic anti-glare algorithm (see Section 6.1.5.1).

<b>nciBladeDist</b>	
<b>Type</b>	UCPTbladeDistance (SNVT_length_mil)
<b>Valid Range</b>	0 ... 6533.5 mm Resolution: 0.1 mm
<b>Default Value</b>	7 cm
<b>Description</b>	This configuration property defines the distance between sunblind blades (see Section 6.1.5.1).

nciBladeWidth	
<b>Type</b>	UCPTbladeWidth (SNVT_length_mil)
<b>Valid Range</b>	0 ... 6533.5 mm Resolution: 0.1 mm
<b>Default Value</b>	9 cm
<b>Description</b>	This configuration property defines the width of the sunblind blades (see Section 6.1.5.1).

nciRotOffset	
<b>Type</b>	UCPTrotationOffset (SNVT_angle_deg)
<b>Valid Range</b>	-359.98..360.00 deg Resolution: 0.02 deg
<b>Default Value</b>	0
<b>Description</b>	This configuration property defines the rotation offset for the glare protection algorithm (see Section 6.1.5.1).

nciMaxRot	
<b>Type</b>	UCPTmaxRotation (SNVT_angle_deg)
<b>Valid Range</b>	-359.98..360.00 deg Resolution: 0.02 deg
<b>Default Value</b>	90
<b>Description</b>	This configuration property defines the maximum rotation for the glare protection algorithm (see Section 6.1.5.1).

nciMinRot	
<b>Type</b>	UCPTminRotation (SNVT_angle_deg)
<b>Valid Range</b>	-359.98..360.00 deg Resolution: 0.02 deg
<b>Default Value</b>	0
<b>Description</b>	This configuration property defines the minimum rotation for the glare protection algorithm (see Section 6.1.5.1).

nciDeltaTemp	
<b>Type</b>	SCPTminDeltaTemp (SNVT_temp_p)
<b>Valid Range</b>	-273.17°C...327.66°C Resolution: 0.01°C
<b>Default Value</b>	1°C
<b>Description</b>	This configuration property defines the amount by which the indoor temperature ( <i>nviIndoorTemp</i> ) value must change before it can take in account.

<b>nciHoldTime</b>	
<b>Type</b>	SCPTholdTime (SNVT_time_sec)
<b>Valid Range</b>	0..6553.4 sec Resolution: 0.1 sec
<b>Default Value</b>	600 sec
<b>Description</b>	This configuration property defines the hold time for the occupied state. When the OC_OCCUPIED value is received via <i>nviOccupSensor</i> the constant light controller remains in the occupied state until the hold time has expired and then changes to the unoccupied state. If set to 0 the unoccupied state is entered when OC_UNOCCUPIED is received.

<b>nciSblndEvtPrio</b>	
<b>Type</b>	UCPTsunblindEventPriority
<b>Valid Range</b>	.heat_cool_req: -128..127 .up_if_occupied: -128..127 .constant_light_req: -128..127 .view_protect: -128..127 .glare: -128..127 .scene_sel: -128..127 .global_req: -128..127 .group_req: -128..127 .local_req: -128..127 .window: -128..127 .override_req: -128..127 .set_override_req: -128..127 .rain: -128..127 .wind: -128..127 .frost: -128..127 .window_sensor_alarm: -128..127 .weather_sensor_alarm: -128..127 .maintenance_req: -128..127 .set_maintenance_req: -128..127
<b>Default Value</b>	All 0
<b>Description</b>	This configuration property defines the priorities of sunblind events (see Section 6.1.5.9). Higher values render higher priority. If multiple events have the same priority then they are prioritized with the default priority. Events can be disabled by setting a negative value for its priority. Events <i>maintenance_req</i> and <i>set_maintenance_req</i> will always be the highest priority events. Their value is used to define which of the two events has the higher priority.

<b>nciAutoEvMinTm</b>	
<b>Type</b>	UCPTautoDelay (SNVT_time_sec)
<b>Valid Range</b>	0..6553.4 sec Resolution: 0.1 sec
<b>Default Value</b>	600 sec
<b>Description</b>	<p>Use to specify the minimum time for the following events:</p> <ul style="list-style-type: none"> <li>• Weather sensor alarm</li> <li>• Window sensor alarm</li> <li>• Frost condition</li> <li>• Wind</li> <li>• Rain condition</li> <li>• Window open</li> <li>• Anti-glare</li> <li>• View protection</li> <li>• Constant light request</li> <li>• Up if occupied</li> <li>• Heating/cooling request</li> </ul> <p>The event will stay active for at least the configured time even if the event condition disappears before this time expires. In this way the sun blind controller ensures that the sunblind does not drive too frequently.</p>

<b>nciCLNumber</b>	
<b>Type</b>	UCPTobjectIndex (SNVT_count)
<b>Valid Range</b>	0..15 0xFFFF invalid
<b>Default Value</b>	0xFFFF (no Constant Light Controller linked)
<b>Description</b>	<p>This configuration property specifies the index of the constant light controller that is linked to the sunblind controller (see Section 6.1.4.7 und 6.1.4.11).</p> <p>Object indices start with index 0.</p>

### 6.1.6 Globals #0005

The L-DALI provides one Globals object for each DALI channel. It provides global network variable inputs and configuration properties which are not specific for a certain constant light controller or sunblind controller.



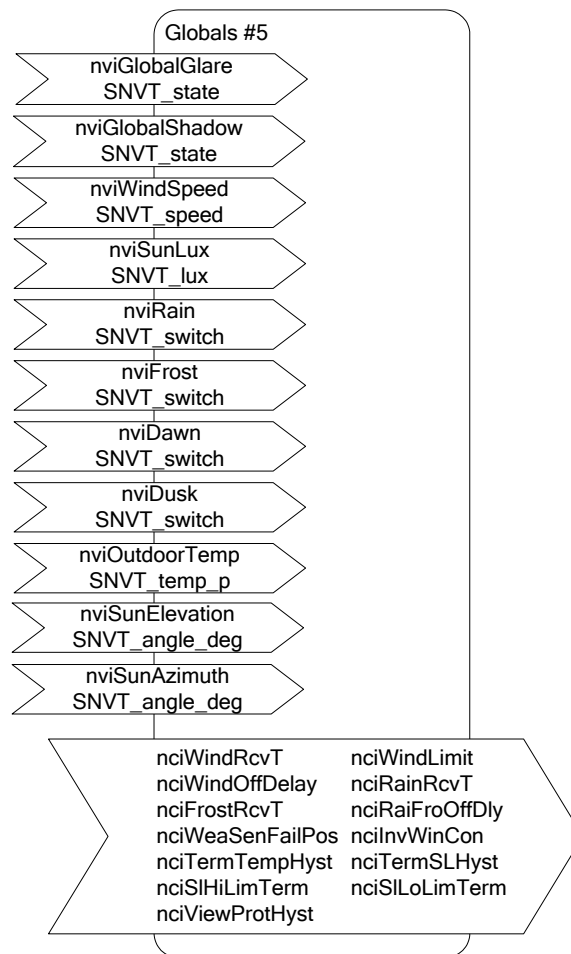

Figure 67: Global Object

This object type is enabled in the default interface. It will be disabled with the Sunblind Controller objects.

### 6.1.6.1 Network Variable Inputs

<b>nviGlobalGlare</b>	
<b>Type</b>	SNVT_state
<b>Valid Range</b>	.bit0     0, 1 ... .bit15    0, 1
<b>Default Value</b>	
<b>Description</b>	This network input permits an external calculation of glare condition for all of the 16 sunblind controllers per channel (see Section 6.1.5.1). Automatic glare protection for the sunblind controller object x is deactivated if the bit with index x is not set.

nviGlobalShadow	
<b>Type</b>	SNVT_state
<b>Valid Range</b>	.bit0 0, 1 ... .bit15 0, 1
<b>Default Value</b>	
<b>Description</b>	This network input permits an external calculation of shadow condition for all of the 16 sunblind controllers per channel (see Section 6.1.5.1). Automatic glare protection for the sunblind controller object x is deactivated if the bit with index x is set.

nviWindSpeed	
<b>Type</b>	SNVT_speed
<b>Valid Range</b>	0..6553.5 m/s Resolution: 0.1 m/s
<b>Default Value</b>	
<b>Description</b>	This network variable input provides the current wind speed measured by a wind sensor. If the wind speed is higher than the value configured in <i>nciWindLimit</i> , the sunblinds must go up.

nviSunLux	
<b>Type</b>	SNVT_lux
<b>Valid Range</b>	0..65,335 lux
<b>Default Value</b>	
<b>Description</b>	This network variable input provides the current outdoor illumination measured by a light sensor.

nviRain	
<b>Type</b>	SNVT_switch
<b>Valid Range</b>	.value: 0..100% .state: 0, 1 Rain: .state=1 and .value>=0.5% No Rain: .state=0 and .value=0
<b>Default Value</b>	
<b>Description</b>	This network variable input provides the rain status. If it is raining, the sunblinds must go up.

<b>nviFrost</b>	
<b>Type</b>	SNVT_switch
<b>Valid Range</b>	.value: 0..100% .state: 0, 1 Frost: .state=1 and .value>=0.5% No Frost: .state=0 and .value=0
<b>Default Value</b>	
<b>Description</b>	This network variable input provides the frost status. If a frost condition is detected, the sunblinds must not move.

<b>nviDawn</b>	
<b>Type</b>	SNVT_switch
<b>Valid Range</b>	.value: 0..100% .state: 0, 1 Dawn: .state=1 and .value>=0.5% No Dawn: .state=0 and .value=0
<b>Default Value</b>	
<b>Description</b>	Currently not used.

<b>nviDusk</b>	
<b>Type</b>	SNVT_switch
<b>Valid Range</b>	.value: 0..100% .state: 0, 1 Dusk: .state=1 and .value>=0.5% No Dusk: .state=0 and .value=0
<b>Default Value</b>	
<b>Description</b>	Currently not used.

<b>nviOutdoorTemp</b>	
<b>Type</b>	SNVT_temp_p
<b>Valid Range</b>	-273.17°C..327.66°C Resolution: 0.01°C
<b>Default Value</b>	
<b>Description</b>	This network variable input provides the current outdoor temperature. This input is used when the sunblinds are used to heat/cool a room (see Section 6.1.5.3).

nviSunElevation	
<b>Type</b>	SNVT_angle_deg
<b>Valid Range</b>	-359.98..360.00 deg Resolution: 0.02 deg
<b>Default Value</b>	
<b>Description</b>	This network variable input provides the current sun elevation. The elevation is the angle between the horizon and the middle of the sun, considered out of the viewpoint of an observer. The values 0 – 90° are typically used (0= Sunrise/Sunset; 90 = zenith position).

nviSunAzimuth	
<b>Type</b>	SNVT_angle_deg
<b>Valid Range</b>	-359.98..360.00 deg Resolution: 0.02 deg
<b>Default Value</b>	
<b>Description</b>	This network variable input provides the current sun azimuth. The values 0 – 359° are typically used (0 = NORTH, 90 = EAST, 180 = SOUTH, 270 = WEST).

### 6.1.6.2 Configuration Properties

All configuration properties listed in this section are implemented as Configuration Parameters using configuration files (CPT, CPV, and CPC files). File access is provided via LONMARK FTP.

nciWindRcvT	
<b>Type</b>	SCPTmaxRcvTime (SNVT_time_sec)
<b>Valid Range</b>	0..6553.4 sec Resolution: 0.1 sec
<b>Default Value</b>	0.0 sec (disabled)
<b>Description</b>	This configuration property specifies the expected update interval of the <i>nviWindspeed</i> network variable input. If the time elapses without an update of the variable an alarm is generated and the sunblinds adopt the safe position defined by <i>nciWeaSenFailPos</i> .

nciWindLimit	
<b>Type</b>	UCPTwindLimit (SNVT_time_sec)
<b>Valid Range</b>	0..6553.4 sec Resolution: 0.1 sec
<b>Default Value</b>	0.0 sec
<b>Description</b>	This configuration property defines the maximum wind for the sunblinds. If the current wind speed ( <i>nviWindspeed</i> ) is greater than the configured values the sunblinds must go up.

<b>nciWindOffDelay</b>	
<b>Type</b>	UCPTweaSenOffDelay (SNVT_time_sec)
<b>Valid Range</b>	0..6553.4 sec Resolution: 0.1 sec
<b>Default Value</b>	0.0 sec
<b>Description</b>	This configuration property defines the time for which the current wind speed ( <i>nviWindspeed</i> ) must be below the critical wind speed ( <i>nciWindLimit</i> ) before the sunblind controller return to normal operation.

<b>nciRainRcvT</b>	
<b>Type</b>	SCPTmaxRcvTime (SNVT_time_sec)
<b>Valid Range</b>	0..6553.4 sec Resolution: 0.1 sec
<b>Default Value</b>	0.0 sec (disabled)
<b>Description</b>	This configuration property specifies the expected update interval of the <i>nviRain</i> network variable input. If the time elapses without an update of the variable an alarm is generated and the sunblinds adopt the safe position defined by <i>nciWeaSenFailPos</i> .

<b>nciFrostRcvT</b>	
<b>Type</b>	SCPTmaxRcvTime (SNVT_time_sec)
<b>Valid Range</b>	0..6553.4 sec Resolution: 0.1 sec
<b>Default Value</b>	0.0 sec (disabled)
<b>Description</b>	This configuration property specifies the expected update interval of the <i>nviFrost</i> network variable input. If the time elapses without an update of the variable an alarm is generated and the sunblinds adopt the safe position defined by <i>nciWeaSenFailPos</i> .

<b>nciRaiFroOffDly</b>	
<b>Type</b>	UCPTweaSenOffDelay (SNVT_time_sec)
<b>Valid Range</b>	0..6553.4 sec Resolution: 0.1 sec
<b>Default Value</b>	0.0 sec
<b>Description</b>	This configuration property defines the time for which the rain/frost condition ( <i>nviRain/nviFrost</i> ) has to be inactive before the sunblind controller returns to normal operation.

nciWeaSenFailPos	
<b>Type</b>	SCPTdefaultSetting (SNVT_setting)
<b>Valid Range</b>	.function: SET_NUL (-1): Invalid Value SET_DOWN (2) Decrease setting by specified value SET_UP (3) Increase setting by specified value SET_STOP (4) Stop action SET_STATE (5) Setting on at specified value .setting: 0..100, resolution 0.5 .rotation: -359.98 .. 360.00, resolution 0.02
<b>Default Value</b>	SET_STATE, 0%, 0 deg
<b>Description</b>	This configuration property defines the safety position of sunblinds when a failure of a safety relevant weather sensor (e.g. <i>nviWindSpeed</i> , <i>nviRain</i> or <i>nviFrost</i> ) is detected.

nciInvWinCon	
<b>Type</b>	UCPTautoOffBreak (SNVT_lev_disc)
<b>Valid Range</b>	ST_ON, ST_OFF Inverted: ST_ON Not Inverted: ST_OFF
<b>Default Value</b>	ST_OFF (not inverted)
<b>Description</b>	This configuration property allows inverting the window contact inputs of the sunblind controllers ( <i>nviWindowContact</i> ).

nciTermTempHyst	
<b>Type</b>	SCPTtemperatureHysteresis (SNVT_temp_diff_p)
<b>Valid Range</b>	-327.68°C..327.66°C Resolution: 0.01°C
<b>Default Value</b>	1°C
<b>Description</b>	This configuration property defines the hysteresis for the outdoor temperature ( <i>nviOutdoorTemp</i> ). It is used for the heating/cooling algorithm (see Section 6.1.5.3).

nciTermSLHyst	
<b>Type</b>	UCPTterminalLoadSLhysteresis (SNVT_lev_cont)
<b>Valid Range</b>	0..100% Resolution: 0.5
<b>Default Value</b>	5.0%
<b>Description</b>	This configuration property defines the hysteresis for the sun lux level input ( <i>nviSunLux</i> ). It is used by the heating/cooling algorithm (see Section 6.1.5.3).

<b>nciSIHighLimTerm</b>	
<b>Type</b>	UCPTsunLuxHighLimit (SNVT_lux)
<b>Valid Range</b>	0..65,335 lux
<b>Default Value</b>	30000
<b>Description</b>	This configuration property defines the high limit for the sun lux level input ( <i>nviSunLux</i> ). It is used by the heating/cooling algorithm (see Section 6.1.5.3).

<b>nciSILowLimTerm</b>	
<b>Type</b>	UCPTsunLuxLowLimit (SNVT_lux)
<b>Valid Range</b>	0..65,335 lux
<b>Default Value</b>	10000 lux
<b>Description</b>	This configuration property defines the low limit for the sun lux level input ( <i>nviSunLux</i> ). It is used by the heating/cooling algorithm (see Section 6.1.5.3).

<b>nciViewProtHyst</b>	
<b>Type</b>	UCPTviewProtectionSLhysteresis (SNVT_lev_cont)
<b>Valid Range</b>	0..100% Resolution: 0.5
<b>Default Value</b>	5.0%
<b>Description</b>	This configuration property defines the hysteresis for the sun lux level input ( <i>nviSunLux</i> ). It is used by the view protection algorithm (see Section 6.1.5.2).

### 6.1.7 Button #0001

The L-DALI provides 64 button objects for each DALI channel to represent DALI buttons, switches, remote controls, panels etc. supported by the L-DALI. See the DALI Section in the LOYTEC Device User Manual [1] for supported devices.

This object type is disabled in the default interface. If required these objects must be enabled as described in the project settings (see LINX Configurator User Manual [2]). The network variables available in the button objects depend on the template selected in the project settings.

In any case the object contains the following configuration properties:

<b>nciLocation</b>	
<b>Type</b>	SCPTLocation (SNVT_str_asc)
<b>Valid Range</b>	31 ASCII characters
<b>Default Value</b>	Button X
<b>Description</b>	This configuration property can be used to specify the name of the button.

The following object templates are available:

#### 6.1.7.1 SNVT\_switch

This template has to be selected when a DALI button device allowing button function configuration is used and the state of the button has to be available on the LONMARK interface. In this case each Button object contains the following network variables:

nvoButtonState	
<b>Type</b>	SNVT_state
<b>Valid Range</b>	-
<b>Default Value</b>	0
<b>Description</b>	If a button input is configured with the button function <i>Generic</i> the state of this input is mapped to the corresponding bit of the <i>SNVT_state</i> (bit0 to input 1, bit1 to input 2, etc.). The bit is set to 1 if the button is pressed or the contact is closed and 0 otherwise.

### 6.1.7.2 Philips OccuSwitch

This template has to be selected when expanding an IRT 8080 IR-remote control the Philips OccuSwitch DALI LRM2090/20 to controlling sunblinds, fan speed, and temperature setpoint in a room. In this case each Button object contains the following network variables:

nvoSetPtOffset	
<b>Type</b>	SNVT_temp_p
<b>Valid Range</b>	-3°C to +3°C
<b>Default Value</b>	-
<b>Description</b>	This network variable output allows adjusting the HVAC setpoint by supplying an offset to a preconfigured setpoint. Its value is controlled by the temperature setpoint button on the IRT 8080.

nvoFanSpeedCmd	
<b>Type</b>	SNVT_switch
<b>Valid Range</b>	.value: 0%, 33%, 66%, 100% .state: 0, 1 On: .state = 1 and .value > 0 Off: .state = 0 and .value=any or .state=1 and .value = 0
<b>Default Value</b>	-
<b>Description</b>	This network variable output allows control the speed of a ventilation fan. Its value is controlled by the temperature fan speed button on the IRT 8080.



<b>nvoSblndControl</b>	
<b>Type</b>	SNVT_setting
<b>Valid Range</b>	.function: SET_NUL (-1): Invalid value. SET_DOWN (2) Decrease setting by specified value. SET_UP (3) Increase setting by specified value. SET_STOP (4) Stop action. SET_STATE (5) Setting on at specified value. .setting: 0..100, resolution 0.5 .rotation: -359.98 .. 360.00, resolution 0.02
<b>Default Value</b>	-
<b>Description</b>	This network variable output allows control the position and the rotation of a sunblind (via a sunblind controller or sunblind actuator object). Its value is controlled by the sunblind button on the IRT 8080.  A long press (> 1 second) of the button will set the network variable to {SET_STATE; 0,0; 65534} (up) or {SET_STATE; 100,0; 65534} (down), respectively. This allows the blinds to drive up and down.  A short press (< 1 second) while driving the blinds will set the network variable to {SET_STOP; 0,0; 0,00}. This allows stopping the blinds at the current position.  A short press (< 1 second) will set the network variable to {SET_UP; 127,5; 15} (up) or {SET_DOWN; 127,5; 15} (down), respectively. This allows rotating the blades of the sunblinds (open/close).

## 6.2 BACnet Interface and Application (LDALI-20X only)

Similar to the CEA-709 interface, the BACnet interface allows controlling DALI ballasts and access information from DALI ballasts and sensors via BACnet objects and properties. Additional properties allow configuring the built-in light controller applications (constant light, staircase lighting, etc.).

The objects can be grouped in the following categories:

### DALI ballasts

- *Analog Output objects (see Section 6.2.2.10):*
  - Control output light level.
  - Configure DALI ballast parameters.
  - Configure light application parameters (staircase lighting, etc.).
- *Analog Input objects (see Section 6.2.2.11):* Output light level feedback.

### DALI groups

- *Analog Output objects (see Section 6.2.2.10):*
  - Control output light level.
  - Configure light application parameters (staircase lighting, etc.).
- *Analog Input objects (see Section 6.2.2.11):* Output light level feedback.
- *Multi-State Output objects (see Section 6.2.2.12):* Scene control.
- *Accumulator objects (see Section 6.2.2.13):* Accumulated energy usage (calculated).
- *Analog Input objects (see Section 6.2.2.14):* Status and health state of group.

### **DALI channels**

- *Analog Output objects (see Section 6.2.2.10):*
  - Control output light level.
  - Configure light application parameters (staircase lighting, etc.).
- *Analog Input objects (see Section 6.2.2.11):* Output light level feedback.
- *Multi-State Output objects (see Section 6.2.2.12):* Scene control.
- *Accumulator objects (see Section 6.2.2.13):* Accumulated energy usage (calculated).
- *Analog Input objects (see Section 6.2.2.14):* Status and health state of channel.

### **DALI sensors**

- *Analog Input objects (see Section 6.2.3.2):* Lux level sensor value.
- *Binary input objects (see Section 6.2.3.3):* Occupancy sensor value.

### **Constant Light Controller**

- *Loop objects (see Section 6.2.4.10)*

All properties not specifically mentioned in the following sections behave as described by the BACnet standard.

The general BACnet objects and functions not specific to the L-DALI (Device Object, Protocol Parameters, Time Master, Backup & Restore, etc.) are described in the LOYTEC Device User Manual [1].

## **6.2.1 Interface Version**

The BACnet interface can be used in two different modes:

### **Firmware version 1.x compatible interface**

This interface is provided for backward compatibility with projects set up with a L-DALI with firmware version before 2.0.

### **Full featured interface**

This interface is recommended for new projects.

The main difference between the two interface versions is the instance number layout. The “Full featured interface” offers better human readability. Further, new features in future firmware versions may be only available via the full featured interface.

The interface version can be configured via the LINX Configurator project settings (see LINX Configurator User Manual [2]).

## **6.2.2 Light Output Objects**

There are three different types of light output objects:

- Objects related to DALI lamps (64 per channel).
- Objects related to DALI groups (16 per channel).
- Objects related to the DALI channels (1 per channel).

### 6.2.2.1 Control

The L-DALI offers different methods to control lamps.

#### Individual Control

Each lamp can be controlled individually via the *Present\_Value* property of the corresponding Analog Output objects (see Section 6.2.2.10). Any new value received is transmitting to the corresponding DALI lamp in the dimming mode configured with the *Mode* property of the object (property *Fade\_Time* or *Ramp\_Rate* respectively is used to determine dim speed).

#### Group Control

Lamps belonging to a group can be controlled together by the following means:

- **Dimming:** Any new value received via the *Present\_Value* property of the corresponding Analog Output objects (see Section 6.2.2.10) is transmitting to the corresponding DALI group in the dimming mode configured with the *Mode* property of the object (property *Fade\_Time* or *Ramp\_Rate* respectively is used to determine dim speed).
- **Scene control:** Using the *Present\_Value* property of the corresponding Multi-State Output objects (see Section 6.2.2.12) up to 16 DALI scenes can be saved and recalled. The states “*STORE SCENE x*” store the current light levels of all lamps of the group in the specified scene number ‘x’. Alternatively DALI scenes can be configured using the DALI Scenes page in the web interface (see LOYTEC Device User Manual [1]) or the DALI Scenes tab in the LINX Configurator (see LINX Configurator User Manual [2]). By setting the state to “*GO TO SCENE x*” previously stored scenes can be recalled. The state “*AUTOMATIC MODE*” will relinquish any manual override and (re-)activate a constant light controller linked to the group (see Section 6.2.4.4). Scenes can be deleted by a using the states “*REMOVE SCENE x*”. When a new scene is selected the lamp values are adjusted in fading mode (property *Fade\_Time* is used).

#### Channel Control

All lamps on the same DALI channel can be controlled together by the following means:

- **Dimming:** The *Present\_Value* property of the corresponding Analog Output objects works in the same way as for lamps and groups but affects all lamps on a channel.
- **Scene control:** The *Present\_Value* property of the corresponding Multi-State Output objects works in the same way as for groups but affects all lamps on a channel.

### 6.2.2.2 Maximum and Minimum Light Level

For a dimmable lamp the maximum and minimum light level of a lamp can be configured via the properties *Min\_Level* and *Max\_Pres\_Value* of the corresponding Analog Output object.

For a non-dimmable lamp set *Min\_Level* = *Max\_Pres\_Value* = 100%.

### 6.2.2.3 Timing Parameters

Figure 68 shows the behavior of the lamp actuator if the light is switched on/off via one of the Analog Output objects. When the ON command is received, the lamp is switched to the specified value after the time *On\_Delay\_Time* has expired. When the lamp is already on and a new ON command is received the lamp is switched to the new value immediately. If the lamp is on and an OFF command is received the lamp is switched off after the time *Off\_Delay\_Time*.

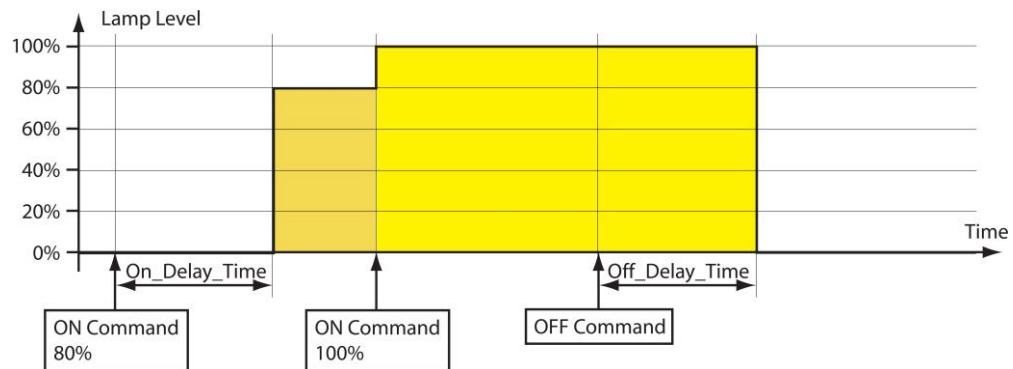

Figure 68: Timing Parameters.

For staircase lighting an automatic cutoff can be configured in *Auto\_Off\_Time* as shown in Figure 69. When this time expires, the lamp switches off automatically. To warn the user that the light is going to turn off, an off-warning delay (*Warn\_Delay*) can be configured. During this time the light is dimmed to 50% of the previous level. For non-dimmable lights (*Min\_Level=Max\_Pres\_Value*) the light is blinking.

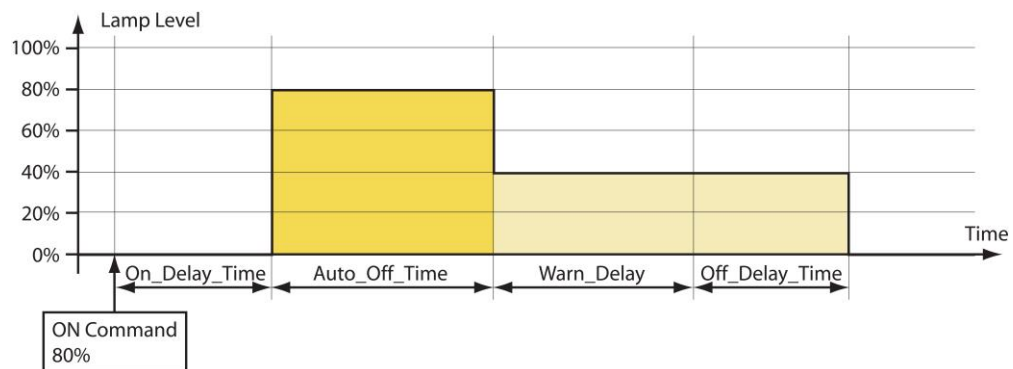

Figure 69: Timing Parameters with *Auto\_Off\_Time* and *Warn\_Delay*.

The behavior of the auto-off timer can be modified with the property *Auto\_Off\_Mode*. If *Auto\_Off\_Mode* is set to *ENABLE\_RESTART* or *ENABLE\_RESTART\_BREAK*, the auto-off timer can be restarted by a new ON command (see Figure 70). If *Auto\_Off\_Mode* is set *ENABLE\_BREAK* or *ENABLE\_RESTART\_BREAK* the auto-off timer can be stopped before the time has expired by switching the light off via the corresponding *Present\_Value* property (see Figure 71).

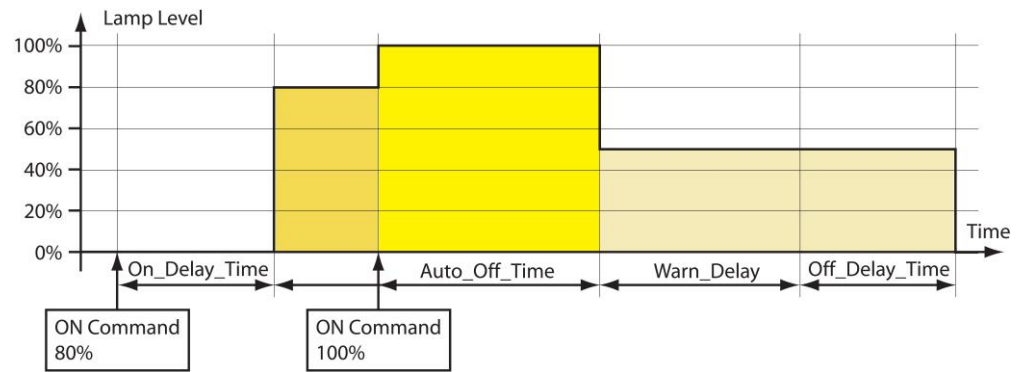

Figure 70: Timing Parameters (restart enabled).

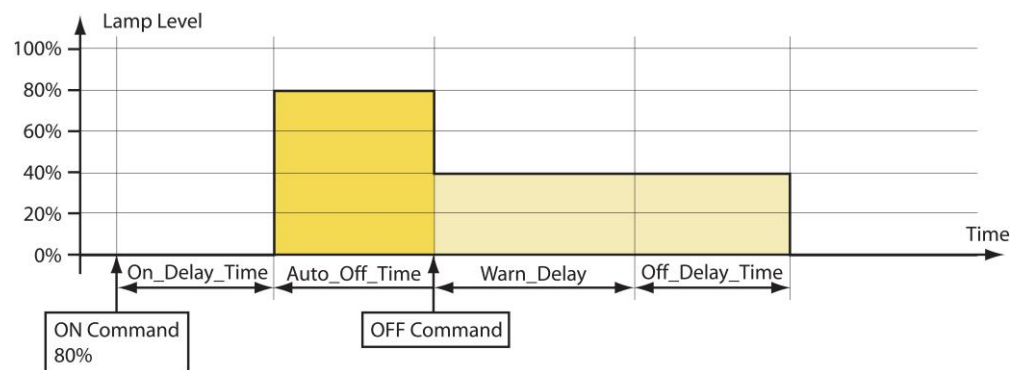

Figure 71: Timing Parameters (break enabled).

#### 6.2.2.4 Feedback

The DALI lamp, group and channel each report the current state via the *Present\_Value* of a feedback Analog Input (see Section 6.2.2.11).

All Analog Output objects report if they are in manual override mode by setting the *OVERRIDDEN* flag in the *Status\_Flags* property.

#### 6.2.2.5 Emergency Lights

The following additional, emergency light related properties are available via the Channel Health Analog Input object (see Section 6.2.2.14):

- *Battery\_Failure*: Report battery failure for each emergency light ballast.
- *Function\_Test\_Failure*: Report whether last function test failed for each emergency light ballast.
- *Duration\_Test\_Failure*: Report whether last function test failed for each emergency light ballast.

#### 6.2.2.6 Status Monitoring

The L-DALI monitors the DALI lamps and reports any failure in the property *Device\_Failure* of the Channel Health Analog Input object (see Section 6.2.2.14). In this property of type BIT STRING each bit corresponds to the lamp with the same index. In case of a failure the bit is set. Similar properties *Lamp\_Failure* and *Ballast\_Failure* are used to signal a lamp or a ballast failure reported by a ballast for each DALI ballast.

A device failure is reported if either

- bus power for the related DALI channel fails,
- the DALI ballast is not reachable via the DALI channel, or
- the DALI ballast reports a failure (e.g. lamp failure) in its DALI status register.

The *Present\_Value* properties of the group and channel related Analog Input objects (see Section 6.2.2.14) reflect the percentage of failed ballasts in this group or channel respectively.

### 6.2.2.7 Statistics

The L-DALI reports the run hours and energy consumptions of the DALI lamps.

#### Run Hours

The L-DALI determines how long each DALI lamp was switched on. The value is reported via the property *Elapsed\_Active\_Time* of the Analog Output object for each lamp, group, and channel (see Section 6.2.2.10). If a lamp is replaced the run hours can be initialized by writing 0 to this property. The time and date of the last reset is stored in the property *Time\_Of\_Active\_Time\_Reset*.

The group related object reports the maximum run hours of all lamps in the groups via the property *Elapsed\_Active\_Time*.

The channel related object reports the maximum run hours of all lamps on the channel via the property *Elapsed\_Active\_Time*.

#### Energy Consumption

The L-DALI device can calculate the energy consumption of the DALI lamps. For that purpose it needs to know the nominal power of all connected DALI lamps. If the configuration property *Nominal\_Power* of a lamp related Analog Output object (see Section 6.2.2.10) is set to 0 (AUTO), the L-DALI tries to obtain the energy consumption from the DALI device. However, not all DALI ballasts support this proprietary extension. In this case the *Nominal\_Power* has to be configured with the nominal power of the ballast.

To reduce the number of objects the energy consumption is reported not separately for each lamp but for a whole group or channel. Accumulator objects (see Section 6.2.2.13) are used to report the sum of energy consumed by all lamps in a group or on a channel respectively. The energy consumption can be reset by writing to the *Value\_Set* property of the Accumulator object

### 6.2.2.8 Burn-In Function

Some lamps require a burn-in time during which they must not be dimmed. The burn-in mode can be activated/deactivated via the Web-UI. The burn-in time is defined by the property *Burn\_In\_Time* available via Analog Output objects corresponding to DALI channels (see Section 6.2.2.10). During this time the lamps will only be switched to on (100%) or off (0%) but not dimmed.

### 6.2.2.9 Fail Safe Functions

The light level a lamp adopts after power-up is defined in the property *Power\_On\_Level*. The light level a lamp adopts in case of a DALI system failure is defined in the

configuration property *System\_Failure\_Level*. Both are available via Analog Output objects corresponding to DALI ballasts (see Section 6.2.2.10).

#### 6.2.2.10 Analog Output Object – Control DALI ballast, group, or channel

This object type is used to control the dim level of DALI ballasts (see Table 11), DALI groups (see Table 12), or DALI channel (see Table 13). For DALI devices it also provides access to all its DALI parameters. Further, parameters for light controller applications are available (e.g. staircase lighting, on and off delays, off warning etc.).

Property Identifier	Property ID	Property Datatype	Conformance Code
Object_Identifier	75	BACnetObjectIdentifier	R
Object_Name	77	CharacterString	R
Object_Type	79	BACnetObjectType	R
Present_Value	85	REAL	W
Description	28	CharacterString	W
Device_Type	31	CharacterString	R
Status_Flags	111	BACnetStatusFlags	R
Event_State	36	BACnetEventState	R
Reliability	103	BACnetReliability	R
Out_Of_Service	81	BOOLEAN	W
Units	117	BACnetEngineeringUnits	R
Min_Pres_Value	69	REAL	R
Max_Pres_Value	65	REAL	W
Priority_Array	87	BACnetPriorityArray	R
Relinquish_Default	104	REAL	W
COV_Increment	22	REAL	W
Time_Delay	113	Unsigned	W
Notification_Class	17	Unsigned	W
High_Limit	45	REAL	W
Low_Limit	59	REAL	W
Deadband	25	REAL	W
Limit_Enable	52	BACnetLimitEnable	W
Event_Enable	35	BACnetEventTransitionBits	W
Acked_Transitions	0	BACnetEventTransitionBits	W
Notify_Type	72	BACnetNotifyType	W
Event_Time_Stamps	130	BACnetARRAY[3] of BACnetTimeStamp	R
Profile_Name	168	CharacterString	R
Power_On_Level	512	REAL	W
System_Failure_Level	513	REAL	W
Fade_Time	514	REAL	W
Ramp_Rate	515	REAL	W
Min_Level	516	REAL	W
Groups	517	BIT STRING	W
Nominal_Power	518	REAL	W
Dim_Mode	520	BACnetDimMode	W
On_Delay_Time	521	Unsigned	W
Off_Delay_Time	522	Unsigned	W
Warn_Delay	523	Unsigned	W
Auto_Off_Time	524	Unsigned	W
Auto_Off_Mode	526	BACnetAutoOffMode	W
Elapsed_Active_Time	527	Unsigned	W
Time_Of_Active_Time_Reset	528	BACnetDateTime	R

Table 11: Properties of the Analog Output object used to control DALI ballasts.



Property Identifier	Property ID	Property Datatype	Conformance Code
Object_Identifier	75	BACnetObjectIdentifier	R
Object_Name	77	CharacterString	R
Object_Type	79	BACnetObjectType	R
Present_Value	85	REAL	W
Description	28	CharacterString	W
Device_Type	31	CharacterString	R
Status_Flags	111	BACnetStatusFlags	R
Event_State	36	BACnetEventState	R
Reliability	103	BACnetReliability	R
Out_Of_Service	81	BOOLEAN	W
Units	117	BACnetEngineeringUnits	R
Min_Pres_Value	69	REAL	R
Max_Pres_Value	65	REAL	W
Priority_Array	87	BACnetPriorityArray	R
Relinquish_Default	104	REAL	W
COV_Increment	22	REAL	W
Time_Delay	113	Unsigned	W
Notification_Class	17	Unsigned	W
High_Limit	45	REAL	W
Low_Limit	59	REAL	W
Deadband	25	REAL	W
Limit_Enable	52	BACnetLimitEnable	W
Event_Enable	35	BACnetEventTransitionBits	W
Acked_Transitions	0	BACnetEventTransitionBits	W
Notify_Type	72	BACnetNotifyType	W
Event_Time_Stamps	130	BACnetARRAY[3] of BACnetTimeStamp	R
Profile_Name	168	CharacterString	R
Dim_Mode	520	BACnetDimMode	W
On_Delay_Time	521	Unsigned	W
Off_Delay_Time	522	Unsigned	W
Warn_Delay	523	Unsigned	W
Auto_Off_Time	524	Unsigned	W
Auto_Off_Mode	526	BACnetAutoOffMode	W
Elapsed_Active_Time	527	Unsigned	W
Time_Of_Active_Time_Reset	528	BACnetDateTime	R

Table 12: Properties of the Analog Output object used to control DALI groups.

Property Identifier	Property ID	Property Datatype	Conformance Code
Object_Identifier	75	BACnetObjectIdentifier	R
Object_Name	77	CharacterString	R
Object_Type	79	BACnetObjectType	R
Present_Value	85	REAL	W
Description	28	CharacterString	W
Device_Type	31	CharacterString	R
Status_Flags	111	BACnetStatusFlags	R
Event_State	36	BACnetEventState	R
Reliability	103	BACnetReliability	R
Out_Of_Service	81	BOOLEAN	W
Units	117	BACnetEngineeringUnits	R
Min_Pres_Value	69	REAL	R
Max_Pres_Value	65	REAL	W
Priority_Array	87	BACnetPriorityArray	R
Relinquish_Default	104	REAL	W
COV_Increment	22	REAL	W
Time_Delay	113	Unsigned	W
Notification_Class	17	Unsigned	W
High_Limit	45	REAL	W
Low_Limit	59	REAL	W
Deadband	25	REAL	W
Limit_Enable	52	BACnetLimitEnable	W
Event_Enable	35	BACnetEventTransitionBits	W
Acked_Transitions	0	BACnetEventTransitionBits	W
Notify_Type	72	BACnetNotifyType	W
Event_Time_Stamps	130	BACnetARRAY[3] of BACnetTimeStamp	R
Profile_Name	168	CharacterString	R
Burn_In_Time	519	Unsigned	W
Dim_Mode	520	BACnetDimMode	W
On_Delay_Time	521	Unsigned	W
Off_Delay_Time	522	Unsigned	W
Warn_Delay	523	Unsigned	W
Auto_Off_Time	524	Unsigned	W
Auto_Off_Mode	526	BACnetAutoOffMode	W
Elapsed_Active_Time	527	Unsigned	W
Time_Of_Active_Time_Reset	528	BACnetDateTime	R

Table 13: Properties of the Analog Output object used to control DALI channels.

**Object\_Identifier (Read-Only)**

The default instance number is ABCC, where “A” is 0 for the objects associated with DALI devices and 1 for the objects associated with DALI groups, and 2 with DALI channels, “B” is the DALI interface number (0-3) in decimal, and “CC” is the DALI device number (00-63) or the DALI group address (00-15) respectively in decimal (00 for DALI channels).

Examples: Ballast 3 on channel 2 has the instance number 103, Group 5 on channel 1 has the instance number 1005, and channel 4 has the instance number 2300.

In compatibility mode the instance number is 0x0ABBCC, where “A” is 0 for the objects associated with DALI devices and 1 for the objects associated with DALI groups, and 2 with DALI channels, “BB” is the DALI interface number (0-3) in hex, and “CC” is the DALI device number (0-63) or the DALI group address (0-15) respectively in hex. Examples: Ballast 3 on channel 2 has the instance number 0x000303 (771), Group 5 on channel 1 has the instance number 0x010205 (66053), and channel 4 has the instance number 0x020300 (131840).

### **Object\_Name (Read-Only)**

This property holds the name of the lamp/group/channel. It can be changed via the Web-UI.

### **Object\_Type (Read-Only)**

The value of this property is ANALOG\_OUTPUT (1).

### **Present\_Value (Read/Write)**

This property, of type REAL, indicates the linearized percentage (0..100.00%) of the device’s desired light output; 0 being off, 1 being dimmest, 100 brightest. It is used to dim the corresponding DALI ballast, group, or channel.

Depending on the *Dim\_Mode* property, a write to this property results in a DALI “DIRECT ARC POWER CONTROL” command (fade) or a series of UP or DOWN commands to the device, group or channel respectively.

### **Description (Read/Write)**

This property can be configured via BACnet. It serves documentation purposes only.

### **Device\_Type (Read-Only)**

This property contains the DALI device type (e.g. “*low voltage halogen lamp*”) for objects mapping to DALI devices, “*DALI group*” for objects mapping to DALI groups and “*DALI channel*” for objects mapping to DALI channels.

### **Status\_Flags (Read-Only)**

Of the four flags the flags IN\_ALARM, FAULT, and OUT\_OF\_SERVICE are linked to the state of the corresponding properties *Event\_State*, *Reliability* and *Out\_Of\_Service* as described by the standard.

**OVERRIDDEN**      Logical TRUE (1) if the associated DALI channel is controlled via the button interface (see Section 4.5.2), FALSE otherwise.

### **Reliability (Read-Only)**

The *Reliability* property for this object type may have any of the following values:

**NO\_FAULT\_DETECTED**      No fault was detected.

**NO\_OUTPUT**      A lamp failure was detected (for groups and channels if at least one lamp failure in the group/on the channel was detected).

COMMUNICATION_FAILURE	Ballast offline (for groups and channels if at least one ballast is offline in the group/on the channel).
UNRELIABLE_OTHER	Other failure detected (e.g. DALI device type specific error, for groups and channels if at least one ballast in the group/on the channel reports a failure)

### **Units (Read-Only)**

The value of this property is 98 (percent).

### **Min\_Pres\_Value (Read-Only)**

The value of this property is 0.

### **Max\_Pres\_Value (Read/Write)**

For objects associated to DALI lamps this property is read/write. Its maximum value is 100. It is mapped to the DALI register MAX\_LEVEL of the corresponding ballast.

For DALI groups and channels this value is always 100 and read only.

### **Profile\_Name (Read-only)**

This property has the following values:

- DALI lamps: “178-<http://www.loytec.com/xsd/DALILampActuator/v1>”
- DALI groups: “178-<http://www.loytec.com/xsd/DALIGroupActuator/v1>”
- DALI channels: “178-<http://www.loytec.com/xsd/DALICHannelActuator/v1>”

### **Power\_On\_Level (Read/Write)**

The value of this proprietary property (property ID 512) corresponds to the “POWER ON LEVEL” in the DALI device. A value of NaN corresponds to MASK.

Only present if the object is associated with a DALI lamp.

### **System\_Failure\_Level (Read/Write)**

The value of this proprietary property (property ID 513) corresponds to the “SYSTEM FAILURE LEVEL” in the DALI device. A value of NaN corresponds to MASK.

Only present if the object is associated with a DALI lamp.

### **Fade\_Time (Read/Write)**

The value of this proprietary property (property ID 514) corresponds to the “FADE TIME” in the DALI device. It gives the time in seconds. The FADE TIME closest to the written value will be used.

Only present if the object is associated with a DALI lamp.

### **Ramp\_Rate (Read/Write)**

The value of this proprietary property (property ID 515) corresponds to the “FADE RATE” in the DALI device. It gives the fade rate in percent per seconds for ramping. The FADE RATE closest to the written value will be used.

Only present if the object is associated with a DALI lamp.

#### **Min\_Level (Read/Write)**

The value of this proprietary property (property ID 516) corresponds to “MIN LEVEL” in the DALI device. It must be in the range  $0 < \text{Min\_Level} \leq 100$ .

Only present if the object is associated with a DALI lamp.

#### **Groups (Read/Write)**

The value of this proprietary property (property ID 517) is a 16-bit wide BIT STRING. It corresponds to the “GROUPS” of the DALI device. It defines the group membership of a lamp. Each bit corresponds to the group of the same index. If the bit is set, the lamp is member of the group.

Only present if the object is associated with a DALI lamp.

#### **Nominal\_Power (Read/Write)**

This proprietary property (property ID 518) is used to specify the nominal power of a DALI ballast. A value of 0 is used to specify AUTO. In this case the nominal power is read from the ballast (if available).

Only present if the object is associated with a DALI lamp.

#### **Burn\_In\_Time (Read/Write)**

This proprietary property (property ID 519) is used to configure the burn in time for the channel. The burn-in mode can be activated/deactivated via the Web-UI.

Only present if the object is associated with a DALI channel.

#### **Dim\_Mode (Read/Write)**

The value of this proprietary property (property ID 520) is used to specify whether to use ramping (1) or fading (0) when changing the current dim level by writing to the *Present\_Value* property.

In case of ramping a constant dim rate is used. Thus, the duration of the dim process depends on the difference between start and target value.

Fading is based on a constant dim duration. Thus, the duration of the dim process does not depend on the difference between start and target value.

#### **On\_Delay\_Time (Read/Write)**

This proprietary property (property ID 521) is used to configure an on-delay time in seconds.

#### **Off\_Delay\_Time (Read/Write)**

This proprietary property (property ID 522) is used to configure an off-delay time in seconds.

#### **Warn\_Delay (Read/Write)**

This proprietary property (property ID 523) is used to configure an off-warning time in seconds. It defines the time during which the user will be notified that the light will be

switched off shortly. During this time, the light is dimmed to 50% of the current level. Lamps which cannot be dimmed (*Min\_Level = Max\_Pres\_Value*) blink during this time.

#### **Auto\_Off\_Time (Read/Write)**

This proprietary property (property ID 524) is used to configure an auto-off time in seconds. It determines the delay after which the lamp output is switched off automatically. The timer is started after receiving a lamp ON command via the *Present\_Value* property

The property *Auto\_Off\_Mode* modifies the behavior of the auto-off timer.

#### **Auto\_Off\_Mode (Read/Write)**

The value of this proprietary property (property ID 526) determines the behavior of the auto-off timer. Possible values are:

DISABLE_ALL (0)	ENABLE_RESTART and ENABLE_BREAK not set.
ENABLE_BREAK (1)	The auto-off-timer can be interrupted by writing to the <i>Present_Value</i> .
ENABLE_RESTART (2)	The auto-off-timer is restarted whenever the <i>Present_Value</i> is written.
ENABLE_RESTART_BREAK (3)	ENABLE_RESTART and ENABLE_BREAK set.

#### **Elapsed\_Active\_Time (Read/Write)**

The value of this proprietary property (property ID 527) gives the accumulated time in seconds, which the corresponding DALI lamp was switched on. For groups or channels it gives the maximum time of all lamps in the group/channel. When writing 0 to this property the value is reset. For groups and channels the value of all lamps in the group/channel are reset.

#### **Time\_Of\_Active\_Time\_Reset (Read-Only)**

The value of this proprietary property (property ID 528) give the time and date the *Elapsed\_Active\_Time* property was last reset.

#### **Intrinsic reporting**

This object supports all properties required for intrinsic reporting. Per default only fault alarms are enabled.

### **6.2.2.11 Analog Input Object – Feedback from DALI ballast, group, or channel**

This object is used to give feedback on the current dim level of DALI ballasts, DALI groups, or DALI channels (see Table 14).

Property Identifier	Property ID	Property Datatype	Conformance Code
Object_Identifier	75	BACnetObjectIdentifier	R
Object_Name	77	CharacterString	R
Object_Type	79	BACnetObjectType	R
Present_Value	85	REAL	R
Device_Type	31	CharacterString	R
Status_Flags	111	BACnetStatusFlags	R
Event_State	36	BACnetEventState	R
Reliability	103	BACnetReliability	R
Out_Of_Service	81	BOOLEAN	W
Units	117	BACnetEngineeringUnits	R
Min_Pres_Value	69	REAL	R
Max_Pres_Value	65	REAL	R
COV_Increment	22	REAL	W
Profile_Name	168	CharacterString	R

Table 14: Properties of the Analog Input object providing feedback from DALI ballasts, groups, and channels.

#### **Object\_Identifier (Read-Only)**

The instance number is equal to the instance number of the corresponding Analog Output object (see Section 6.2.2.10).

#### **Object\_Name (Read-Only)**

This property holds the value of the *Object\_Name* of the associated Analog Output object with the addition “*Feedback*”.

#### **Object\_Type (Read-Only)**

The value of this property is ANALOG\_INPUT (0).

#### **Present\_Value (Read-Only)**

This property, of type REAL, indicates the linearized percentage (0..100.00%) of the DALI device’s, group’s or channel’s current light output.

#### **Device\_Type (Read-Only)**

This property contains the value “*Actual Dim Level*”.

#### **Status\_Flags (Read-Only)**

Of the four flags the flags IN\_ALARM, FAULT, and OUT\_OF\_SERVICE are linked to the state of the corresponding properties *Event\_State*, *Reliability* and *Out\_Of\_Service* as described by the standard.

OVERRIDDEN      Always FALSE.

#### **Reliability (Read-Only)**

The *Reliability* property for this object type may have any of the following values:

NO_FAULT_DETECTED	No fault was detected.
NO_SENSOR	A lamp failure was detected (for groups and channels if at least one lamp failure in the group/on the channel was detected).
COMMUNICATION_FAILURE	Ballast offline (for groups and channels if at least one ballast is offline in the group/on the channel).
UNRELIABLE_OTHER	Other failure detected (e.g. DALI device type specific error, for groups and channels if at least one ballast in the group/on the channel reports a failure)

#### **Units (Read-Only)**

The value of this property is 98 (percent).

#### **Min\_Pres\_Value (Read-Only)**

The value of this property is 0.

#### **Max\_Pres\_Value (Read-Only)**

The value of this property is 100.

#### **Profile\_Name (Read-only)**

This property has the following values:

- DALI lamps: “178-<http://www.loytec.com/xsd/DALILampActuatorFeedback/v1>”
- DALI groups: “178-<http://www.loytec.com/xsd/DALIGroupActuatorFeedback/v1>”
- DALI channels: “178-<http://www.loytec.com/xsd/DALICHannelActuatorFeedback/v1>”

### 6.2.2.12 Multi-State Output Object – Scene Control for DALI group or channel

This object is used to control the dim level of DALI groups and DALI channels via scene control. It has states for scene learning, recalling and clearing (see Table 15).



Property Identifier	Property ID	Property Datatype	Conformance Code
Object_Identifier	75	BACnetObjectIdentifier	R
Object_Name	77	CharacterString	R
Object_Type	79	BACnetObjectType	R
Present_Value	85	Unsigned	W
Status_Flags	111	BACnetStatusFlags	R
Event_State	36	BACnetEventState	R
Out_Of_Service	81	BOOLEAN	W
Number_Of_States	74	Unsigned	R
State_Text	110	BACnetARRAY[N]of CharacterString	W
Priority_Array	87	BACnetPriorityArray	R
Relinquish_Default	104	Unsigned	R
Profile_Name	168	CharacterString	R

Table 15: Properties of the Multi-State Output object used for scene control of DALI groups and channels.

#### **Object\_Identifier (Read-Only)**

The instance number is equal to the instance number of the corresponding Analog Output object (see Section 6.2.2.10).

#### **Object\_Name (Read-Only)**

This property holds the value of the *Object\_Name* of the associated Analog Output object with the addition “*Scene*”.

#### **Object\_Type (Read-Only)**

The value of this property is MULTISTATE\_OUTPUT (14).

#### **Present\_Value (Read/Write)**

The *Present\_Value* property can have the following values:

**GO TO SCENE X (1-16):** Where X is 0-15. Results in recalling the DALI scene X by sending the DALI “GO TO SCENE” command to the DALI group address or DALI broadcast address, which is associated with this Multi-State Output object.

**STORE SCENE X (17-32):** Where X is 0-15. Results in the current values being stored as scene X by sending the DALI “STORE THE DTR AS SCENE” command to the DALI group address or DALI broadcast address, which is associated with this Multi-State Output object.

**REMOVE SCENE X (33-48):** Where X is 0-15. Results in scene X being erased by sending the DALI “REMOVE FROM SCENE” command to the DALI group address or DALI broadcast address, which is associated with this Multi-State Output object.

**AUTOMATIC MODE (49):** Relinquish any manual override and (re-)activate constant light controller linked to the group (see Section 6.2.4.4).

**Status\_Flags (Read-Only)**

Of the four flags the flags IN\_ALARM, FAULT, and OUT\_OF\_SERVICE are linked to the state of the corresponding properties *Event\_State*, *Reliability* and *Out\_Of\_Service* as described by the standard.

OVERRIDDEN      Logical TRUE (1) if the associated DALI channel is controlled via the button interface (see Section 4.5.2), FALSE otherwise.

**Reliability (Read-Only)**

The *Reliability* property of this object type may have any of the following values:

NO\_FAULT\_DETECTED      No fault was detected.

**Number\_Of\_States (Read-Only)**

This property has the value 48.

**State\_Text (Read/Write)**

Per default this property contains the strings “GO TO SCENE X”, “STORE SCENE X”, and “REMOVE SCENE X” respectively.

**Profile\_Name (Read-only)**

This property has the following values:

- DALI groups: “178-<http://www.loytec.com/xsd/DALIGroupSceneCtrl/v1>”
- DALI channels: “178-<http://www.loytec.com/xsd/DALICHannelSceneCtrl/v1>”

### 6.2.2.13 Accumulator Object – Energy usage of DALI group or channel

This object is used to represent the accumulated energy usage of DALI groups and channels (see Table 16).

Property Identifier	Property ID	Property Datatype	Conformance Code
Object_Identifier	75	BACnetObjectIdentifier	R
Object_Name	77	CharacterString	R
Object_Type	79	BACnetObjectType	R
Present_Value	85	UNSIGNED	R
Device_Type	31	CharacterString	R
Status_Flags	111	BACnetStatusFlags	R
Event_State	36	BACnetEventState	R
Reliability	103	BACnetReliability	R
Out_Of_Service	81	BOOLEAN	W
Scale	187	BACnetScale	R
Units	117	BACnetEngineeringUnits	R
Max_Pres_Value	65	Unsigned	R
Value_Change_Time	192	BACnetDateTime	R
Value_Before_Change	190	Unsigned	R
Value_Set	191	Unsigned	W
Time_Delay	113	Unsigned	W
Notification_Class	17	Unsigned	W
High_Limit	45	REAL	W
Low_Limit	59	REAL	W
Deadband	25	REAL	W
Limit_Enable	52	BACnetLimitEnable	W
Event_Enable	35	BACnetEventTransitionBits	W
Acked_Transitions	0	BACnetEventTransitionBits	W
Notify_Type	72	BACnetNotifyType	W
Event_Time_Stamps	130	BACnetARRAY[3] of BACnetTimeStamp	R
Profile_Name	168	CharacterString	R

Table 16: Properties of the Accumulator object representing the accumulated energy usage of DALI groups or channels.

#### **Object\_Identifier (Read-Only)**

The instance number is equal to the instance number of the corresponding Analog Output object (see Section 6.2.2.10).

#### **Object\_Name (Read-Only)**

This property holds the value of the *Object\_Name* of the associated Analog Output object with the addition “Energy”.

#### **Object\_Type (Read-Only)**

The value of this property is ACCUMULATOR (23).

#### **Present\_Value (Read-Only)**

The value of this property, of type UNSIGNED, indicates the accumulated energy usage in Wh. For objects associated to DALI groups/channels this property reports the sum of the accumulated energy usage of all ballasts in the DALI group/channel.

For calculating the energy usage the nominal power of the affected DALI lamps must be known (see Property *Nominal\_Power*, Section 6.2.2.10). The value of this property is just a calculated value and thus is not suitable for billing energy usage.

#### **Device\_Type (Read-Only)**

This property contains the value “*Accumulated Energy Usage*”.

#### **Status\_Flags (Read-Only)**

Of the four flags the flags IN\_ALARM, FAULT, and OUT\_OF\_SERVICE are linked to the state of the corresponding properties *Event\_State*, *Reliability* and *Out\_Of\_Service* as described by the standard.

OVERRIDDEN      Always FALSE.

#### **Reliability (Read-Only)**

The *Reliability* property for this object type may have any of the following values:

NO\_FAULT\_DETECTED      No fault was detected.

UNRELIABLE\_OTHER      Other failure detected.

#### **Scale (Read-Only)**

The value of this property is INTEGER 1.

#### **Units (Read-Only)**

The value of this property is 18 (watt-hours).

#### **Max\_Pres\_Value (Read-Only)**

The value of this property is 4.294.967.295 (maximum unsigned 32-bit value).

#### **Value\_Set (Read/Write)**

This property behaves as defined by the BACnet standard. Resetting the accumulator value is possible via the *Value\_Set* property (*Value\_Set* is writeable, *Value\_Before\_Change* is not writeable).

#### **Profile\_Name (Read-only)**

The value of this property is “178-<http://www.loytec.com/xsd/LightEnergyAccumulator/v1>”.

#### **Intrinsic reporting**

The object supports all properties required for intrinsic reporting. Per default no alarms are enabled.

### 6.2.2.14 Analog Input Object – Health State of DALI group or channel

This object is used to represent the health state of DALI groups (see Table 17) or DALI channels (see Table 18).

Property Identifier	Property ID	Property Datatype	Conformance Code
Object_Identifier	75	BACnetObjectIdentifier	R
Object_Name	77	CharacterString	R
Object_Type	79	BACnetObjectType	R
Present_Value	85	REAL	R
Status_Flags	111	BACnetStatusFlags	R
Event_State	36	BACnetEventState	R
Reliability	103	BACnetReliability	R
Out_Of_Service	81	BOOLEAN	W
Units	117	BACnetEngineeringUnits	R
Min_Pres_Value	69	REAL	R
Max_Pres_Value	65	REAL	R
COV_Increment	22	REAL	W
Time_Delay	113	Unsigned	W
Notification_Class	17	Unsigned	W
High_Limit	45	REAL	W
Low_Limit	59	REAL	W
Deadband	25	REAL	W
Limit_Enable	52	BACnetLimitEnable	W
Event_Enable	35	BACnetEventTransitionBits	W
Acked_Transitions	0	BACnetEventTransitionBits	W
Notify_Type	72	BACnetNotifyType	W
Event_Time_Stamps	130	BACnetARRAY[3] of BACnetTimeStamp	R
Profile_Name	168	CharacterString	R

Table 17: Properties of the Analog Input object representing the health state of a DALI group.

Property Identifier	Property ID	Property Datatype	Conformance Code
Object_Identifier	75	BACnetObjectIdentifier	R
Object_Name	77	CharacterString	R
Object_Type	79	BACnetObjectType	R
Present_Value	85	REAL	R
Status_Flags	111	BACnetStatusFlags	R
Event_State	36	BACnetEventState	R
Reliability	103	BACnetReliability	R
Out_Of_Service	81	BOOLEAN	W
Units	117	BACnetEngineeringUnits	R
Min_Pres_Value	69	REAL	R
Max_Pres_Value	65	REAL	R
COV_Increment	22	REAL	W
Time_Delay	113	Unsigned	W
Notification_Class	17	Unsigned	W
High_Limit	45	REAL	W
Low_Limit	59	REAL	W
Deadband	25	REAL	W
Limit_Enable	52	BACnetLimitEnable	W
Event_Enable	35	BACnetEventTransitionBits	W
Acked_Transitions	0	BACnetEventTransitionBits	W
Notify_Type	72	BACnetNotifyType	W
Event_Time_Stamps	130	BACnetARRAY[3] of BACnetTimeStamp	R
Profile_Name	168	CharacterString	R
Device_Failure	529	BIT STRING	R
Ballast_Failure	530	BIT STRING	R
Lamp_Failure	531	BIT STRING	R
Battery_Failure	532	BIT STRING	R
Function_Test_Failure	533	BIT STRING	R
Duration_Test_Failure	534	BIT STRING	R
Bus_Power	563	BACnetBinaryPV	R
Bus_Power_Failure	564	BACnetBinaryPV	R
Bus_Power_Overload	565	BACnetBinaryPV	R

Table 18: Properties of the Analog Input object representing the health state of a DALI channel.

**Object\_Identifier (Read-Only)**

The default instance number is ABCC, where “A” is 3 for the objects associated with DALI groups, and 4 with DALI channels, “B” is the DALI interface number (0-3) in decimal, and “CC” is the DALI group address (00-15) in decimal (00 for DALI channels). Examples: Group 5 on channel 1 has the instance number 3005, and channel 4 has the instance number 4300.

**Object\_Name (Read-Only)**

This property holds the value of the *Object\_Name* of the associated Analog Output object with the addition “*Status*”.

**Object\_Type (Read-Only)**

The value of this property is ANALOG\_INPUT (0).

**Present\_Value (Read-Only)**

This property reports the percentage of failed ballasts on the corresponding group/channel.

A ballast failure is reported if either

- The bus power for the related DALI channel fails,
- the DALI ballast is not reachable via the DALI channel, or
- the DALI ballast reports a failure (e.g. lamp failure) in its DALI status register.

**Status\_Flags (Read-Only)**

Of the four flags the flags IN\_ALARM, FAULT, and OUT\_OF\_SERVICE are linked to the state of the corresponding properties *Event\_State*, *Reliability* and *Out\_Of\_Service* as described by the standard.

OVERRIDDEN      Always FALSE.

**Reliability (Read-Only)**

The *Reliability* property for this object type may have any of the following values:

NO\_FAULT\_DETECTED      No fault was detected.

**Units (Read-Only)**

The value of this property is 98 (percent).

**Min\_Pres\_Value (Read-Only)**

The value of this property is 0.

**Max\_Pres\_Value (Read-Only)**

The value of this property is 100.

**Profile\_Name (Read-only)**

This property has the following values:

- DALI groups: “178-http://www.loytec.com/xsd/DALIGroupActuatorStatus/v1”
- DALI channels: “178-http://www.loytec.com/xsd/DALIChannelActuatorStatus/v1”

**Device\_Failure (Read-Only)**

The value of this proprietary property (property ID 529) is a 64-bit wide BIT STRING. It contains one bit for each ballast on the channel. If the device fails (offline or failure reported via DALI status bits) the bit is set, otherwise it is cleared.

Only present if the object is associated with a DALI channel.

**Ballast\_Failure (Read-Only)**

The value of this proprietary property (property ID 530) is a 64-bit wide BIT STRING. It contains one bit for each ballast on the channel. If the device reports a ballast failure the bit is set, otherwise it is cleared.

Only present if the object is associated with a DALI channel.

**Lamp\_Failure (Read-Only)**

The value of this proprietary property (property ID 531) is a 64-bit wide BIT STRING. It contains one bit for each ballast on the channel. If the device reports a lamp failure the bit is set, otherwise it is cleared.

Only present if the object is associated with a DALI channel.

**Battery\_Failure (Read-Only)**

The value of this proprietary property (property ID 532) is a 64-bit wide BIT STRING. It contains one bit for each ballast on the channel. If the device reports a battery failure (self-contained emergency lights only) the bit is set, otherwise it is cleared.

Only present if the object is associated with a DALI channel.

**Function\_Test\_Failure (Read-Only)**

The value of this proprietary property (property ID 533) is a 64-bit wide BIT STRING. It contains one bit for each ballast on the channel. If the device reports a function test failure (self-contained emergency lights only) the bit is set, otherwise it is cleared.

Only present if the object is associated with a DALI channel.

**Duration\_Test\_Failure (Read-Only)**

The value of this proprietary property (property ID 534) is a 64-bit wide BIT STRING. It contains one bit for each ballast on the channel. If the device reports a duration test failure (self-contained emergency lights only) the bit is set, otherwise it is cleared.

Only present if the object is associated with a DALI channel.

**Bus\_Power (Read-Only)**

The value of this proprietary property (property ID 563) is *enabled* (active) if the internal bus power is active for the channel and *disabled* (inactive) if not.

**Bus\_Power\_Failure (Read-Only)**

The value of this proprietary property (property ID 564) is *failed* (active) if a DALI bus power failure was detected on the channel or *ok* (inactive) if the DALI bus power is present. A bus power failure is detected independent on whether an internal or an external DALI bus power supply is used.

**Bus\_Power\_Overload (Read-Only)**

The value of this proprietary property (property ID 565) is *overload* (active) if the internal DALI bus power failed due to an overload or *normal* (inactive) if the internal DALI bus power is either disabled/not present or working properly.



### **Intrinsic reporting**

The object supports all properties required for intrinsic reporting. Per default no alarms are enabled.

## **6.2.3 Sensor Objects**

The L-DALI provides objects for 16 DALI sensors per channel. Each sensor is represented by

- an Analog Input object providing the lux level measured by the sensor and
- an Binary Input object providing the occupancy state determined by the sensor.

### **6.2.3.1 Sensor Calibration**

To provide a reliable measurement the light sensor needs to be calibrated. The calibration is best performed with the LINX Configurator software (see LINX Configurator User Manual [2]) or using the Web Interface (see LOYTEC Device User Manual [1]).

### **6.2.3.2 Analog Input Object – DALI lux level sensor**

This object is used to represent the light sensor part of a DALI Sensor (see Table 19). There is a maximum of 16 such objects per channel.

Property Identifier	Property ID	Property Datatype	Conformance Code
Object_Identifier	75	BACnetObjectIdentifier	R
Object_Name	77	CharacterString	R
Object_Type	79	BACnetObjectType	R
Present_Value	85	REAL	R
Device_Type	31	CharacterString	R
Status_Flags	111	BACnetStatusFlags	R
Event_State	36	BACnetEventState	R
Reliability	103	BACnetReliability	R
Out_Of_Service	81	BOOLEAN	W
Units	117	BACnetEngineeringUnits	R
Min_Pres_Value	69	REAL	R
Max_Pres_Value	65	REAL	R
COV_Increment	22	REAL	W
Time_Delay	113	Unsigned	W
Notification_Class	17	Unsigned	W
High_Limit	45	REAL	W
Low_Limit	59	REAL	W
Deadband	25	REAL	W
Limit_Enable	52	BACnetLimitEnable	W
Event_Enable	35	BACnetEventTransitionBits	W
Acked_Transitions	0	BACnetEventTransitionBits	W
Notify_Type	72	BACnetNotifyType	W
Event_Time_Stamps	130	BACnetARRAY[3] of BACnetTimeStamp	R
Profile_Name	168	CharacterString	R
Lux_2	557	REAL	R

Table 19: Properties of the Analog Input object representing a DALI lux level sensor.

#### **Object\_Identifier (Read-Only)**

The default instance number is 5BCC, where “B” is the DALI interface number (0-3) in decimal, and “CC” is the DALI device number (00-15). Example: DALI sensor 4 on channel 2 has the instance number 5104.

#### **Object\_Name (Read/Write)**

This property holds the name of the DALI sensor. It can be changed via the Web-UI.

#### **Object\_Type (Read-Only)**

The value of this property is ANALOG\_INPUT (0).

#### **Present\_Value (Read-Only)**

This property reports the current light level reported by the sensor corrected by the calibration function configured via the gain table (see Section 6.2.3.1).

**Device\_Type (Read-Only)**

This property contains the type of DALI sensor (e.g. “Tridonic Sensor”).

**Status\_Flags (Read-Only)**

Of the four flags the flags IN\_ALARM, FAULT, and OUT\_OF\_SERVICE are linked to the state of the corresponding properties *Event\_State*, *Reliability* and *Out\_Of\_Service* as described by the standard.

OVERRIDDEN      Always FALSE.

**Reliability (Read-Only)**

The *Reliability* property for this object type may have any of the following values:

NO_FAULT_DETECTED	No fault was detected.
NO_SENSOR	No sensor assigned or some failure reported by the DALI sensor (no light value reported).
COMMUNICATION_FAILURE	Sensor offline.
UNRELIABLE_OTHER	Other failure detected.

**Units (Read-Only)**

The value of this property is 37 (lux).

**Min\_Pres\_Value (Read-Only)**

The value of this property is 0.

**Max\_Pres\_Value (Read-Only)**

The value of this property is “Infinity”.

**Profile\_Name (Read-only)**

The value of this property is “178-<http://www.loytec.com/xsd/DALILightSensor/v1>”.

**Lux\_2 (Read-only)**

If the assigned sensor provides multiple lux level sensor values this property (property ID 557) reports the current second light level value reported by the sensor. No gain table correction is applied.

**Intrinsic reporting**

The object supports all properties required for intrinsic reporting. Per default only fault alarms are enabled.

### 6.2.3.3 Binary Input Object – DALI occupancy sensor

This object is used to represent the occupancy sensor part of a DALI Sensor (see Table 20). There is a maximum of 16 such objects per channel.

Property Identifier	Property ID	Property Datatype	Conformance Code
Object_Identifier	75	BACnetObjectIdentifier	R
Object_Name	77	CharacterString	R
Object_Type	79	BACnetObjectType	R
Present_Value	85	BACnetBinaryPV	R
Status_Flags	111	BACnetStatusFlags	R
Event_State	36	BACnetEventState	R
Reliability	103	BACnetReliability	R
Out_Of_Service	81	BOOLEAN	W
Polarity	84	BACnetPolarity	W
Inactive_Text	46	CharacterString	W
Active_Text	4	CharacterString	W
Profile_Name	168	CharacterString	R
Debounce	535	Unsigned	W
Unoccupied_Delay	536	Unsigned	W
Heartbeat	558	Unsigned	W

Table 20: Properties of the Binary Input object representing a DALI occupancy sensor.

**Object\_Identifier (Read-Only)**

The instance number is equal to the instance number of the corresponding Analog Input object (see Section 6.2.3.2).

**Object\_Name (Read-Only)**

This property holds the value of the *Object\_Name* of the associated Analog Input object with the addition “*Occupancy*”.

**Object\_Type (Read-Only)**

The value of this property is BINARY\_INPUT (3).

**Present\_Value (Read-Only)**

This property reports the occupancy status. If the *Polarity* property is *NORMAL* the occupied state corresponds to *ACTIVE*, while the unoccupied state corresponds to *INACTIVE*.

**Status\_Flags (Read-Only)**

Of the four flags the flags IN\_ALARM, FAULT, and OUT\_OF\_SERVICE are linked to the state of the corresponding properties *Event\_State*, *Reliability* and *Out\_Of\_Service* as described by the standard.

OVERRIDDEN      Always FALSE.

**Reliability (Read-Only)**

The *Reliability* property for this object type may have any of the following values:

NO\_FAULT\_DETECTED      No fault was detected.

NO_SENSOR	No sensor assigned or some failure reported by the DALI sensor (no occupancy value reported).
COMMUNICATION_FAILURE	Sensor offline.
UNRELIABLE_OTHER	Other failure detected.

#### **Profile\_Name (Read-only)**

The value of this property is “178-[http://www.loytec.com/xsd/DALIOccupancy\\_Sensor/v1](http://www.loytec.com/xsd/DALIOccupancy_Sensor/v1)”.

#### **Debounce (Read/Write)**

The value of this proprietary property (property ID 535) specifies the debouncing time in seconds (see Section 6.1.3.1).

#### **Unoccupied\_Delay (Read/Write)**

The value of this proprietary property (property ID 536) determines the delay in seconds after which the state changes to unoccupied. The timer is armed each time the value reported by the sensor changes from occupied to unoccupied. A value of 0 disables the unoccupied delay.

#### **Heartbeat (Read/Write)**

The value of this proprietary property (property ID 558) determines the maximum period of time that expires before the object automatically updates its *Present\_Value*. This allows using the *Present\_Value* as occupancy event input to a constant light controller object.

## **6.2.4 Constant Light Controller**

The L-DALI provides 16 constant light controller instances with built in occupancy controller functionality for each DALI channel. Every instance is represented by a BACnet Loop object.

### **6.2.4.1 Interaction with other BACnet Objects**

When using local DALI sensors and/or DALI groups internal manual CLC bindings can be configured in the DALI Parameters tab of the LINX Configurator software (see LINX Configurator User Manual [2]) or the Web-Interface (see Section 6.3.1). The Web-Interface for CLC Bindings can also be used to verify the current status of all bindings (internal and NVs).

Alternatively, the Loop Object allows automatically retrieving its input values from and writing its output values to other BACnet server objects. To reference the property and server object it provides properties of type *BACnetObjectPropertyReference*. Specifically these are:

- *Manipulated\_Variable\_Reference*: Writing *Present\_Value* (Constant Light Controller output, e.g. to Analog Output controlling DALI lights, see Section 6.2.2.10).
- *Controlled\_Variable\_Reference*: Reading lux level input (e.g. from DALI lux level sensor, see Section 6.2.3.2).
- *Setpoint\_Reference*: Reading setpoint value.
- *Occupancy\_Variable\_Reference* (property ID 537): Reading occupancy input (e.g. from DALI occupancy sensor, see Section 6.2.3.3).

Note, that the referenced server object must be local.

#### 6.2.4.2 Setpoint

The desired setpoint for the illumination level is configured via the property *Setpoint*.

#### 6.2.4.3 Operating Modes

The operating mode of the constant light controller is set via the proprietary property *Mode* (property ID 539). Table 21 shows the different operating modes and under which conditions they are used:

Operating Mode	Description
REGULATOR (1)	A light sensor that measures the indoor illumination is installed. An occupancy sensor is installed.
CONTROL (2)	A light sensor that measures the outdoor illumination is installed. An occupancy sensor is installed.
UPDATER (3)	A DALI sensor with constant light controller functionality shall be mapped to the BACnet network. Only the setpoint shall be adjustable via the BACnet interface.
PRESENCE (4)	Based on occupancy the lights shall be switched on and off.
REGULATOR_NO_OCC (5)	A light sensor that measures the indoor illumination is installed. No occupancy sensor is installed.
CONTROL_NO_OCC (6)	A light sensor that measures the outdoor illumination is installed. No occupancy sensor is installed.
MANUAL_ON_AUTO_OFF (7)	Lights are switched on manually, but shall be switched off based on occupancy.
REGULATOR_AUTO (8)	Similar to REGULATOR, but a manual override is automatically relinquished when the room becomes unoccupied.
CONTROL_AUTO (9)	Similar to CONTROL, but a manual override is automatically relinquished when the room becomes unoccupied.
PRESENCE_AUTO (10)	Similar to PRESENCE, but a manual override is automatically relinquished when the room becomes unoccupied.
AMBIENT (11)	Effect or ambient lighting is switched on based on the measured illumination level (switching on ambient lights does not influence measured illumination level).
REGULATOR_BEDROOM (12)	Similar to REGULATOR_AUTO, but a manual override is not automatically relinquished when the lights are overridden to off.
CONTROL_BEDROOM (13)	Similar to CONTROL_AUTO, but a manual override is not automatically relinquished when the lights are overridden to off.

Table 21: Constant Light Controller Operation Modes

#### Regulator Mode

The REGULATOR mode has to be selected if the installed light sensor measures the indoor brightness. The constant light controller receives the current indoor lux level via the

property *Controlled\_Variable\_Value* and adjusts the lamp level (from 0% to 100%) by means of a fuzzy control algorithm.

When the light is switched on the control algorithm selects a lamp value which results in a lux level close to the desired setpoint and then adjusts the lamp value in increments once every second until the configured setpoint is reached. The size of increments is adjusted dynamically but will never exceed the percentage value defined in the proprietary property *Step\_Value* (property ID 544).

The regulator mode is available in different flavors:

- **With our without occupancy sensor:** If an occupancy sensor is installed and the room becomes unoccupied, the current light level is saved and the light is dimmed to unoccupied level (see Section 6.2.4.8). If the room becomes occupied before the light has reached the unoccupied level, the saved light level is restored.
- **With automatic relinquish:** A manual override will be automatically relinquished when the room becomes unoccupied. In a special bedroom mode the automatic relinquish will only take place if the lights are on. If they were switched off manually, the controller does not return to automatic mode when the area turns unoccupied.

### Control Mode

The CONTROL mode has to be selected if the installed light sensor measures the outdoor illumination. The constant light controller receives the current outdoor lux level via the property *Controlled\_Variable\_Value* and sets the lamp level (from 0% to 100%) accordingly (see Figure 60).

The proprietary property *Step\_Value* (property ID 544) ensures that the light level does not change abruptly. Per second the light level is not changed more than the percentage value defined by this configuration property. When the light is switched on or off, *Step\_Value* is not taken into account.

To ensure that the setpoint is reached under all weather conditions, the control curve shown Figure 60 has to be adjusted by calibrating the constant light controller.

The control mode is available in different flavors:

- **With our without occupancy sensor:** If an occupancy sensor is installed and the room becomes unoccupied, the current light level is saved and the light is dimmed to unoccupied level (see Section 6.2.4.8). If the room becomes occupied before the light has reached the unoccupied level, the saved light level is restored.
- **With automatic relinquish:** A manual override will be automatically relinquished when the room becomes unoccupied. In a special bedroom mode the automatic relinquish will only take place if the lights are on. If they were switched off manually, the controller does not return to automatic mode when the area turns unoccupied.

### Presence Mode

The PRESENCE mode has to be if the constant light controller shall operate as occupancy controller. In this mode the light is switched to the value specified in the proprietary property *Occupied\_Level* (property ID 542) if the room is occupied and to the unoccupied level (see Section 6.2.4.8) if the room is unoccupied.

The light is switched to the value *Occupied\_Level* only if the lux level is below *Setpoint* and the room is occupied.

The presence mode is available in different flavors:

- **With or without automatic relinquish:** If automatic relinquish is active a manual override will be automatically relinquished when the room becomes unoccupied.

### Manual-On/Auto-Off Mode

The MANUAL\_ON\_AUTO\_OFF mode is a variation of the PRESENCE mode. However, in this mode the constant light controller does not switch on the lights, when the room becomes occupied. Rather, it switches the lights to the unoccupied level (see Section 6.2.4.8) when the room becomes unoccupied, using the property *Hold\_Time* similar to PRESENCE mode.

Lights can be switched on (or off) via some other DALI master (e.g. a DALI push-button).

### Ambient Mode

The AMBIENT mode is used if effect lighting (e.g. lights in a shop window, facade lighting, floor lights etc.) has to be switched on or off depending on a measured light level. Lights are switched to the value specified in the proprietary property *Occupied\_Level* (property ID 542) when the lux level is below *Setpoint* and to the unoccupied level (see Section 6.2.4.8) when lux level is higher than *Setpoint*.

### Updater Mode

The UPDATER mode has to be selected when a DALI light/occupancy sensor with constant light controller functionality is installed on the DALI network. In this mode no light level computation is performed. The controller simply forwards the parameters to the DALI constant light controller and retrieves lamp setting from the DALI light sensor.

In general, LOYTEC does not recommend using UPDATER mode. Wherever possible use REGULATOR or CONTROL mode instead and use DALI sensors only as lux level and occupancy information source via the corresponding sensor objects. These modes allow improved influence of the constant light controller's parameters via the fieldbus side.

## 6.2.4.4 Prioritized Control

Manual override of the constant light controller can be accomplished in multiple ways:

- Using the priority array of the controlled lamp actuator Analog Output object using a higher priority than the constant light controller.
- Using the *Override* property of the constant light controller Loop object.
- Using a DALI push-button device on groups linked to the constant light controller (see Section 6.2.4.9).
- With a scene recall on groups linked to the constant light controller (see Section 6.2.2.1).

To return to automatic mode the following options exist:

- Set the value of the *Override* property to -1 or invalid.
- Using the button function AUTO of a DALI push-button (e.g. LDALI-BM1) with the destination set to one of the constant light controllers groups (see Section 6.2.4.9).
- Recalling the scene "AUTOMATIC MODE" on the scene controller object of a group linked to the constant light controller (see Section 6.2.2.1).



- When using one of the modes with automatic override relinquish (xxx\_AUTO or xxx\_BEDROOM) the constant light controller will return to automatic mode when it changes its state to unoccupied.

Whether the constant light controller is in automatic mode or in manual/override mode is reflected by the property *Auto\_Mode*.

#### 6.2.4.5 Controlling Multiple Light Bands

The L-DALI constant light controller allows controlling two light bands (groups). The primary light band (Light Band 1) is near the inside of the building, the secondary light band (Light Band 2) is near the window front. Depending on the outdoor light intensity the primary light band has to be brighter than the secondary light band to illuminate the room evenly.

The primary light band is controlled by the *Present\_Value* property of the Loop object. Further for both light bands internal bindings to local DALI groups and their corresponding Analog Output objects can be done (see Section 6.3.1).

The maximum difference between the two light bands can be configured via the configuration property *Lamp\_2\_Offset* as shown in Figure 72. The configuration property *Lamp\_2\_Limit* defines the light level above which the output values of light band 1 and 2 are identical.

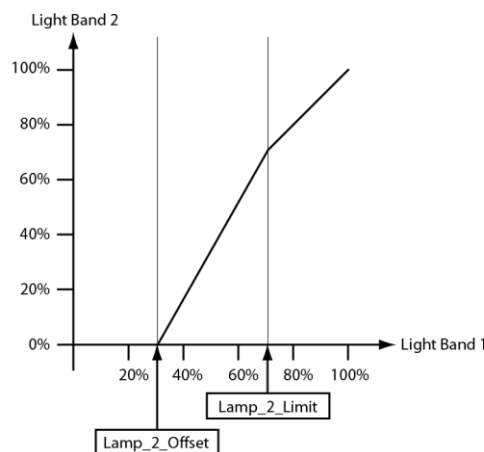

Figure 72: Secondary Light Band

#### 6.2.4.6 Occupancy Detection

The constant light controller receives the occupancy information via the proprietary property *Occupancy\_Variable\_Value* (property ID 538). How this information is evaluated depends on the hold time configured in the proprietary property *Hold\_Time* (property ID 540).

If a hold time is configured (*Hold\_Time* > 0) occupancy evaluation is event based. That is, the constant light controller changes to the occupied state when the value OCCUPIED (1) is received. When the UNOCCUPIED (2) value is received the constant light controller remains in the occupied state until the hold time configured in *Hold\_Time* has expired and then changes to the unoccupied state. Further, if no OCCUPIED is received for the time configured in *Hold\_Time* the constant light controller changes to the unoccupied state, too.

This behavior typically requires the occupancy sensor to send OCCUPIED with a regular interval (heartbeat). It allows using multiple occupancy sensors with the same constant light controller (fan-in). It is the recommended mode if the occupancy information is received via the local DALI occupancy objects (see Section 6.2.3.3).

If no hold time is configured ( $Hold\_Time = 0$ ) occupancy evaluation is state based. That is, the constant light controller changes to the occupied state when the value OCCUPIED is received and to unoccupied state when the value UNOCCUPIED is received.

This behavior is typically required if the occupancy information is only propagated if the state changes (no heartbeat functionality). It does not allow using multiple occupancy (fan-in) sensors without additional logic (e.g. an Occupancy Controller). It is the recommended mode, when using occupancy information from other BACnet devices.

After the light has been switched off any updates on the *Occupancy\_Variable\_Value* input are ignored for the time specified in *Ignore\_Time* (property ID 541).

The current occupancy state calculated by the constant light controller is available via the property *Occupancy\_State* (property ID 562).

### 6.2.4.7 Timing Parameters

To avoid that the constant light controller switches the light on and off repeatedly if the measured lux value is near the setpoint, a hysteresis can be configured. The proprietary property *Off\_Hysteresis* (property ID 546) defines the hysteresis for switching off the lamp and the proprietary property *On\_Hysteresis* (property ID 545) defines the hysteresis for switching on the lamp. In addition a delay can be configured before the lamp is switched on (*On\_Delay*) or off (*Off\_Delay*). Figure 73 illustrates these configuration parameters.

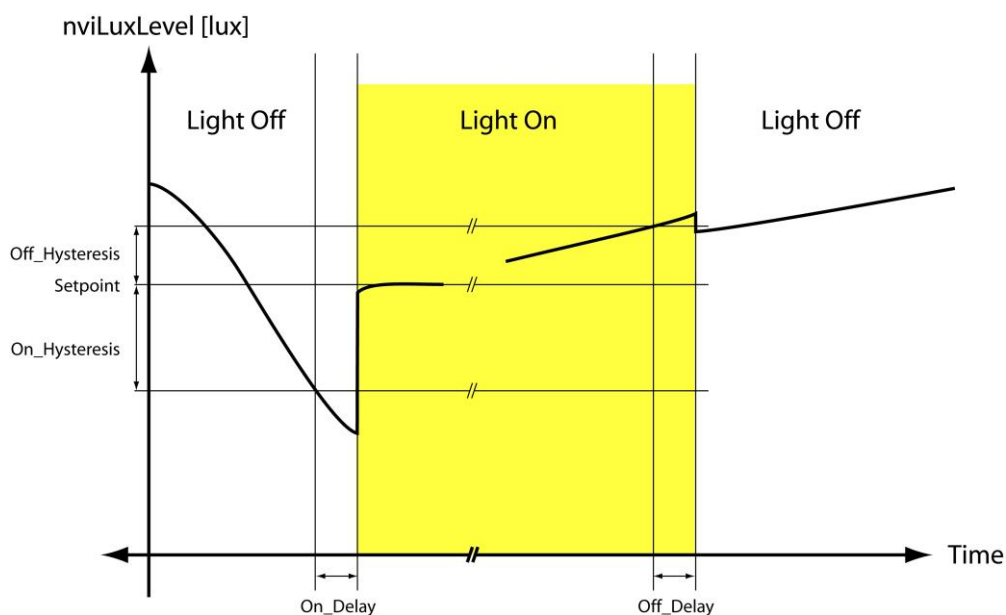

Figure 73: Constant Light Controller Timing.

### 6.2.4.8 Unoccupied Level

If the constant light controller enters unoccupied state (see Section 6.2.4.6) *Unoccupied\_Level* (property ID 543) and *Off\_Delay* (property ID 547) determine the behavior as shown in Table 22.

<i>Unoccupied_Level</i>	<i>Off_Delay</i>	<b>Behavior</b>
0	0	Dim down and switch off lights
> 0	0	Dim down lights to value defined in <i>Unoccupied_Level</i> .
0	> 0	Dim down to 0.5% and switch off lights after <i>Off_Delay</i> .
> 0	> 0	Dim down lights to value defined in <i>Unoccupied_Level</i> and switch off lights after <i>Off_Delay</i> .

Table 22: Behavior of constant light controller when entering unoccupied state.

#### 6.2.4.9 Interaction with DALI Buttons

When internal CLC bindings are used to control DALI groups an override can also be performed using a DALI push-button device like the LDALI-BM1 (or some other DALI master) controlling the same groups as the constant light controller.

Whenever the light level of one of the ballasts controlled by the constant light controller is changed by operating a DALI button the constant light controller will detect this and stop controlling the group and enter override mode. Furthermore, the *Present\_Value* of the Constant Light Controllers Loop Object will be updated with the new feedback value of the group controlled by the DALI button.

See the LOYTEC Device User Manual [1] on how to configure DALI button functions via the web interface and the LINX Configurator User Manual [2] how to configure them via the DALI Parameters tab of the LINX Configurator software.

#### 6.2.4.10 Loop Object – Constant Light Controller application

This object is used to represent a constant light controller instance (see Table 23). There are up to 16 instances per DALI channel available.

Property Identifier	Property ID	Property Datatype	Conformance Code
Object_Identifier	75	BACnetObjectIdentifier	R
Object_Name	77	CharacterString	R
Object_Type	79	BACnetObjectType	R
Present_Value	85	REAL	R
Description	28	CharacterString	W
Status_Flags	111	BACnetStatusFlags	R
Event_State	36	BACnetEventState	R
Reliability	103	BACnetReliability	R
Out_Of_Service	81	BOOLEAN	W
Output_Units	82	BACnetEngineeringUnits	R
Manipulated_Variable_Reference	60	BACnetObjectPropertyReference	W
Controlled_Variable_Reference	19	BACnetObjectPropertyReference	W
Controlled_Variable_Value	21	REAL	W
Controlled_Variable_Units	20	BACnetEngineeringUnits	R
Setpoint_Reference	109	BACnetSetpointReference	W
Setpoint	108	REAL	W
Action	2	BACnetAction	R
Priority_For_Writing	88	Unsigned	W
COV_Increment	22	REAL	W
Profile_Name	168	CharacterString	R
Occupancy_Variable_Reference	537	BACnetObjectPropertyReference	W
Occupancy_Variable_Value	538	BOOLEAN	W
Mode	539	Unsigned	W
Hold_Time	540	Unsigned	W
Ignore_Time	541	Unsigned	W
Occupied_Level	542	REAL	W
Unoccupied_Level	543	REAL	W
Step_Value	544	REAL	W
On_Hysteresis	545	REAL	W
Off_Hysteresis	546	REAL	W
Off_Delay	547	Unsigned	W
On_Delay	548	Unsigned	W
Lamp_2_Offset	550	REAL	W
Lamp_2_Limit	551	REAL	W
Override	560	REAL	W
Auto_Mode	561	BACnetBinaryPV	R
Occupancy_State	562	BACnetBinaryPV	R

Table 23: Properties of the Loop object representing a Constant Light Controller Application.

**Object\_Identifier (Read-Only)**

The default instance number is BCC, where “B” is the DALI interface number (0-3) in decimal, and “CC” is the Constant Light Controller instance on the channel (00-15).

**Object\_Name (Read-Only)**

This property holds the name of the constant light controller.

**Object\_Type (Read-Only)**

The value of this property is LOOP (12).

**Present\_Value (Read-Only)**

This property, of type REAL, indicates the linearized percentage (0..100.00%) of the constant light controller output.

**Description (Read/Write)**

This property can be configured via BACnet. It serves documentation purposes only.

**Reliability (Read-Only)**

The *Reliability* property for this object type may have any of the following values:

NO_FAULT_DETECTED	No fault was detected.
OPEN_LOOP	The sensor value does not change when the output is controlled (CONTROL mode only).
COMMUNICATION_FAILURE	Communication with sensor or light output not working.
UNRELIABLE_OTHER	Other failure detected.

**Output\_Units (Read-Only)**

The value of this property is 98 (percent).

**Manipulated\_Variable\_Reference (Read/Write)**

Specifies the object and property the value of the *Present\_Value* property is written to.

**Controlled\_Variable\_Reference (Read/Write)**

Specifies the object and property the light sensor value is read from.

**Controlled\_Variable\_Value (Read/Write)**

This property holds the current light sensor value as read from *Controlled\_Variable\_Reference*.

**Controlled\_Variable\_Units (Read-Only)**

The value of this property is 37 (lux).

**Setpoint\_Reference (Read/Write)**

Specifies the object and property the setpoint for the constant light controller algorithm is read from.

**Setpoint (Read/Write)**

This property holds the setpoint for the constant light controller algorithm.

**Action (Read-Only)**

The value of this property is DIRECT.

**Profile\_Name (Read-only)**

The value of this property is “178-<http://www.loytec.com/xsd/ConstantLightController/v1>”.

**Occupancy\_Variable\_Reference (Read/Write)**

This proprietary property (property ID 537) specifies the object and property the occupancy sensor value is read from.

**Occupancy\_Variable\_Value (Read/Write)**

This proprietary property (property ID 538) holds the current occupancy sensor value as read from *Occupancy\_Variable\_Reference*.

**Mode (Read/Write)**

This proprietary property (property ID 539) holds the constant light controller operating mode (see Section 6.2.4.3).

**Hold\_Time (Read/Write)**

This proprietary property (property ID 540) holds the hold time for the occupancy state in seconds. When the OCCUPIED (1) value is received via *Occupancy\_Variable\_Value* the constant light controller remains in the occupied state until the hold time has expired and then changes to the unoccupied state. If set to 0 the unoccupied state is entered when UNOCCUPIED (2) is received.

**Ignore\_Time (Read/Write)**

This proprietary property (property ID 541) holds the occupancy ignore time after switching off the light in seconds.

**Occupied\_Level (Read/Write)**

This proprietary property (property ID 542) holds the output levels adopted in the presence modes in occupied state.

**Unoccupied\_Level (Read/Write)**

This proprietary property (property ID 543) holds the output levels adopted in the presence modes in unoccupied state.

**Step\_Value (Read/Write)**

This proprietary property (property ID 544) holds the step value for constant light controller algorithm in percent. It defines the maximum step size that the constant light controller will take to approach the target illumination. Per second the light level is not changed more than the percentage value defined by this configuration property.

**On\_Hysteresis (Read/Write)**

This proprietary property (property ID 545) holds the constant light controller algorithm hysteresis for switching lights on (percent).

The hysteresis is used in CONTROL or REGULATOR mode.

**Off\_Hysteresis (Read/Write)**

This proprietary property (property ID 546) holds the constant light controller algorithm hysteresis for switching lights off (percent).

The hysteresis is used in CONTROL or REGULATOR mode.

**Off\_Delay (Read/Write)**

This proprietary property (property ID 547) holds the constant light controller off delay in seconds.

**On\_Delay (Read/Write)**

This proprietary property (property ID 548) holds the constant light controller on delay in seconds.

**Lamp\_2\_Offset (Read/Write)**

This proprietary property (property ID 550) defines the maximum offset between the output for the primary light band and the secondary light band (see Section 6.2.4.5).

**Lamp\_2\_Limit (Read/Write)**

This proprietary property (property ID 551) specifies the dim level at which the output for the secondary light band becomes identical to the primary output (see Section 6.2.4.5).

**Override (Read/Write)**

This proprietary property (property ID 560) can be used to manually override the constant light controller (see Section 6.2.4.4).

If a valid value is received (0-100%), the constant light controller is disabled and the output is set to the specified value. This also affects the light bands directly linked to the constant light controller. Lamp\_2\_Offset and Lamp\_2\_Limit are not considered.

If an invalid value or a value below 0 (e.g. -1) is received, the constant light controller returns to automatic mode.

When performing an override via a DALI button the data point will reflect the resulting feedback value of the group controlled by the DALI button (see Section 6.2.4.9).

**Auto\_Mode (Read-only)**

This proprietary property (property ID 561) provides the current state of the constant light controller (see Section 6.2.4.4).

Inactive: The constant light controller is disabled or overridden by the data point *Override* or the DALI Mode button/LCD UI.

Active: The constant light controller is enabled and not overridden by the data point *Override* or the DALI Mode button/LCD UI.

**Occupancy\_State (Read-only)**

This proprietary property (property ID 562) provides the current occupancy state calculated by the constant light controller (see Section 6.2.4.6).

Inactive (unoccupied): The area is unoccupied.

Active (occupied): The area is occupied.

## 6.2.5 Button Objects

The current state of a DALI button input can be represented by a BACnet Binary Input object.

### 6.2.5.1 Creating BACnet Objects for DALI Button Inputs

To create BACnet Binary Input objects representing DALI button inputs proceed as follows:

1. Enable Button objects in the BACnet project settings in the LINX Configurator (see LINX Configurator User Manual [2]).

The screenshot shows the 'BACnet Settings' window in the LINX Configurator. The 'L-DALI BACnet Interface' section is expanded, and the 'Button objects' checkbox is checked and circled in red. Other settings include 'Interface Version' set to 'Full featured', 'Lamp Actuator objects' checked, 'Group Actuator objects' checked, 'Channel Actuator objects' checked, 'Sensor objects' checked, and 'Constant Light Controller objects' checked. The 'String encoding' is set to 'ASCII/UTF-8', and the 'Default Polycycle' is 60 sec.

2. Select the DALI button device type in the DALI Installation tab.

Button objects (0/64)

Button Name	Type	Status	Short Addr.	Serial Nr.
0 Button 00	LDALI-BM1	Unassigned (modified)	-	-
1 Button 01	unknown button	Unassigned	-	-
2 Button 02	unknown button	Unassigned	-	-
3 Button 03	unknown button	Unassigned	-	-
4 Button 04	unknown button	Unassigned	-	-
5 Button 05	unknown button	Unassigned	-	-
6 Button 06	unknown button	Unassigned	-	-
7 Button 07	unknown button	Unassigned	-	-
8 Button 08	unknown button	Unassigned	-	-
9 Button 09	unknown button	Unassigned	-	-

3. In the DALI Parameters tab set the button function for the input to “Network Data Point”.

Button	Mode	Function
T1	push-button	Network data point
T2	push-button	Disabled
T3	push-button	Disabled
T4	push-button	Disabled

For each button input with the button function set to “Network Data Point” a separate



Binary Input object will be created. All button inputs belonging to the same DALI button device will be grouped in a folder.

---

*Note:* BACnet objects for DALI button inputs can only be created in the LINX Configurator. Setting the button function to “Network Data Point” in the web interface will not create a BACnet object.

---

### 6.2.5.2 Binary Input Object – Button State

This object is used to represent the button state of DALI button input (see Table 20). The objects are created if required (see Section 6.2.5.1).

Property Identifier	Property ID	Property Datatype	Conformance Code
Object_Identifier	75	BACnetObjectIdentifier	R
Object_Name	77	CharacterString	R
Object_Type	79	BACnetObjectType	R
Present_Value	85	BACnetBinaryPV	R
Status_Flags	111	BACnetStatusFlags	R
Event_State	36	BACnetEventState	R
Reliability	103	BACnetReliability	R
Out_Of_Service	81	BOOLEAN	W
Polarity	84	BACnetPolarity	W
Inactive_Text	46	CharacterString	W
Active_Text	4	CharacterString	W
Profile_Name	168	CharacterString	R

Table 24: Properties of the Binary Input object representing a DALI button input.

#### Object\_Identifier (Read-Only)

The instance number is 1BCCDD, where “B” is the DALI interface number (0-3) in decimal, “CC” is the DALI device number (00-63) and “DD” is the input number (00-99). Example: Input “T2” of a LDALI-BM1 assigned to DALI button 4 on channel 2 has the instance number 110401.

#### Object\_Name (Read-Only)

This property holds the value of the button device as configured in the LINX Configurator DALI Installation tab, complemented by the name of the button input (e.g. “T2”).

#### Object\_Type (Read-Only)

The value of this property is BINARY\_INPUT (3).

#### Present\_Value (Read-Only)

This property reports the button input status. If the *Polarity* property is *NORMAL* the value *ACTIVE* corresponds to a closed input, while the value *INACTIVE* corresponds to an open input.

**Status\_Flags (Read-Only)**

Of the four flags the flags IN\_ALARM, FAULT, and OUT\_OF\_SERVICE are linked to the state of the corresponding properties *Event\_State*, *Reliability* and *Out\_Of\_Service* as described by the standard.

OVERRIDDEN      Always FALSE.

**Reliability (Read-Only)**

The *Reliability* property for this object type may have any of the following values:

NO\_FAULT\_DETECTED      No fault was detected.

NO\_SENSOR      No button assigned or some failure reported by the DALI button.

COMMUNICATION\_FAILURE      Button offline.

UNRELIABLE\_OTHER      Other failure detected.

**Profile\_Name (Read-only)**

The value of this property is “178-<http://www.loytec.com/xsd/DALIButton/v1>”.



---

## 6.3 Web Interface

### 6.3.1 Constant Light Controller Bindings (Commission)

To determine which sensors (occupancy & lux) are used as inputs to and which light groups are controlled by a constant light controller instance go to the **CLC Bindings** page (see Figure 74).

Again, selected the DALI channel by clicking on the different tabs at the top of the page labeled **Channel 1**, **Channel 2**, etc.

Click on the  symbol to add an input or output. Use the drop down box to select a sensor (input) or a light group (output). Click on  symbol to remove an input or output.

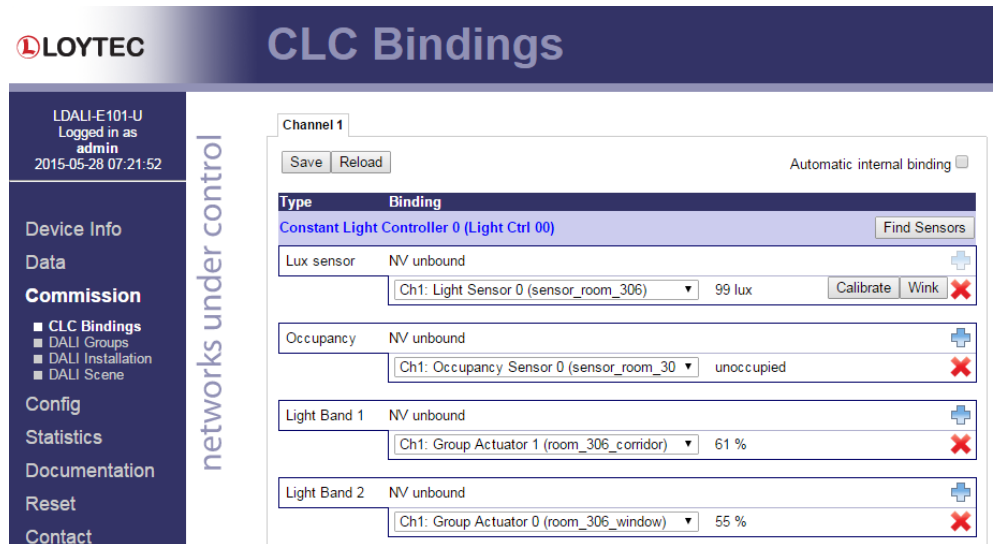

Figure 74: CLC Bindings.

For each constant light controller one lux level sensor, but up to 16 occupancy sensor inputs can be configured. Whenever at least one occupancy sensor reports occupancy the area controlled by the controller instance is considered occupied.

Similar for each of the two light bands up to 16 DALI groups can be selected as outputs. The primary light band is near the inside of the building, the secondary light band is near the window front. Depending on the outdoor light intensity the primary light band has to be brighter than the secondary light band to illuminate the room evenly.

On the LDALI-10X NV bindings can be used in parallel to the internal CLC bindings. The binding status of the corresponding NV is displayed (NV bound/unbound). To enable manual internal CLC bindings the automatic binding algorithm has to be disabled by unchecking the **Automatic internal binding** checkbox. See Section 6.1.4.1 for details on the automatic internal binding algorithm.

On the LDALI-20X the BACnet **Write priority** for the outputs (light bands) can be configured. This priority will be used by the Constant Light Controller application to write to the corresponding Analog Output object controlling the light group.

Once at least one output is configured the button **Find sensors** appears. Click on the button to start a wizard, which automatically tries to find the DALI sensors belonging to the configured light bands. The wizard will switch the light bands on and off. All sensors, which change their lux level reading when switching lights on and off will be considered to belong to the constant light controller instance. The wizard will chose one of the sensors as lux sensor and will add all sensors as occupancy sensor.

Click on the name to jump to the data point configuration page of the fieldbus object corresponding to the Constant Light Controller instance. Once saved the current lux and occupancy sensor reading and the current light level output of the configured groups will be displayed.

To calibrate a lux level sensor click on the **Calibrate** button next to it. This will open the DALI Sensor Calibration page as described in the LOYTEC Devices User Manual [1], with the sensor's Constant Light Controller instance selected.

### 6.3.2 Debug (Config)

Log messages can be activated for each LONMARK or BACnet Object present on the L-DALI to allow analyzing the light and the sunblind applications (see Figure 75).

**LOYTEC** **Debug Mask**

LDALI-3E104  
Logged in as  
admin  
2015-05-28 13:33:20

networks under control

Device Info  
Data  
Commission  
Config  
Statistics  
Documentation  
Reset  
Contact  
Logout

■ Port Config  
■ E-mail  
■ System  
■ Passwords  
■ Backup/Restore  
■ Debug  
■ Firmware  
■ Documentation

Debug Log | **Debug Mask**

**Edit Debug Mask**

Type: all Channel: all Object Index: all

Log Inputs  
 Log Outputs  
 Log State

Save

**Current Debug Mask**

Type.Channel.Object	Input	Output	State
group_act0.1	yes	yes	yes
group_act0.2	yes	yes	yes
group_act0.3	yes	yes	yes
group_act0.4	yes	yes	yes
group_act0.6	yes	yes	yes
group_act0.7	yes	yes	yes
group_act0.8	yes	yes	yes
group_act0.9	yes	yes	yes
group_act0.10	yes	yes	yes
group_act0.11	yes	yes	yes
channel_act0.0	yes	yes	yes
light_ssr.0.0	yes	yes	yes
light_ssr.0.1	yes	yes	yes
light_ssr.0.2	yes	yes	yes
occup_ssr.0.1	yes	yes	yes
occup_ssr.0.2	yes	yes	yes
light_ctrl.0.1	yes	yes	yes

Figure 75: Setup Debug Mask.

The debug log allows recording all changes on inputs and outputs as well as all application internal transitions in case a fieldbus object does not behave as expected. Debug logs are stored in RAM. The messages logged are in most cases self-explanatory.

Further, LOYTEC support requires a debug log to be able to analyze any potential problems. Therefore, such a log should be created before contacting LOYTEC support.

To enable debugging on one or more objects, specify the desired object(s) by setting a filter using the **Type**, **Channel** and **Object Index** drop down boxes. Then check the **Log Input/Log Output/Log State** check boxes and click on the **Save** button.

To disable debugging select the object(s) by specifying a filter like when enabling debugging, leave the checkboxes **Log Input/Log Output/Log State** unchecked and click on the **Save** button.

**LOYTEC** **Debug Log**

LDALI-3E104  
Logged in as  
admin  
2015-05-28 13:33:55

Device Info  
Data  
Commission  
Config  

- Port Config
- E-mail
- System
- Passwords
- Backup/Restore
- Debug
- Firmware
- Documentation

 Statistics  
Documentation  
Reset  
Contact  
Logout

networks under control

Debug Log | Debug Mask

Adjust debug log file size (maximum size 1048576)  
1048576 | Save

Clear Log | Update Log | Save Log

```

2015-05-28 13:03:46.139 light_ctrl.0.6 (dpal_fb_input_cov_cb) nviOccup = OC_UNOCCUPIED
2015-05-28 13:03:46.313 light_ctrl.1.1 (dpal_fb_input_cov_cb) nviLuxLevel = 5866.00
2015-05-28 13:03:46.384 light_ssr.0.1 (dpal_dev_input_cov_cb) lux = 285.00
2015-05-28 13:03:46.386 light_ssr.0.1 (dpal_dev_input_cov_cb) change (407.89) > delta (83.55)
2015-05-28 13:03:46.388 light_ssr.0.1 (set_fb_lux_level) nvoLuxLevel = 3750.00
2015-05-28 13:03:46.562 light_ctrl.0.3 (dpal_fb_input_cov_cb) nviLuxLevel = 3750.00
2015-05-28 13:03:46.622 global.0.0 (dpal_global_input_cov_cb) nviRain = 0
2015-05-28 13:03:46.632 global.1.0 (dpal_global_input_cov_cb) nviRain = 0
2015-05-28 13:03:46.727 light_ctrl.1.8 (dpal_fb_input_cov_cb) nviLuxLevel = 5485.00
2015-05-28 13:03:46.818 global.0.0 (dpal_global_input_cov_cb) nviRain = 0
2015-05-28 13:03:46.825 global.1.0 (dpal_global_input_cov_cb) nviRain = 0
2015-05-28 13:03:47.298 light_ctrl.0.4 (dpal_fb_input_cov_cb) nviOccup = OC_OCCUPIED
2015-05-28 13:03:47.298 light_ctrl.0.4 (occupancy_update) start timer hold occ (event based occupied)
2015-05-28 13:03:47.602 sbind_ctrl.1.2 (dpal_fb_input_cov_cb) nviIllumLev = 1880.00
2015-05-28 13:03:47.628 light_ctrl.1.3 (dpal_fb_input_cov_cb) nviLuxLevel = 1880.00
2015-05-28 13:03:47.717 sbind_ctrl.1.3 (dpal_fb_input_cov_cb) nviIllumLev = 1880.00
2015-05-28 13:03:47.883 light_ctrl.2.0 (dpal_fb_input_cov_cb) nviLuxLevel = 3305.00
2015-05-28 13:03:47.968 light_ctrl.2.3 (dpal_fb_input_cov_cb) nviLuxLevel = 8047.00
2015-05-28 13:03:48.035 light_ctrl.0.5 (dpal_fb_input_cov_cb) nviLuxLevel = 1755.00
2015-05-28 13:03:48.106 global.0.0 (dpal_global_input_cov_cb) nviSunAzimuth = 185.70
2015-05-28 13:03:48.116 global.1.0 (dpal_global_input_cov_cb) nviSunAzimuth = 185.70
2015-05-28 13:03:48.706 light_ssr.0.0 (dpal_dev_input_cov_cb) lux = 476.00
2015-05-28 13:03:48.708 light_ssr.0.0 (dpal_dev_input_cov_cb) change (553.87) > delta (84.53)
2015-05-28 13:03:48.709 light_ssr.0.0 (set_fb_lux_level) nvoLuxLevel = 3934.93
  
```

Figure 76: Debug Log.

# 7 Security Hardening Guide

This guide contains security-relevant information for operating the product on IT networks. The information refers to the firmware version and the instructions found in the previous chapters of this User Manual.

---

## 7.1 Installation Instructions

Install the device over the Web interface:

- Set up the basic device functions and protocol settings as described in Section 3.1.2.
- Disable the FTP, and Telnet servers in the IP port configuration as described in the LOYTEC Device User Manual [1].

Connect a serial console cable:

- Connect to the console as described in the LOYTEC Device User Manual [1].
- Go to menu [3] system configuration.
- Disable the Web server in option [9].
- Save the settings by hitting [x] for exit and save.

---

## 7.2 Firmware

The device is equipped with one piece of software. This is the firmware image and its related firmware version. The firmware is distributed as a downloadable file. The device can be upgraded by placing the firmware image onto the device using the procedure described in the LOYTEC Device User Manual [1].

---

## 7.3 Ports

This Section lists all ports, which may be used by the device. The ports are default settings for their respective services. If not stated otherwise, the ports can be changed.

Required Ports:

- 80 tcp: This port is opened by the Web server and the OPC XML-DA server. It can be disabled if OPC XML-DA is not required. The port can be changed.
- 1628 udp/tcp: This is the data exchange port for CEA-852 (LON over IP). It is required for the primary function of the device to exchange control network data between

routers over the IP network. Each device needs this port open. The port can be changed.

- 47808 udp: This is the data exchange port for BACnet/IP. It is required for the primary function of the device to exchange control network data between routers over the IP network. Each device needs this port open. The port can be changed.

Optional ports not necessary for the primary product function. They can be disabled as described in the installation instructions in Section 7.1:

- 21 tcp: This port is opened by the FTP server. The port can be changed and disabled.
- 23 tcp: This port is opened by the Telnet server. The port can be changed and disabled.

---

## 7.4 Services

Required services:

- CEA-852 (LON over IP): Primary function of the device. This service is in accordance with the standard ANSI/CEA-852-B.
- BACnet/IP: Primary function of the device. This service is in accordance with the standard ANSI/ASHRAE 135-2010.
- OPC XML-DA: This Web service provides access to data points over the OPC XML-DA standard.

Optional services not necessary for the primary product function. They can be disabled as described in the installation instructions in Section 7.1:

- HTTP: Web server. It provides a Web-based configuration UI. The Web UI can be disabled after setting up the device.
- FTP and Telnet: The FTP and Telnet server is used for connection to the device by the Configurator for configuration, firmware upgrade, and access to the log file. On devices without SSH these services must be enabled during device configuration.

---

## 7.5 Logging and Auditing

The device contains a log file, which can be read out over FTP or the Web server. This log contains information when the device started and when crucial communication errors occur. Other information such user log-on are not logged as they are not part of the primary services of this device.

Logged events:

- Time of the last power-on reset of the L-DALI device.
- Time and version of the last firmware upgrade.
- Time when the device configuration has been cleared or the device was reset to factory defaults.
- Commission of the CEA-709 nodes.
- Static errors in the device and data point configuration.
- System overload situations as one-time log messages since last power-on.
- Crucial communication errors as they occur.

# 8 Specifications

---

## 8.1 Physical Specifications

### 8.1.1 LDALI-3E10X-U/LDALI-ME20X-U

Operating Voltage	85-240 V AC, 50/ 60 Hz
Power Consumption	typ. 7,5 W
Operating Temperature (ambient)	0°C to + 50°C
Storage Temperature	10°C to +85°C
Humidity (non condensing) operating	10 to 90% RH @ 50°C
Humidity (non condensing) storage	10 to 90% RH @ 50°C
Enclosure	Installation enclosure 9 TE, DIN 43 880
Environmental Protection	IP 40 (enclosure); IP 20 (screw terminals)
Installation	DIN rail mounting (EN 50 022) or wall mounting

### 8.1.2 LDALI-3E10X/LDALI-ME204

Operating Voltage	12-35 VDC or 12-24 VAC $\pm$ 10%
Power Consumption	typ. 3 W
In rush current	up to 950 mA @ 24 VAC
Operating Temperature (ambient)	0°C to + 50°C
Storage Temperature	10°C to +85°C
Humidity (non condensing) operating	10 to 90% RH @ 50°C
Humidity (non condensing) storage	10 to 90% RH @ 50°C
Enclosure	Installation enclosure 9 TE, DIN 43 880
Environmental Protection	IP 40 (enclosure); IP 20 (screw terminals)



Installation	DIN rail mounting (EN 50 022) or wall mounting
--------------	--

### 8.1.3 LDALI-3101-U/LDALI-E101-U/LDALI-E201-U

Operating Voltage	85-240 VAC 50/60 Hz
Power Consumption	typ. 7.5 W
Operating Temperature (ambient)	0°C to + 50°C
Storage Temperature	10°C to +85°C
Humidity (non condensing) operating	10 to 90% RH @ 50°C
Humidity (non condensing) storage	10 to 90% RH @ 50°C
Enclosure	Installation enclosure 6 TE, DIN 43 880
Environmental Protection	IP 40 (enclosure); IP 20 (screw terminals)
Installation	DIN rail mounting (EN 50 022) or wall mounting

## 8.2 Resource Limits

Table 25 and Table 26 specify the resource limits of the different L-DALI models.

Limits	Model							
	3E102	3E104	3101-U	E101-U	3E101-U	3E102-U	3E104-U	
<b>OPC Tags</b>	2000	2000	-	2000	10000	10000	10000	
<b>User Registers</b>	1000	1000	1000	1000	2000	2000	2000	
<b>Address table entries/legacy<sup>1</sup></b>	512/15	512/15	512/15	512/15	512/15	512/15	512/15	
<b>Alias NVs<sup>1</sup></b>	1000	1000	1000	1000	1000	1000	1000	
<b>LONMARK Calendar objects/patterns per object</b>	2/10	4/10	1/10	1/10	4/10	4/10	4/10	
<b>LONMARK Scheduler objects</b>	32	64	16	16	64	64	64	
<b>LONMARK Alarm Servers</b>	2	4	1	1	4	4	4	
<b>Trend Logs</b>	50	100	25	25	512	512	512	
<b>Total trended data points</b>	256	256	256	256	1000	1000	1000	
<b>Total aggregated size</b>	1MB	1MB	1MB	1MB	60MB	60MB	60MB	
<b>E-mail templates</b>	100	100	100	100	100	100	100	
<b>Math objects</b>	100	100	100	100	100	100	100	
<b>Alarm Logs</b>	10	10	10	10	10	10	10	
<b>L-WEB Clients (concurrent)</b>	8	8	-	8	32	32	32	
<b>Connections (local)</b>	1000	1000	1000	1000	2000	2000	2000	
<b>Connections (global)</b>	250	250	-	250	250	250	250	

Table 25: Resource limits of different LDALI-10X models

<sup>1</sup> Per CEA-709 interface.

Limits \ Model	Model			
	ME204	E201-U	ME201-U	ME204-U
OPC Tags	2000	2000	10000	10000
User Registers	1000	1000	2000	2000
BACnet client mappings	1000	1000	1000	1000
BACnet scheduler objects	64	16	16	16
BACnet calendar objects	8	8	8	8
BACnet notification classes	16	4	4	4
Trend Logs	100	25	512	512
Total trended data points	256	256	1000	1000
Total aggregated size	1MB	1MB	60MB	60MB
E-mail templates	100	100	100	100
Math objects	100	100	100	100
Alarm Logs	10	10	10	10
L-WEB Clients (concurrent)	8	8	32	32
Connections (local)	1000	1000	2000	2000
Connections (global)	250	250	250	250

Table 26: Resource limits of different LDALI-20X models.

### 8.3 FCC Warning

This device has been tested and found to comply with limits for a Class B digital device, pursuant to Part 2 and 15 of FCC Rules. These limits are designed to provide reasonable protection against harmful interference when the equipment is operated in a commercial environment. This equipment generates and radiates radio frequency energy and, if not installed and used in accordance with the user's manual, it may cause interference in which case users will be required to correct interference at their own expenses.

### 8.4 CE Warning

This is a Class B product. In a domestic environment, this product may cause radio interference in which case the user may be required to take adequate measures.

## 9 References

- [1] LOYTEC Device User Manual, LOYTEC electronics GmbH, Document № 88086501, March 2016.
- [2] LINX Configurator User Manual, LOYTEC electronics GmbH, Document № 88086701, March 2016.
- [3] NIC User Manual 4.2, LOYTEC electronics GmbH, Document № 88067217, April 2013.
- [4] LWEB-802/803 User Manual 2.3, LOYTEC electronics GmbH, Document № 88074216, March 2014.
- [5] LWEB-900 User Manual 2.0, LOYTEC electronics GmbH, Document № 88081505, April 2015.
- [6] L-VIS User Manual 5.1, LOYTEC electronics GmbH, Document № 88068520, February 2015.
- [7] LIOB-10x/x5x User Manual 5.0, LOYTEC electronics GmbH, Document № 88078510, April 2014.
- [8] L-IP User Manual 6.1, LOYTEC electronics GmbH, Document № 88065912, October 2015.
- [9] LIP-ME201 User Manual 5.3, LOYTEC electronics GmbH, Document № 88073508, July 2015.

# 10 Revision History

Date	Version	Author	Description
07-05-2010	1.0	AD	Initial revision V1.0
15-06-2010	1.0.1	JB	Minor corrections
08-11-2010	1.1	JB	Updated for L-DALI firmware 2.1 and Configurator 1.1
16-09-2011	2.0	JB	Cover LDALI-ME20X (BACnet) firmware 2.2 Minor improvements related to LDALI-3E10X documentation
14-11-2011	2.0.1	JB	Minor corrections and improvements
29-06-2012	3.0	JB	Cover LDALI-3E10X firmware 3.0 and LDALI Configurator 3.0
07-09-2012	3.0.1	JB	Minor corrections
11-10-2013	3.1	JB	Cover LDALI-10X/20X firmware 3.1 and LDALI Configurator 3.1. Cover LDALI-E101-U, LDALI-3101-U and LDALI-E201-U.
13.08.2014	3.2	JB	Cover LDALI-10X/20X firmware 3.2 and LDALI Configurator 3.2. Cover LDALI-E101-U, LDALI-3101-U and LDALI-E201-U versions with Dual-Ethernet and internal DALI PS which can be switched off.
27.05.2015	5.2	JB	Cover LDALI-10X/20X firmware 5.2 and LINX Configurator 5.2 (replacing LDALI Configurator). Cover LDALI-MS1 and LDALI-BM1. Added more info on DALI basics and troubleshooting info. Added Property IDs for BACnet standard properties.
25.03.2016	6.0	JB	Re-organized User Manual structure, branched out common parts into LOYTEC Device User Manual and LINX Configurator User Manual. Cover LDALI-10X/20X firmware 6.0 and LINX Configurator 6.0. Cover LDALI-3E10X-U and LDALI-ME20X-U models.