

AQR253...

AQR254...

Symaro™

Flush-mount room sensor **AQR253...** **AQR254...**

- Active flush-mounted room sensor comprising front module, base module and design frame accessory that can be ordered separately
- Operating voltage AC 24 V or DC 15-36 V
- Adjustable signal outputs:
DC 0-10 V; DC 2-10 V; DC 0-5 V;
DC 0-20 mA; DC 4-20 mA; DC 0-10 mA;
- Maintenance-free CO₂ sensing element based on optical infrared absorption measurement (NDIR¹⁾)
- VOC²⁾ sensing element based on a heated tin dioxide semi-conductor
- Determination of air quality (IAQ³⁾) by maximum selection from CO₂ and VOC sensing signals
- CO₂ value indicated by LED
- Field of use 0...+50 °C / 0...95 % r.h. (non-condensing) / 0...2000 ppm
- Active multi-sensor for CO₂-temperature, CO₂-humidity, and humidity-temperature
- Passive temperature sensor (LG-Ni1000 / NTC 10k)

1) NDIR = Non-dispersive infrared

2) VOC = Volatile organic compounds

3) IAQ = Indoor air quality

Use

In ventilation and air conditioning plants, to optimize comfort and energy consumption based on demand-controlled ventilation.

The room sensor records:

- CO₂ concentration to indicate presence in smoke-free rooms.
- VOC concentration to indicate presence of odors in rooms, e.g. from tobacco smoke, body odor, material fumes.
- Relative humidity in the room.
- Temperature in the room.

Typical use:

- Measure CO₂ and VOC concentration:

In party rooms, foyers, exposition and exhibition halls, canteens, shopping malls, sports facilities, sales rooms, meeting rooms, residential rooms.

- Measure CO₂ concentration:

In rooms with varying occupancy with regard to time or number of persons, smoke-free rooms such as museums, theaters, movie theaters, lecture halls, offices, classrooms.

Note

Devices for CO₂ or VOC measurement are not suited for safety applications such as: Warning against presence of gas or smoke.

Type summary

The mounted sensor comprises a front module, base module with mounting plate as well as design frame that can be ordered separately (see "Accessories").

Front module





<i>Product number</i>	<i>Stock number</i>	<i>Humidity measuring range</i>	<i>Temperature measuring range</i>	<i>Air quality indication</i>
AQR2530NNW	S55720-S137	---	---	---
AQR2532NNW	S55720-S136	---	0-50 °C	---
AQR2533NNW	S55720-S140	0-100 % r.h.	---	---
AQR2535NNW	S55720-S141	0-100 % r.h.	0-50 °C	---
AQR2535NNWQ	S55720-S219	0-100 % r.F.	0-50 °C	LED
AQR2534ANW	S55720-S138	0-100 % r.h.	0-50 °C and LG-Ni1000	---
AQR2534FNW	S55720-S139	0-100 % r.h.	0-50 °C and NTC 10k	---

Base module

<i>Product number</i>	<i>Stock number</i>	<i>CO₂ measuring range</i>	<i>VOC measuring range</i>
AQR2540N... ¹⁾	<i>Number depends on mounting plate and frame format. See Type summary in the product catalog</i>	---	---
AQR2547N... ¹⁾		---	0-100 %
AQR2546N... ¹⁾		0-2000 ppm ²⁾	---
AQR2548N... ¹⁾		0-2000 ppm ²⁾	0-100 %

1) ASN product number supplement depends on mounting plate format (see table below)

2) ppm = Parts per million

<i>Mounting plate format</i>			<i>ASN supplement</i>
	CEE/VDE	70.8 x 70.8 mm	...F
	British Standard	83 x 83 mm	...H
	3 Modular	110 x 64 mm	...G
	UL	64 x 110 mm	...J

Ordering

When ordering, provide both name and type reference of the sensor, e.g.:

- Room sensor front module: AQR2532NNW / S55720-S136
- Room sensor base module (British Standard): AQR2540NH / S55720-S143

Place a separate order for the design frames AQR2500N...W listed in the "Accessories" section.

Overview of module combinations and sensor functions

Sensor modules				Module types (ASN)			Sensor output			Relay output ²⁾
Base module	Front module			Base module	+	Front module	X1	X2	B, M	C, DO
			T	AQR2540...	+	AQR2532...	---	T		T
		r.h.		AQR2540...	+	AQR2533...	r.h.	---		r.h.
		r.h.	T	AQR2540...	+	AQR2535...	r.h.	T		r.h. / T
		r.h.	T	¹⁾ AQR2540...	+	AQR2534...	r.h.	T	¹⁾	r.h. / T
	VOC			AQR2547...	+	AQR2530...	VOC	---		VOC
	VOC		T	AQR2547...	+	AQR2532...	VOC	T		VOC / T
	VOC	r.h.		AQR2547...	+	AQR2533...	VOC	r.h.		VOC / r.h.
	VOC	r.h.	T	AQR2547...	+	AQR2535...	VOC	r.h.		VOC / r.h. / T
	VOC	r.h.	T	¹⁾ AQR2547...	+	AQR2534...	VOC	r.h.	¹⁾	VOC / r.h. / T
CO ₂				AQR2546...	+	AQR2530...	CO ₂	---		CO ₂
CO ₂			T	AQR2546...	+	AQR2532...	CO ₂	T		CO ₂ / T
CO ₂		r.h.		AQR2546...	+	AQR2533...	CO ₂	r.h.		CO ₂ / r.h.
CO ₂		r.h.	T	AQR2546...	+	AQR2535...	CO ₂	r.h.		CO ₂ / r.h. / T
CO ₂		r.h.	T	AQR2546...	+	AQR2535...Q	CO ₂	r.h.		CO ₂ / r.h. / T
CO ₂		r.h.	T	¹⁾ AQR2546...	+	AQR2534...	CO ₂	r.h.	¹⁾	CO ₂ / r.h. / T
CO ₂ ³⁾	VOC ³⁾			AQR2548...	+	AQR2530...	CO ₂	IAQ ³⁾		IAQ ³⁾
CO ₂	VOC		T	AQR2548...	+	AQR2532...	CO ₂	T		IAQ / T
CO ₂	VOC	r.h.		AQR2548...	+	AQR2533...	CO ₂	r.h.		IAQ / r.h.
CO ₂	VOC	r.h.	T	AQR2548...	+	AQR2535...	CO ₂	r.h.		IAQ / r.h. / T
CO ₂	VOC	r.h.	T	AQR2548...	+	AQR2535...Q	CO ₂	r.h.		IAQ / r.h. / T
CO ₂	VOC	r.h.	T	¹⁾ AQR2548...	+	AQR2534...	CO ₂	r.h.	¹⁾	IAQ / r.h. / T

Unavailable measuring variables on terminals X1 / X2

1) LG-Ni1000 / NTC 10k

2) Measuring variables and error messages act on the sensor settings (see "Functions") on the relay contact

3) CO₂ and VOC measuring variables to determine room air quality (IAQ) by maximum selection

Equipment combinations

All systems and devices capable of processing the following sensor signals:

- Active sensor signals:
 - DC 0-10 V; DC 2-10 V; DC 0/2-10 V; DC 0-5 V;
 - DC 0-20 mA; DC 4-20 mA; DC 0/4-20 mA; DC 0-10 mA;
- Passive sensor signals:
 - For sensors AQR2534... (LG-Ni1000 or NTC 10k)





If sensors are used for:

- Min., max., and average calculation, or
- Enthalpy, enthalpy difference, absolute humidity and dew point calculation, in combination with the signal converter SEZ220 (data sheet N5146) recommended.

Accessories

Siemens Design frames

See "Dimensions" for design frame dimensions.

Type	Stock number	Frame designation (color)	Design frame format
AQR2510NFW	S55720-S158	DELTA line (titanium white)	CEE/VDE 80 x 80 mm 
AQR2510NHW	S55720-S159	DELTA miro (titanium white)	British Standard 90 x 90 mm 
AQR2510NGW	S55720-S160	DELTA azio (titanium white)	3 Modular 120 x 80 mm 
AQR2510NGW	S55720-S160	DELTA azio (titanium white)	UL 80 x 120 mm 

Third-party design frames

The sensor can be combined with the design frames from the following third manufacturers:

Manufacturer	Type
SIEMENS	Delta line
	Delta vita
	Delta miro
	Delta profil (with intermediate frame)
BERKER	B.1
	B.7
Feller	EDIZIOdue + PRESTIGE (with intermediate frame)
GIRA	E2
	Event
JUNG	Ap581 ALWW
	A500 (A581 WW)
	AS500 (AS 581 WW)
MERTEN	SYSTEM M

We recommend comparing the frame dimensions of third-party frames to the dimensions listed in section "Dimensions".

Functions

Temperature, passive (AQR2534)

The sensor measures the room temperature using a sensing element whose electric resistance changes as a function of the ambient air temperature. The following sensing elements are available depending on the front module (see "Type summary"):

- LG-Ni1000 or
- NTC 10k

Passive output signal on terminals B, M: Resistance values and accuracy depending on the selected sensing element (see diagram below).

Sensing elements

LG-Ni1000:

Characteristic curve:

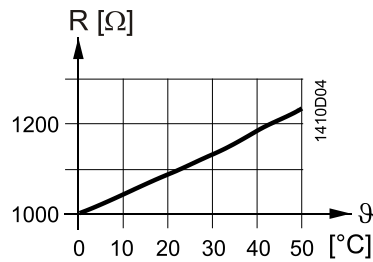

Accuracy:

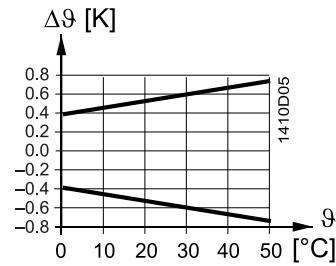

NTC 10k

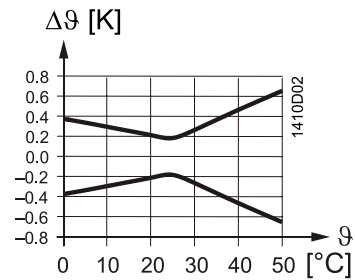
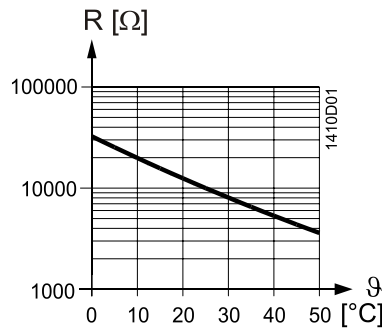

R Resistance in Ohm
 Θ Temperature in degrees Celsius
 $\Delta\Theta$ Temperature difference in Kelvin

Active sensors

The output signal of the sensors described below is provided either as linear voltage or current signal.

Output signal selection
(DIP switches 4, 5, and 6)

Select the desired output signal (size, range) as per the following table using DIP switches 4, 5, and 6 on the base module.

DIP switch symbols::

■ = Switch position left

▣ = Switch position right

DIP switches	■6	▣6
	U [V]	I [mA]
■5 ■4	0-10 V	0-20 mA
▣5 ▣4	2-10 V	4-20 mA
▣5 ■4	0/2-10 V 0 V = error message (error)	0/4-20 mA 0 mA = error message (error)
■5 ▣4	0-5 V	0-10 mA

Output signals and
measuring range

The linear output signals on output terminals X1 ¹⁾ or X2 ¹⁾ correspond to the following measuring ranges ¹⁾

Output signals / load ²⁾ :		For measuring ranges ¹⁾ :	
DC 0-10 V	at max. ±1 mA or	CO ₂ :	0-2000 ppm
DC 2-10 V	at max. ±1 mA or	VOC:	0-100 % VOC
DC 0-5 V	at max. ±1 mA or	IAQ:	0-100 % IAQ
DC 0-20 mA	at 0-500 Ohm or	r.h.:	0-100 % r.h.

DC 4-20 mA at 0-500 Ohm or DC 0-10 mA at 0-500 Ohm.	T:	0-50 °C
--	----	---------

- 1) Depending on measured variable and module combination (see "Type summary")
 2) Depending on signal selection (DIP switches 4, 5, and 6)

Temperature, active
 (AQR2532,...34,...35)²⁾

The sensor measures the room temperature using a sensing element whose electric resistance changes as a function of the ambient air temperature.

Active output signal:	For measuring range:
On terminal X2, see above for available output signals	0-50 °C

2) Depending on module combination (see "Type summary")

Relative humidity
 (AQR2533, ...34, ...35)

The sensor measures the relative humidity in the room using a humidity sensing element whose electrical capacitance changes as a function of relative humidity.

Active output signal:	For measuring range:
On terminal X1 ³⁾ or X2 ³⁾ , See above for available output signals	0-100 % r.h.

3) Depending on module combination (see "Type summary")

CO₂ concentration
 (AQR2546, AQR2548)

The sensor uses infrared absorption measurement to determine CO₂ concentration in the air (NDIR). The sensor provides exact measurements at all times and does not require maintenance or recalibration thanks to an integrated, stable reference light source.

Active output signal:	For measuring range:
On terminal X1, see above for available output signals	0-2000 ppm.

Air quality indication



(AQR2535...Q)

The background-lit symbol informs on the current level of CO₂ in the room. The colors **green** / **orange** / **red** of the background lighting indicate **good** / **mediocre** / **poor** air quality. The air quality indicator light on green signalises a concentration of ≤1000 ppm, orange ≤1500 ppm, and red exceeding 1500 ppm.

VOC concentration
 (AQR2547)

The sensor determines the mixed gas concentration (VOC) based on a metal-oxide semiconductor sensing element. The sensor provides exact measurements following a warm-up period and does not require maintenance or recalibration thanks to an integrated compensation mechanism.

Active output signal:	For measuring range:
On terminal X1, see above for available output signals	0-100 % VOC.

Room air quality (IAQ)
 (AQR2548 + AQR 2530)

The sensor measures CO₂ and VOC concentrations in the air. The greater of the two demand signals (maximum select) is provided as air quality demand (IAQ) for a ventilation controller.

Active output signal:	For measuring range:
On terminal X2, see above for available output signals	0-100 % IAQ.

Ventilation demand characteristic curve diagram (output X2)

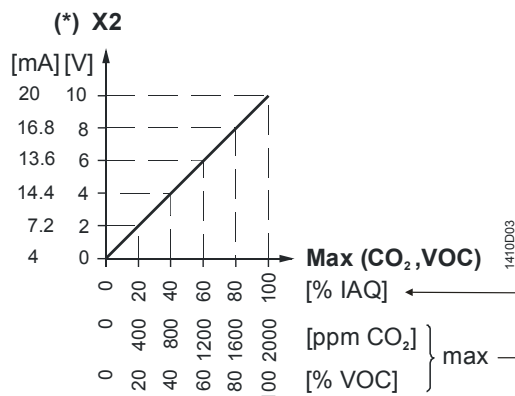

(*) Sample measuring ranges 4...20 mA and 0...10 V



Potential-free relay contact

A potential-free relay contact on the base module (connection terminals C and DO) switches in dependence of selected measuring variable, switching characteristic, and switching setpoint.

- Maximum load of relay contacts: AC/DC 30 V, 0.5 A cos φ = 0.5.
- The switching circuit is fused externally (≤ 1 A); there is no internal fuse in the device.

Measured value selection (DIP switches 1 and 2)







DIP switches 1 and 2 help determine the measured value acting on the relay. Measured variables T, r.h., or CO₂/VOC/IAQ are provided depending on the sensor module (see "Type summary" and "Mechanical design").

Measured variables	T	r.h.	CO ₂ /VOC/IAQ ⁶⁾
DIP switches 1 and 2			

6) Depending on the sensor module

Switching characteristic selection (DIP switch 3)

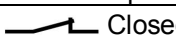
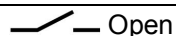
Use DIP switch 3 to determine the switching characteristic (NO or NC) for the relay contact.

		
Measured value < Switching setpoint	 Open	 Closed
Measured value > Switching setpoint	 Closed	 Open
for missing measured value	 Open	 Closed

Switching hysteresis

The adjustable switching setpoint is located in the center of the switching hysteresis:

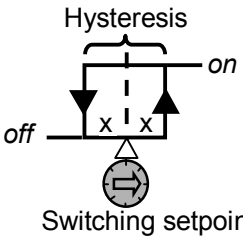

Switching setpoint

Measured variable	Hysteresis	X
CO ₂	150 ppm	75 ppm
VOC	7.5 %	3.75 %
IAQ	7.5 %	3.75 %
r.h.	5 %	2.5 %
T	2.5 K	1.25 K

Read sample:

Effective switching value = set switching setpoint



- minus "x" for switch-off point (off) or
- plus "x" for switch-on point (on).

Select relay-switching setpoint (rotary selection switch)

		Rotary selection switch position base module									ppm
		1	2	3	4	5	6	7	8	9	
Switching setpoints of measured variables	CO₂	800	900	1000	1100	1200	1300	1400	1500	1600	
	VOC	40	45	50	55	60	65	70	75	80	%VOC
	IAQ	40	45	50	55	60	65	70	75	80	%IAQ
	r.h.	10	20	30	40	50	60	70	80	90	%r.h.
	T	5	10	15	20	25	30	35	40	45	°C

Auxiliary functions
(DIP switches 1 and 2 and rotary selection switch)

DIP switches 1 and 2 and the rotary selection switch allow for implementing the following auxiliary functions:

Auxiliary functions	Rotary selection switch positions	DIP switches 1 and 2
Reset function (Reset 10s)	9 (*)	
Test function	8	
Fault signaling function (Error)	6	
Auxiliary functions off (Off)	0	

(*) Switch position 9 for at least 10 seconds.

**Reset function
(Reset)**

Rotary selection switch on position 9 for at least 10 seconds:
When the front and base modules are assembled during commissioning, the sensor outputs (X1, X2) on the base module automatically assume the active measured values from the existing module types.

Set the rotary selection switch to the ready to operate base module to position 9 for at least 10 seconds to reset the base module to default (factory setting).

Note: Reposition the rotary selection switch from position 9 to the previously set position after activating the reset function. This is the only way to assume new measured variables on the sensor outputs when re-attaching the front module on the base module.

Test function



Rotary selection switch on position 8:
The test function provides a test signal on the base module on sensor outputs (X1, X2) to check the sensor function.
The following test signals are provided as per the available sensing elements on the base module:
CO₂ concentration: 400 ppm
VOC concentration: 30%
Room air quality IAQ: 40 %
Relative humidity: 50 %
Temperature: 30 °C

**Fault signal function
(Error)**

Rotary selection switch on position 6:
The relay contact on the base module (connection terminals C and DO) is activated as soon as an error from a sensor is signaled (e.g. in case of a missing or defective sensing element).

Notes:

- The fault signaling function does not monitor a passive temperature sensor (e.g. LG-Ni1000).
- The switching function can be inverted using DIP switch 3.

 3	3 
NO contact NO (normally open)	NC contact NC (normally closed)

Response to errors

The following fault signal is indicated at the associated active sensor output (X1, X2) as soon as a fault occurs (within 10 s) on a sensor module:

<i>Selected, active output signal:</i>	<i>Fault indication signal on defective, active measured value output:</i>	
DC 0/2-10V or DC 0/4-20mA	0 V 0 mA.	
	<i>For T-sensors: Min. value</i>	<i>For r.h./CO₂/VOC sensors: Max. value</i>
DC 0-10 V	0 V	10 V
DC 2-10 V	2 V	10 V
DC 0-5 V	0 V	5 V
DC 0-20 mA	0 mA	20 mA
DC 4-20 mA	4 mA	20 mA
DC 0-10 mA	0 mA	10 mA

Design

The device is designed for flush-mounting. Run the cables from the wall outlet to the sensor base module.

The mounted device consists of:

- One base module with snapped-on mounting plate
- One design frame (ordered as separate accessory) and
- One front module.

The sensing elements are located in either the basic or the front module (see "Type summary").

Anti-theft device

Both models are connected via snap-on device and anti-theft device (red security plug) and can be easily be detached. Use a screwdriver to easily unlock the anti-theft device. Red security plug is including with the front module.

Setting and connecting elements

The setting elements DIP switch and rotary selection switch as well as the printed setting aids are available on the base module after removing the front module. See "Functions" for setting variants and their impact on sensor functions.

Printed setting aids

Setting elements

Signal variable [V] or [mA] (DIP switch 6)

Output signal (DIP switches 4 and 5)

Relay contact switching characteristic (DIP switch 3)

Auxiliary functions (DIP switches 1 and 2 rotary selector switch 0-9)

Relay constant measured variable (DIP switch 1 and 2) and switching setpoint (rotary selection switch)

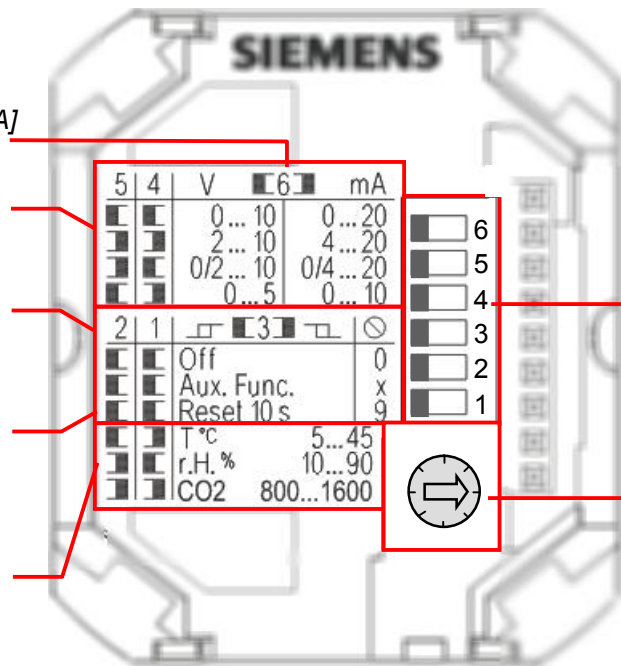

DIP switch symbols:
 = Switch position left.
 = Switch position right.

DIP switches 1 - 6.

Rotary selection switch (switch positions 0-9)

Measuring circuits and connection terminals (see "Connection terminals") are located on the base module in addition to the setting elements.

Engineering notes

Measuring accuracy

Measuring accuracy among other factors depends on the following:

- Prevailing air flow
- Wall surfaces (rough, smooth)
- Wall texture (wood, plaster, concrete, brick)
- Wall type (interior, exterior)





See also "Mounting notes".

Measuring inaccuracies are constant for an installed sensor after approx. 1 operating hour.

They can be adjusted as needed in a higher system (e.g. on the controller).

Adjustment Own heating

- No measured value adjustment is required on the controller for active temperature sensors due to own heating.
- The following adjustments of measured values on the controller are required for passive temperature sensors to compensate for own heating depending on the output signal and number of signal outputs:

Sensor modules					Measured value adjustment on controller					
					Module types (ASN)			Voltage output	Current output	
Base module	Front module				Base module	+	Front module	1 or 2	1 output ^{*)}	2 outputs ^{*)}
		r.h.	T		AQR2540...	+	AQR2534...	0.5 °C	ca. 0.9 °C	1.0-1.8 °C ^{**)}
	VOC	r.h.	T		AQR2547...	+	AQR2534...	2.9 °C	2.7-3.1 °C ^{**)}	3.0-3.8 °C ^{**)}
CO ₂		r.h.	T		AQR2546...	+	AQR2534...	0.9 °C	ca. 1.3 °C	1.4-2.1 °C ^{**)}
CO ₂	VOC	r.h.	T		AQR2548...	+	AQR2534...	3.0 °C	3.0-3.4 °C ^{**)}	3.2-3.9 °C ^{**)}

^{*)} At load 430 Ohm.

^{**)} not recommended (for physical reasons).

Power

A transformer for safety extra-low voltage SELV with separate windings, suited for 100% duty, powers the sensor. Size and fuse the transformer in compliance with local safety regulations.

When sizing the transformer, consider the power consumption of the sensor. The data sheets for the devices with which the sensor is wired provide information on how to connect the sensor.

Observe maximum permissible cable lengths.

Cable routing and cable selection

When laying the cables, remember that electrical interference increases with longer, parallel cable runs and smaller distances between cables. Use screened cables for applications in environments exposed to severe electromagnetic interference. Use twisted pair cables for secondary power lines and signal lines.

Longer transmission lines between sensor and signal-processing device can result in measured value deviations. For line impedance > 1 Ohm, we recommend to loop G0 on the device and run it separately to the signal-processing device.

Potential-free relay contact

Very high voltage peaks may occur when switching inductive loads (e.g. switching contacts) that may impact device operation. An attenuator switched parallel to the inductive load (e.g. RC element) prevents this.

The present existing switching state remains for a drop off of voltage. As a result, the relay contact cannot be used to monitor voltage.

Mounting notes

Observe the following points when mounting the room sensor:

Mounting location

Sensor mounted on interior wall of room to be conditioned:

- At ca. 1.5 m height in the room and at least 50 cm from the next wall.
- Not on outside walls.
- Not in niches or behind curtains.
- Not above or near heat sources or shelves.
- Not on walls covering heat sources such as a chimney.
- Not in the radiation range of heat sources and lighting bodies e.g. spotlights.
- Not in areas exposed to direct solar radiation.

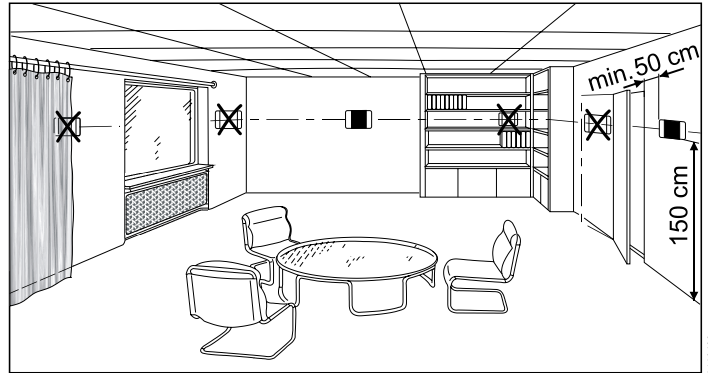

Seal the end of the installation conduit to prevent false measurements due to air drafts.

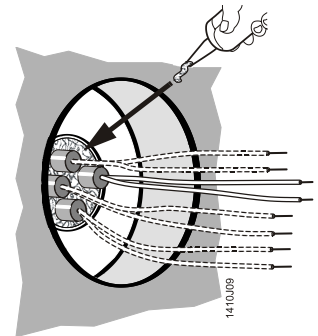

Comply with the various regulations on separating various voltage levels, when mounting the temperature sensor (with low voltage protection) alongside the recessed conduit boxes connected to the low-voltage power. In this case, the mounting frames must be connected to the protective ground wire with a flat plug connector plug and therefore grounded.

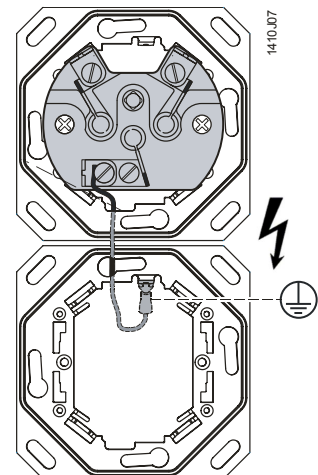

Observe the permissible ambient climate (see "Technical data").

Mounting instructions

Mounting instructions are enclosed in the device package.

See the following guideline for more information on mounting the sensor: "Symaro Sensor Installation Guide" Z-F01040501EN.

Commissioning notes

Recommended commissioning procedure:

- Check the wiring prior to supplying power.
- Set the desired voltage or current output signal using DIP switches, 4, 5, and 6 (see section "Functions", "Output signal selection").
- Briefly plug in the front module on the base module and remove. As a result, the sensor outputs (X1, X2) on the base module also take over the active measured variables of the existing module types (see also "Functions", "Reset function").
- Activate the test function on position 8 using the rotary selection switch. A test signal is provided on sensor outputs (X1, X2) to test the sensor functions (see "Functions", "Test function").
- Deactivate the test function as well as an other auxiliary function using DIP switches 1 to 3 as needed, and activate using the rotary selection switch (see "Functions", "Auxiliary functions").
- Install anti-theft protection (red security plug) on the base module as needed.
- Mount the design frame on the mounting plate on the base module and plug in the front module.

Disposal



The devices are considered electronics devices for disposal in terms of European Directive 2012/19/EU and may not be disposed of as domestic waste.

- Dispose of the device via the channels provided for this purpose.
- Comply with all local and currently applicable laws and regulations.

Warranty

Technical data on specific applications are valid only together with Siemens products listed under "Equipment combinations". Siemens rejects any and all warranties in the event that third-party products are used.

Technical data

Power	Operational voltage	AC 24 V \pm 20 % or DC 15...35 V (SELV)	
	Frequency	50/60 Hz at AC 24 V	
	External supply line protection (EU)	Fuse slow max. 10 A	
		or Circuit breaker max. 13 A Characteristic B, C, D according to EN 60898	
		or Power source with current limitation of max. 10 A	
Total power consumption (front and base module)	At "U" output signal:	"I" output signal:	
	Devices without VOC (AQR2540N..., AQR2546N...)	< 0.5 VA	< 1.5 VA
	Devices with VOC (AQR2547N..., AQR2548N...)	< 1.5 VA	< 2.5 VA
Potential-free relay contact	Relay type	Bistable	
	Max. switching voltage / Max. nominal current	AC/DC 30 V, 0.5 A $\cos \varphi = 0.5$	
	Fuse	external, max. 1 A (slow)	
Response on voltage failure	No change of state.		
Line length for measuring sign.	Permissible line length	See data sheet of the signal processing device	
Function data CO ₂ (AQR2546, AQR2548)	Measuring range	0-2000 ppm.	
	Measuring accuracy at 23 °C and 1013 hPa	$\leq \pm$ (50 ppm + 2 % of measured value).	
	Temperature dependency	± 2 ppm / °C (typically)	
	Pressure dependency	0,14 % of measured value / hPa	
	Long-term drift	$\leq \pm 5\%$ of measuring range / 5 years (typically)	
	Time constant t_{63}	< 5 min	
	Active output signal, connection X1	Select output signal: See "Functions".	
	Potential-free relay contact, connections: C and DO	Switching setpoint selection: See "Functions"	
	Recalibration-free	For at least 8 years	
	Measuring range	0-100 % VOC.	
Function data VOC (AQR2547)	Note on measuring accuracy (see also "Engineering notes")	Warm-up time: ca. 20 minutes Initial self-acting calibration after 8 hours operation	
	Time constant t_{63} VOC	< 3.5 min	
	Active output signal, connection X1	Select output signal: See "Functions".	
	Potential-free relay contact, connections: C and DO	Switching setpoint selection: See "Functions"	
Functional data (IAQ) (AQR2548 + AQR 2530)	Measuring range	Max. selection from CO ₂ and VOC Weighting: 100 % VOC $\hat{=}$ 2000 ppm CO ₂	
	Active output signal, connection X2	Select output signal: See "Functions".	
	Potential-free relay contact, connections: C and DO	Switching setpoint selection: See "Functions"	
	Measuring range	0-100 % r.h.	
Function data r.h. (AQR2533, ...34, ...35)	Field of use	0-95 % r.h. (non-condensing)	
	Measuring accuracy at 25 °C	20-80 % r.h.	± 3 % r.h.
		0-95 % r.h.	± 5 % r.h. (typically)
	Time constant	20 s	
	Active output signal, connection X1 or X2 depending on module type (see "Type summary")	Select output signal: See "Functions".	
	Potential-free relay contact, connections: C and DO	Switching setpoint selection: See "Functions"	
	Measuring range	0-50 °C	
Function data temperature active (AQR2532, ...34 ¹⁾ , 35 ¹⁾)	Measuring accuracy at AC 24 V for	25 °C	$\leq \pm 0.25$ K (temperature sensor, typically)
		5-30 °C	$\leq \pm 0.5$ K (at output signal 0...10 V)
			$\leq \pm 0.6$ K (at output signal 4...20 mA)
	Time constant t_{63}	Ca. 13 min	
	Active output signal, connection X2	Select output signal: See "Functions".	
Function data temperature passive (AQR2534)	Potential-free relay contact, connections: C and DO	Switching setpoint selection: See "Functions"	
	Sensing elements	Depending on front module (see "Type summary") NTC 10k (B=3988) or LG-Ni1000.	
	Measuring range	0-50 °C (detailed data see "Functions")	
	Time constant t_{63}	Ca. 13 min	
	Adjustment for own heating	See "Engineering notes".	
	Output signal (terminals B, M)	Passive	

Degree of protection	Protection degree of housing	IP30 with front module IP20 without front module according to EN 60529
	Protection class	III according to EN 60730-1
Electrical connection	Screw terminals for	1 × 0.25...2.5 mm ² (wire / strand) 2 × 0.25...1.5 mm ² (wire / strand)
	Environmental conditions	Operation as per Climatic conditions Temperature (housing and electronics) Humidity Mechanical conditions
		IEC 60721-3-3 Class 3K3 0-50 °C 0-95% r. h. (non-condensing) Class 3M2.
	Transport as per Climatic conditions Temperature Humidity Mechanical conditions	IEC 60721-3-2 Class 2K3 -25...+70 °C <95 % r.h. Class 2M2
Materials and colors	Top part of front module	ASA + PC titan white (similar to RAL9010).
	Lower part of front module	PC light-gray RAL 7035
	Housing parts of base module	PC light-gray RAL 7035.
	Anti-theft device	POM bright red RAL 3000.
	Siemens Design frames	ASA + PC titan white (similar to RAL9010).
	Mounting plate	Steel
	Sensor, total	Silicone-free
	Packaging	Corrugated cardboard
Directives and Standards	Product standard	EN 60730-1 Automatic electrical controls for household and similar use
	Electromagnetic compatibility (Applications)	For use in residential, commerce, light-industrial and industrial environments
	EU Conformity (CE)	CE1T1410xx ²⁾
	RCM Conformity	CE1T1410en_C1 ²⁾
Environmental compatibility	The product environmental declaration CE1E1410 ²⁾ contains data on environmentally compatible product design and assessments (RoHS compliance, materials composition, packaging, environmental benefit, disposal).	
Dimensions (weight)	Including packaging, depending on the module type	
	Front module	between 30 – 50 g
	Base module	between 60 – 100 g.

1) Possible module combination, see "Type summary".

2) The documents can be downloaded from <http://siemens.com/bt/download>.

Connection terminals

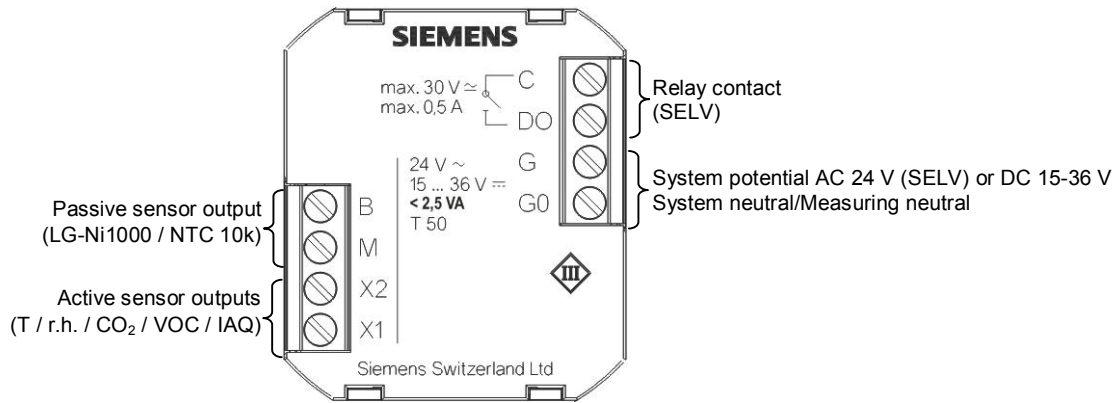

Dimensions (in mm)

Base module

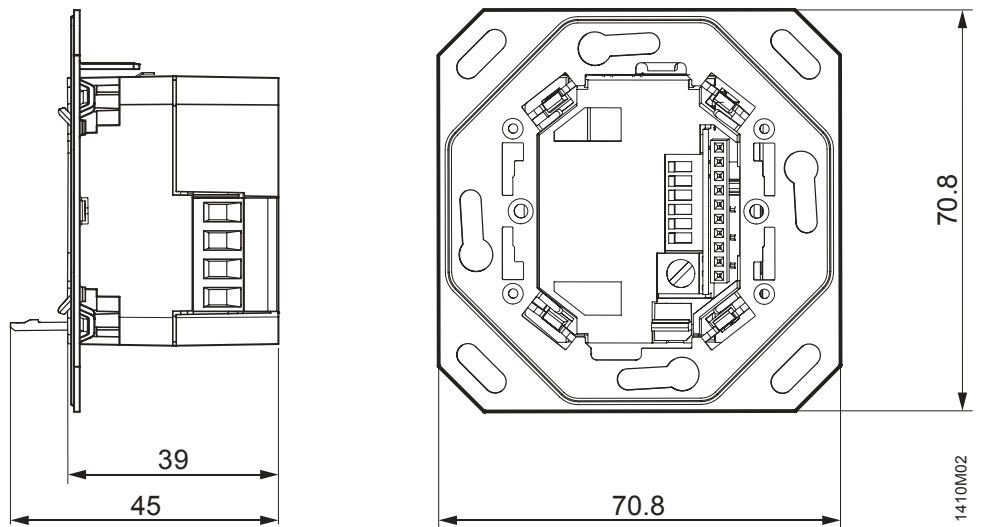

Front and base module (assembled without design frame)

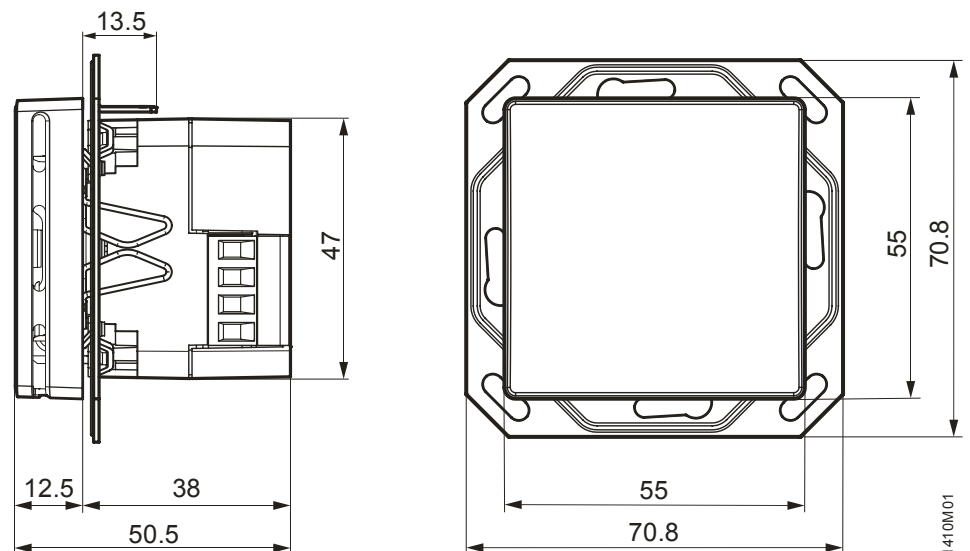

Mounting plate and design frame

Mounting plate "CEE/VDE" (square):

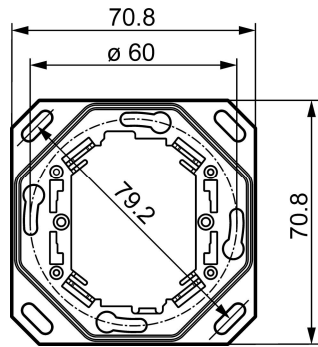

DELTA line design frame:

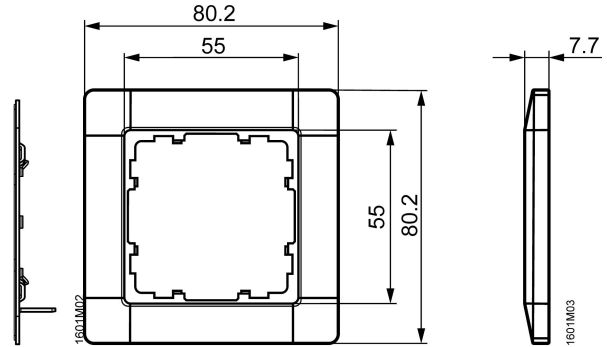

Mounting plate "British standard" (square):

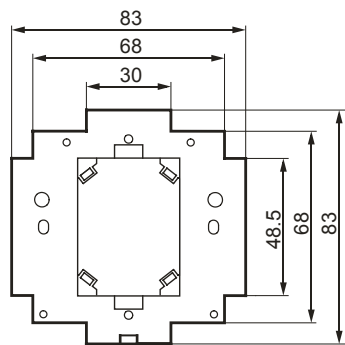

DELTA miro design frame:

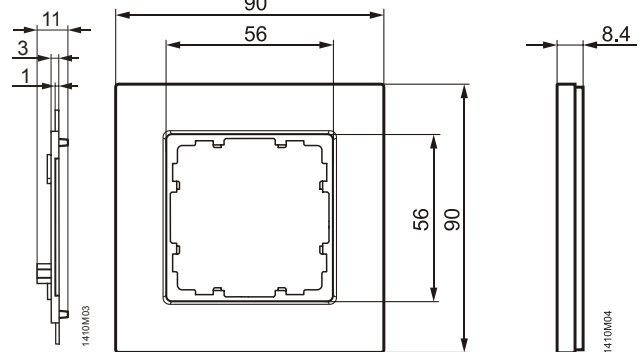

Mounting plate "3 Modular" (landscape):

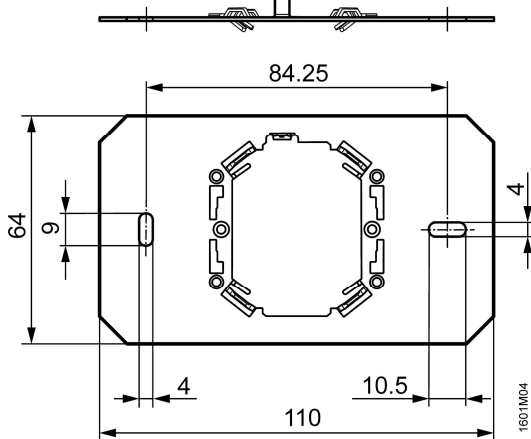

Design frames "DELTA azio":

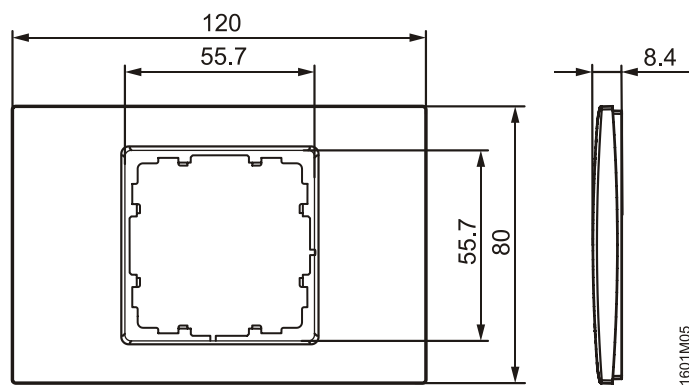

Mounting plate "UL" (portrait):
Dimensions same as for mounting plate "3 Modular" (see above), but portrait format

Design frame "DELTA azio":
Dimensions same as for design frame "DELTA azio" (see above), but portrait format

Issued by
Siemens Switzerland Ltd
Building Technologies Division
International Headquarters
Gubelstrasse 22
6301 Zug
Switzerland
Tel. +41 41-724 24 24
www.siemens.com/buildingtechnologies

© Siemens Switzerland Ltd, 2011
Technical specifications and availability subject to change without notice.