

SIEMENS

SiPass integrated Dual Reader Interface Module (ADD5100)

Installation Manual

Fire Safety & Security Products

Siemens Building Technologies

Liefermöglichkeiten und technische Änderungen vorbehalten.
Data and design subject to change without notice. Supply subject to availability.
© 2005 Copyright by
Siemens Building Technologies AG

Wir behalten uns alle Rechte an diesem Dokument und an dem in ihm dargestellten Gegenstand vor. Der Empfänger anerkennt diese Rechte und wird dieses Dokument nicht ohne unsere vorgängige schriftliche Ermächtigung ganz oder teilweise Dritten zugänglich machen oder außerhalb des Zweckes verwenden, zu dem es ihm übergeben worden ist.

We reserve all rights in this document and in the subject thereof. By acceptance of the document the recipient acknowledges these rights and undertakes not to publish the document nor the subject thereof in full or in part, nor to make them available to any third party without our prior express written authorization, nor to use it for any purpose other than for which it was delivered to him.

Contents

1	Dual Reader Interface Module (ADD5100)	5
1.1	Product Description	5
1.2	Product Numbers	5
1.3	Prerequisites	5
1.4	Required Tools & Material	6
1.5	Expected Installation Time	6
1.6	Mounting Instructions	6
1.7	Wiring	7
1.8	Reader Wiring	10
1.9	Links and Jumpers	10
1.10	Supported Card Formats	12
1.11	LEDs	12
1.12	Recommended Cable Specifications	13
1.13	Programming and Firmware Download	13

1 Dual Reader Interface Module (ADD5100)

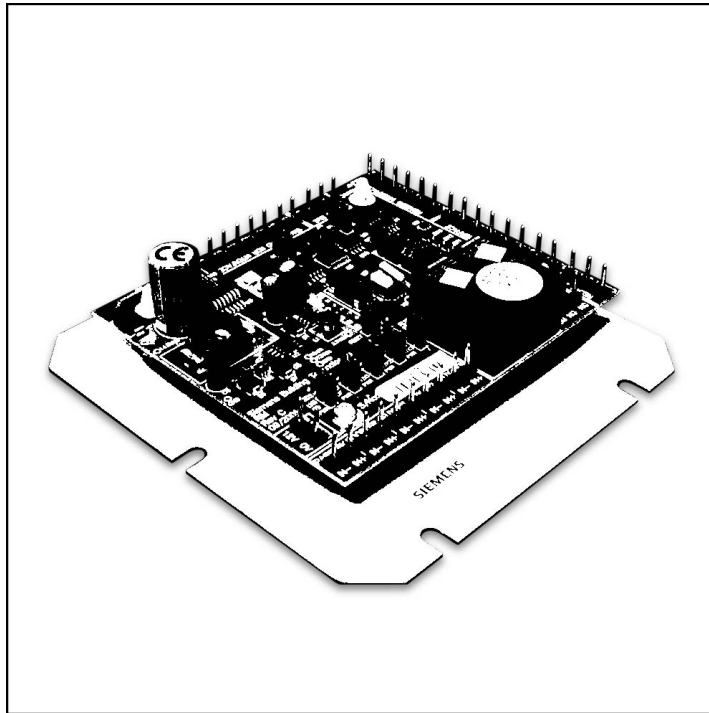

Fig. 1 Dual Reader Interface Module (ADD5100)

1.1 Product Description

The ADD5100 is a Reader Interface Module used as part of a Siemens integrated access control and security solution. It provides an interface between an Advanced Access Controller (ACC), up to 2 card readers and other devices used to secure and monitor a door.

When a cardholder presents their access card at a reader (connected to a ADD5100) the ADD5100 interprets the encoded information and sends this data to the ACC. The ACC then checks their validity. If the appropriate permissions have been assigned to the cardholder, the ACC then sends a message back to the ADD5100 allowing it to unlock the door and permit access.

1.2 Product Numbers

6FL7820-8CA10 ADD5100 – Dual Reader Interface Module and base-plate,
24 V DC

1.3 Prerequisites

- Devices to be connected to the ADD5100.
- Cabling (RS485)

1.4 Required Tools & Material

- Medium-duty drill and associated drill-bits (if required)
- 4 to 6 mounting screws or standoffs (approx. 4mm)
- Flat-blade terminal screwdriver
- Wire cutters
- Cable strippers

1.5 Expected Installation Time

30 minutes

1.6 Mounting Instructions

1. Remove the ADD5100 from its carton and discard the packaging material.
2. Place the ADD5100 (base-plate) against the surface to which it is to be affixed and mark the location of the mounting holes.
If being mounted within a cabinet, simply align the ADD5100 base-plate with the holes located on the cabinet backplane and proceed to step 3.
It is recommended that you affix the ADD5100 in at least four of the six mounting locations.



WARNING

Do not apply power to the ADD5100 or associated components at this stage.

3. Select the appropriate drill bit according to the mounting surface / hole size and drill the holes in the locations marked (if required).
4. Fasten the ADD5100 (base-plate) to the surface using the correct type of screws or standoffs for the surface.
5. Connect the cabling to the ADD5100 PCB (as described in the next section titled 'Wiring').
6. Apply power to the ADD5100 and test its operation.
This step may require installation and programming of the access control host software.
The firmware and configuration carried out using the FLN Field Service Tool.

1.7 Wiring

→ It is recommended that you wear a grounding strap while carrying out this procedure.

1. Connect an IN reader to the **READER1 INTERFACE** port an OUT reader to the **READER2 INTERFACE** port if the ADD5100 has been configured to operate as a Dual Reader Interface.
or
Connect the RS232 or RS485 output readers to the SMARTCARD RDR INTERFACE port.
-



The readers must be wired correctly as outlined in the Reader Wiring tables in this installation sheet.

2. Connect the Request to Exit (REX) switch to the **REX** port.
 3. Connect the door contact device to the **DOOR/C** port.
 4. Connect auxiliary inputs (if required) to the **AUX IN1 / AUX IN2 / AUX IN3** ports.
-



Listed end-of-line resistors must be connected to the wires of each input device if they are to be supervised.

5. Connect the FLN wires (from the ACC) to the **RS485 BUS** port.
 6. Connect the door strike / lock to the **RELAY** port. Ensure that power is also provided to the door lock / strike, and that this power supply is sufficiently rated to handle the load.
-



If the door lock is likely to draw excess current or produce large voltage spikes a diode bridge rectifier may need to be fitted.

7. Connect the auxiliary output device (if required) to the **RELAY2** port.
8. If the FLN cable is long or subject to high noise, ensure that the jumper across link LK5 (EOL) has been made.
9. Connect the active and neutral wires from the Power Supply Unit (PSU) to the **+Vdc IN** port. Ensure the polarity of the connection is made correctly.
10. Check all connections thoroughly.
11. Power can now be applied to the ADD5100.

Dual Reader Interface Module (ADD5100)

The following diagram displays the layout and dimensions of the ADD5100.

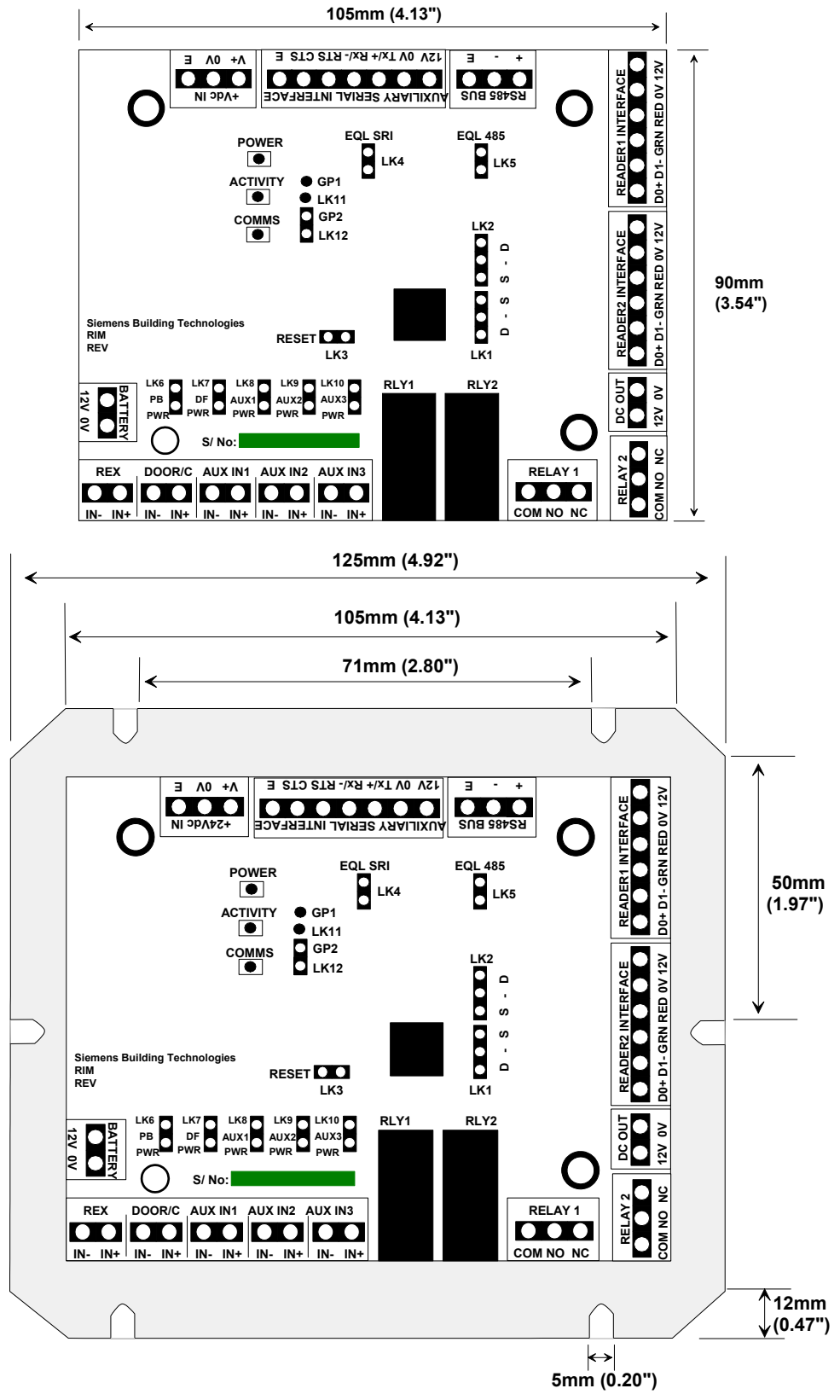

The following diagram displays the location of the ports on the ADD5100:

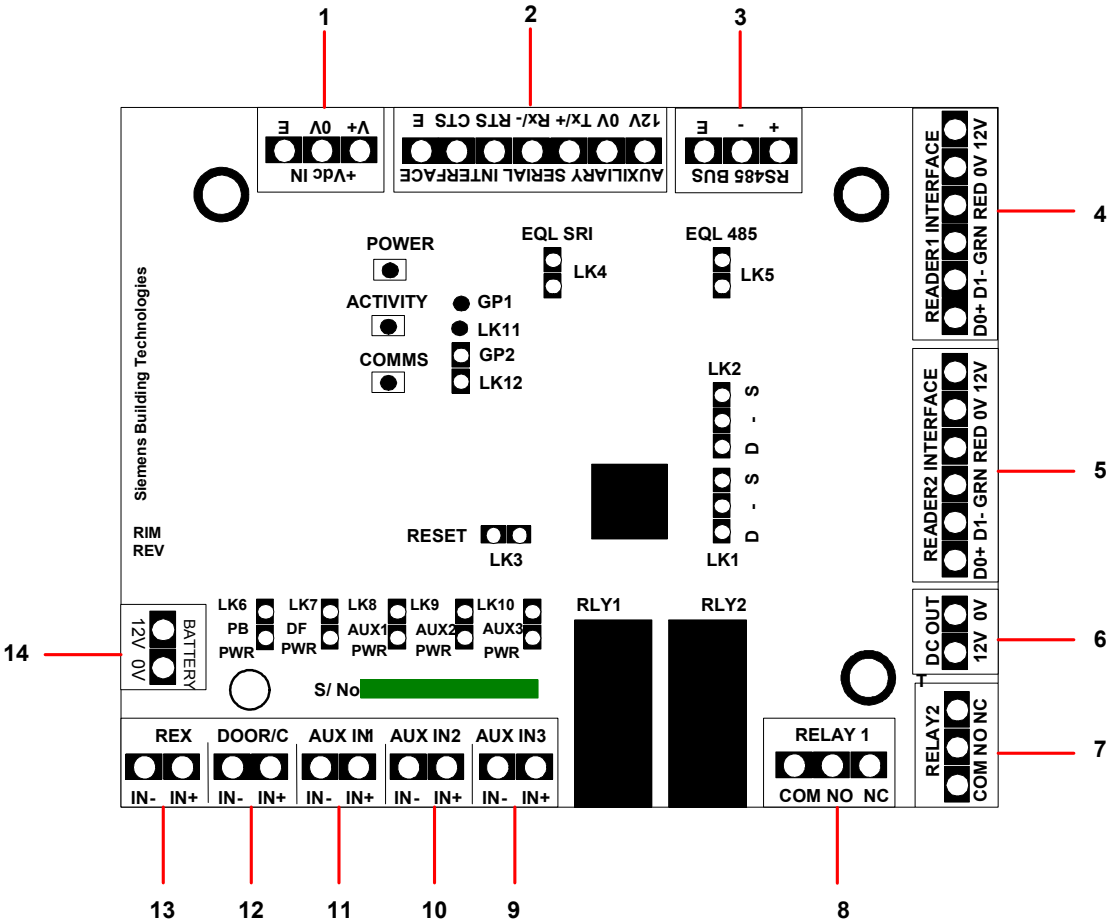

The following table provides a brief description of each port:

Port Name	Brief Description
1 +Vdc IN	24 V DC power input
2 AUXILIARY SERIAL INTERFACE	Connection for smart card or RS485 readers
3 RS485 BUS	RS485 communications port for connection to an ACC FLN channel
4 Reader Interface 1	Connection for a IN card reader providing communications, power, and LED control
5 Reader Interface 2	Connection for a OUT card reader providing communications, power, and LED control
6 DC Out	12V DC power supply
7 Relay 2	Auxiliary relay driven output
8 Relay 1	Door lock / strike relay driven output
9 AUX IN3	Auxiliary input connection 3
10 AUX IN2	Auxiliary input connection 2
11 AUX IN1	Auxiliary input connection 1
12 DOOR/C	Door contact input connection
13 REX	Request-to-Exit (REX) device connection
14 BATTERY	not supported function

1.8 Reader Wiring

The following table outlines industry standard reader wiring to the ADD5100 (Reader 1 and 2):











Reader Output Type	D0+	D1-	GRN	RED	0V	12V
Wiegand	D0	D1	GRN	RED	0V	12V
Magstripe (ABA Track II – Clock & Data)	RCP	RDP	GRN	RED	0V	8V/12V
Bar Code (Differential - Pulse)	D+	D-	GRN	RED	0V	8V/12V

The following table outlines the reader wiring to the ADD5100 for RS485 output readers:







Reader Output Type	12V	0V	TX/-	RX/+	RTS	CTS	CTS
RS485	8V/12V	0V/GND	-	+	n/a	n/a	Shield

1.9 Links and Jumpers

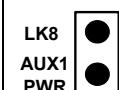
The following table outlines the link settings for the ADD5100:

Link	Description	Value	
LK1	No Link –link included for future enhancement.		
LK3	Reset This link allows the unit to be manually reset.	Normal Operation (jumper off) 	Reset – by placing the jumper across this link the unit will automatically reset. 
LK4	EOL Termination (Smart Card Reader) This link allows the SMARTCARD RD INTERFACE communications channel to be terminated in noisy or lengthy comms.	SMARTCARD RDR INTERFACE port not terminated. EOL SRI 	SMARTCARD RDR INTERFACE port terminated. EOL SRI 
LK5	EOL Termination (Bus) This link allows the RS485 BUS communications channel to be terminated in noisy or lengthy comms.	RS485 BUS port not terminated. EOL485 	RS485 BUS port terminated. EOL485 
LK6	Passback Input – Passive / Active This link allows “Passback Input” to be configured as an active or passive device.	Passive device connected (Jumper ON) LK6 PB PWR 	Active device connected (Jumper OFF) LK6 PB PWR 
LK7	Door Frame Input This link allows “Doorframe Input” to be configured as an active or passive device.	Passive device connected (Jumper ON) LK7 DF PWR 	Active device connected (Jumper OFF) LK7 DF PWR 

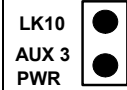
Dual Reader Interface Module (ADD5100)

Link	Description	Value	
LK8	Auxiliary Input 1 This link allows "Auxiliary 1 Input" to be configured as an active or passive device.	Passive device connected (Jumper ON) 	Active device connected (Jumper OFF) 
LK9	Auxiliary Input 2 This link allows "Auxiliary 2 Input" to be configured as an active or passive device.	Passive device connected (Jumper ON) 	Active device connected (Jumper OFF) 
LK10	Auxiliary Input 3 This link allows "Auxiliary 3 Input" to be configured as an active or passive device.	Passive device connected (Jumper ON) 	Active device connected (Jumper OFF) 
Link	Description		
LK11	Memory Clear and Reset – Short the 2 solder joints where the pins for link LK11 used to be. By shorting these joints, the ADD5100 will completely reset and the programmed memory will be cleared. Please note that the ADD5100 will need to be re-programmed for operation after a full reset.		
LK12	No Link – General Purpose link included for future enhancement.		

1.10 Supported Card Formats

The following table outlines the supported card formats for the ADD5100. Please note the formats supported will depend directly upon the firmware, which has been downloaded.

Card Technology	Format
Bar Code	2 of 5
	3 of 9
	Encrypted
	Facility
Magstripe	Credit
	Encrypted
	Facility
	CerPass
	SiPass
HID Proximity	26-bit
	36-bit Asco
	Corporate 1000
	Siemens STG (*)
	Siemens 52-bit encrypted
Indala Proximity	27 bit
Cotag Proximity	27 bit
Siemens Proximity	Encrypted
MIFARE	CSN32
	CSN40
	Sector – Siemens 52-bit
MIFARE Smart	Siemens
Asset ID Proximity	IBMAAssetID1
125 Khz Proximity	CerPass
Miro	CerPass
Hitag1	Cerpass
Hitag2	CerPass
Legic	CerPass

(*) for use in UL installations

1.11 LEDs

The following table describes the operation of the LEDs located on the ADD5100:

LED	Brief Description
POWER	The POWER led is illuminated when power has been applied to the DRI.
ACTIVITY	This LED indicates whether the initial instruction set has been downloaded. If power is applied and the LED blinks quickly, the DRI instruction set (firmware) needs to be downloaded. If the LED is blinking slowly, approximately once per second, a firmware set has already been downloaded.
COMMS	The COMMS led flashes when the DRI is communicating with the ACC to which it has been connected (via an FLN).

1.12 Recommended Cable Specifications

The following table outlines the cable recommended for connection of an integrated security system:

Communication Type	Recommended Cable Specifications							
	Core	Pairs	AWG	Stranding	Wire Type	Insulation	Shield	Jacket
RS485	4	2	28	7 x 36	Tinned Copper	Foam Polyethylene	Aluminum foil- Polyester tape / braided shield	PVC
	6	3	28	7 x 36	Tinned Copper	Foam Polyethylene	Aluminum foil- Polyester tape / braided shield	PVC
	8	4	28	7 x 36	Tinned Copper	Foam Polyethylene	Aluminum foil- Polyester tape / braided shield	PVC
RS232	4	2	24	7 x 32	Tinned Copper	Foam Polyethylene	Aluminum foil- Polyester tape / no braid	PVC
	6	3	24	7 x 32	Tinned Copper	Foam Polyethylene	Aluminum foil- Polyester tape / no braid	PVC
	8	4	24	7 x 32	Tinned Copper	Foam Polyethylene	Aluminum foil- Polyester tape / no braid	PVC
RS422	4	2	24	7 x 32	Tinned Copper	Foam Polyethylene	Aluminum foil- Polyester tape / no braid	PVC
	6	3	24	7 x 32	Tinned Copper	Foam Polyethylene	Aluminum foil- Polyester tape / no braid	PVC
	8	4	24	7 x 32	Tinned Copper	Foam Polyethylene	Aluminum foil- Polyester tape / no braid	PVC
RJ-45	8	4	24	Solid	Bare Copper	Polyethylene	Unshielded	PVC
	8	4	24	7 x 32	Tinned Copper	Polyethylene	Unshielded	PVC
RJ-12	8	4	24	Solid	Bare Copper	Polyethylene	Aluminum foil- Polyester tape / no braid	PVC
	8	4	24	7 x 32	Tinned Copper	Polyethylene	Aluminum foil- Polyester tape / no braid	PVC
Wiegand / Reader	6	3	28	7 x 36	Tinned Copper	Foam Polyethylene	Aluminum foil- Polyester tape / braided shield	PVC
Power (12/24 V DC)	2	1	18	19 x 30	Tinned Copper	Foam Polyethylene	Unshielded	PVC



The previous table provides a guideline for selecting an appropriate cable type only. Other cable types are also compatible with the system and can be used to achieve the same results.

1.13 Programming and Firmware Download

The ADD5100 is programmed using the stand-alone “Field Service Tool” application. Please refer to the respective User’s Guide for more information.



Information in this document is based on specifications believed correct at the time of publication. The right is reserved to make changes as design improvements are made.

Issued by
Siemens Building Technologies
Fire & Security Products GmbH & Co. oHG
D-76181 Karlsruhe

www.sbt.siemens.com

© 2005 Copyright by
Siemens Building Technologies AG
Data and design subject to change without notice.
Supply subject to availability.

Printed in the Federal Republic of Germany
on environment-friendly chlorine-free paper.

Document no. **A24205-A335-B246**
Edition 02.2005