



ACVATIX™

2- and 3-port valves with flanged connections, PN 25

VVF53..
VXF53..

From the large-stroke valve line

- High-performance valves for medium temperatures from -20...220 °C
- Valve body of nodular cast iron EN-GJS-400-18-LT
- DN 15...150
- k_{vs} 0.16...400 m³/h
- Flange type 21, flange design B
- VVF53..K with pressure compensation to handle high differential pressure
- Equipable with electro-motoric actuators SAX..Y or electro-hydraulic actuators SKD.., SKB.., SKC..

Use

In boiler, district heating and refrigeration plants, cooling towers, heating groups, and in air handling units as control or shutoff valves.

For use in closed or open hydraulic circuits (observe cavitation).

Type summary

Valves	Actuators				SAX..Y ⁶⁾	SKD.. ²⁾	SKB..	SKC..													
	Stroke				20 mm		40 mm														
PN 25	Positioning force				500 N	1000 N ⁷⁾	2800 N	2800 N													
PN 16 ¹⁾	Data sheet				N4515	N4561/N4560	N4664	N4566													
	Stock no.	DN	k _{vs} [m ³ /h]	S _v	Δp _s	Δp _{max}	Δp _s	Δp _{max}	Δp _s	Δp _{max}											
[kPa]																					
Fluids Preferred flow direction with fluids for low noise operation and high kvs-values with all actuator types	VVF53.15-0.16	S55208-V100	15	0.16	2200	1200	2500	1200	2500	1200	-	-									
	VVF53.15-0.2	S55208-V101	15	0.2																	
	VVF53.15-0.25	S55208-V102	15	0.25																	
	VVF53.15-0.32	S55208-V103	15	0.32																	
	VVF53.15-0.4	S55208-V104	15	0.4																	
	VVF53.15-0.5	S55208-V105	15	0.5																	
	VVF53.15-0.63	S55208-V106	15	0.63																	
	VVF53.15-0.8	S55208-V107	15	0.8																	
	VVF53.15-1	S55208-V108	15	1																	
	VVF53.15-1.25	S55208-V109	15	1.25																	
	VVF53.15-1.6	S55208-V110	15	1.6																	
	VVF53.15-2	S55208-V111	15	2																	
	VVF53.15-2.5	S55208-V112	15	2.5																	
	VVF53.15-3.2	S55208-V113	15	3.2																	
	VVF53.15-4	S55208-V114	15	4																	
	VVF53.20-6.3	S55208-V116	20	6.3	1600																
	VVF53.25-5	S55208-V117	25	5	950	900	2100	1200	1100	2000	1200	-	-								
	VVF53.25-6.3	S55208-V118	25	6.3																	
	VVF53.25-8	S55208-V119	25	8																	
	VVF53.25-10	S55208-V120	25	10																	
	VVF53.32-16	S55208-V122	32	16																	
	VVF53.40-12.5	S55208-V123	40	12.5																	
	VVF53.40-16	S55208-V124	40	16																	
	VVF53.40-20	S55208-V125	40	20																	
	VVF53.40-25	S55208-V126	40	25																	
	VVF53.50-31.5	S55208-V127	50	31.5																	
	VVF53.50-40	S55208-V128	50	40	200	150	450	400	1200	1150											
VVF53.65-63 ³⁾	S55208-V129	65	63	-	-	-	-	-	-	-	-	700	650								
VVF53.80-100 ³⁾	S55208-V130	80	100									450	400								
VVF53.100-160 ³⁾	S55208-V131	100	160									300	250								
VVF53.125-250 ³⁾	S55208-V132	125	250									175	160								
VVF53.150-400	S55208-V133	150	400									125	100								
VVF53.50-40K ³⁾	S55208-V134	50	40									2500	1200	2500	1250	2500	1250	-	-		
VVF53.65-63K ³⁾	S55208-V135	65	63									-	-	-	-	-	-	-	-	2500	1250
VVF53.80-100K ³⁾	S55208-V136	80	100																		
VVF53.100-160K ³⁾	S55208-V137	100	160																		
VVF53.125-250K ³⁾	S55208-V138	125	250																		
VVF53.150-360K	S55208-V139	150	360																		

¹⁾ DN 15...50: Flange dimensions for PN 16 and PN 25

DN 65...150: Flange dimensions only for PN 25

²⁾ Usable up to a max. medium temperature of 150 °C

³⁾ Valve characteristic for k_{vs} value 63 m³/h from 90% stroke, k_{vs} value 100, 160 and 250 m³/h from 80% stroke is optimized for maximum volumetric flow

VVF53..K: Valve characteristic for k_{vs} value 63 m³/h from 90% stroke, k_{vs} value 40, 100, 160 and 250 m³/h from 80% stroke is optimized for maximum volumetric flow

⁴⁾ Operate with opposite flow direction with steam

⁵⁾ Reduced k_{vs} value

⁶⁾ Usable up to a max. medium temperature of 100 °C

⁷⁾ SKD..SL with 800 N positioning force

DN = Nominal size

k_{vs} = Flow nominal value of cold water (5...30 °C) through the fully opened valve (H₁₀₀) at a differential pressure of 100 kPa (1 bar)

S_v = Rangeability

Δp_s = Maximum permissible differential pressure at which the motorized valve still closes securely against the pressure

Δp_{max} = Maximum permissible differential pressure across the valve's throughport for the entire positioning range of the motorized valve

Valves	Actuators				SAX..Y ⁶⁾	SKD.. ²⁾	SKB..	SKC..																			
	Stroke				20 mm																						
	Positioning force				500 N	1000 N ⁷⁾	2800 N	2800 N																			
	Data sheet				N4515	N4561/N4560	N4664	N4566																			
PN 25 PN 16 ¹⁾	Stock no.	DN	k _{vs} [m ³ /h]	S _v	Δp _s	Δp _{max}	Δp _s	Δp _{max}	Δp _s	Δp _{max}																	
					[kPa]																						
Steam ⁴⁾ Exclusive flow direction for steam. Also useful for maximum close-off pressure Δp _s and maximum differential pressure in operation (Δp _{max}) with fluids. Use with electro-hydraulic actuators only	VVF53.15-0.16	S55208-V100	15	0.16	> 50			1200																			
	VVF53.15-0.2	S55208-V101	15	0.2																							
	VVF53.15-0.25	S55208-V102	15	0.25																							
	VVF53.15-0.32	S55208-V103	15	0.32																							
	VVF53.15-0.4	S55208-V104	15	0.4																							
	VVF53.15-0.5	S55208-V105	15	0.5																							
	VVF53.15-0.63	S55208-V106	15	0.63																							
	VVF53.15-0.8	S55208-V107	15	0.8																							
	VVF53.15-1	S55208-V108	15	1																							
	VVF53.15-1.25	S55208-V109	15	1.25																							
	VVF53.15-1.6	S55208-V110	15	1.6																							
	VVF53.15-2	S55208-V111	15	2																							
	VVF53.15-2.5	S55208-V112	15	2.5																							
	VVF53.15-3.2	S55208-V113	15	3.2																							
	VVF53.15-4 ⁵⁾	S55208-V114	15	3.6																							
	VVF53.20-6.3 ⁵⁾	S55208-V116	20	5																							
	VVF53.25-5	S55208-V117	25	5																							
	VVF53.25-6.3	S55208-V118	25	6.3																							
	VVF53.25-8	S55208-V119	25	8																							
	VVF53.25-10 ⁵⁾	S55208-V120	25	8																							
	VVF53.32-16 ⁵⁾	S55208-V122	32	15																							
	VVF53.40-12.5	S55208-V123	40	12.5																							
	VVF53.40-16	S55208-V124	40	16																							
	VVF53.40-20	S55208-V125	40	20																							
	VVF53.40-25 ⁵⁾	S55208-V126	40	23																							
VVF53.50-31.5	S55208-V127	50	31.5																								
VVF53.50-40	S55208-V128	50	40																								
VVF53.65-63	S55208-V129	65	63																								
VVF53.80-100	S55208-V130	80	100																								
VVF53.100-160 ⁵⁾	S55208-V131	100	150																								
VVF53.125-250 ⁵⁾	S55208-V132	125	220																								
VVF53.150-400 ⁵⁾	S55208-V133	150	360																								
Steam ⁴⁾ Exclusive flow direction for steam.	VVF53.50-40K ³⁾	S55208-V134	50	36	> 100			25000	1250	2500	1250	-	-														
	VVF53.65-63K ³⁾	S55208-V135	65	63																							
	VVF53.80-100K ³⁾	S55208-V136	80	100																							
	VVF53.100-160K ³⁾	S55208-V137	100	150																							
	VVF53.125-250K ³⁾	S55208-V138	125	220																							
	VVF53.150-360K	S55208-V139	150	315																							
Fluids	VXF53.15-1.6	S55208-V140	15	1.6	> 100			1200	200	1200	200	1200	200	-	-												
	VXF53.15-2.5	S55208-V141	15	2.5																							
	VXF53.15-4	S55208-V142	15	4																							
	VXF53.20-6.3	S55208-V144	20	6.3																							
	VXF53.25-6.3	S55208-V145	25	6.3																							
	VXF53.25-10	S55208-V146	25	10																							
	VXF53.32-16	S55208-V148	32	16																							
	VXF53.40-16	S55208-V149	40	16																							
	VXF53.40-25	S55208-V150	40	25																							
	VXF53.50-40	S55208-V152	50	40																							
	VXF53.65-63 ³⁾	S55208-V153	65	63																							
	VXF53.80-100 ³⁾	S55208-V154	80	100																							
	VXF53.100-160 ³⁾	S55208-V155	100	160																							
	VXF53.125-250 ³⁾	S55208-V156	125	250																							
	VXF53.150-400	S55208-V157	150	400																							

Note

When using a stem heating element with a medium temperature of below $-5\text{ }^{\circ}\text{C}$, the stem sealing gland must be replaced. In this case, the sealing gland must be ordered separately (Stock number: 4 284 8806 0).

Ordering**Example**

Product number	Stock number	Description
VXF53.25-6.3	S55208-V145	3-port valve with flange, PN 25
SKB32.51	BPZ:SKB32.51	Electro-hydraulic actuator

Delivery

Valves, actuators and accessories are packed and delivered as separate items.

Note

Counter-flanges, bolts and gaskets must be provided on site.

Spare parts, Rev.-Nr.

See page 14

Equipment combinations

Product number	Description	Stroke	Positioning force	Operating voltage	Positioning signal	Spring return time	Positioning time	LED	Manual adjuster	Auxiliary functions								
SAX31.00Y	S55150-A105-A998	20 mm	500 N	AC 230 V	3-position	-	120 s	-	Push and fix	1) 2), 3)								
SAX31.03Y	S55150-A106-A998						30 s											
SAX61.03Y	S55150-A100-A998			AC/DC 24 V	3-position		0...10 V 4...20 mA 0...1000 Ω				120 s							
SAX81.00Y	S55150-A102-A998						30 s											
SAX81.03Y	S55150-A103-A998						30 s											
SKD32.21..		20 mm	1000 N ⁵⁾	AC 230 V	3-position	-	8 s	-	Turn, Position is maintained	1) 2) 4)								
SKD32.50..							120 s											
SKD32.51	SKD32.51						8 s											
SKD60..				AC 24 V	0...10 V 4...20 mA 0...1000 Ω		15 s				Opening: 30 s Closing: 15 s							
SKD62	SKD62						3-position				-	120 s						
SKD62U	SKD62U																	
SKD62UA	SKD62UA						8 s											
SKD82.50..				20 mm	2800 N		AC 230 V				3-position	-	120 s	-	Turn, Position is maintained	1) 2) 4)		
SKD82.50U	SKD82.50U												10 s					
SKD82.51	SKD82.51												10 s					
SKD82.51U	SKD82.51U	10 s																
SKB32.50	SKB32.50	40 mm	2800 N			AC 24 V	0...10 V 4...20 mA 0...1000 Ω	20 s	Opening: 120 s Closing: 10 s									
SKB32.51	SKB32.51							3-position	-	120 s								
SKB60	SKB60										10 s							
SKB62	SKB62			AC 230 V	3-position	-	120 s											
SKB62U	SKB62U																	
SKB62UA	SKB62UA																	
SKB82.50	SKB82.50																	
SKB82.50U	SKB82.50U	40 mm	2800 N	AC 24 V	0...10 V 4...20 mA 0...1000 Ω	-	120 s	-	Turn, Position is maintained	1) 2) 4)								
SKB82.51	SKB82.51						3-position				-	120 s						
SKB82.51U	SKB82.51U																	
SKC32.60	SKC32.60			40 mm	2800 N		AC 230 V				3-position	-	120 s	-	Turn, Position is maintained	1) 2) 4)		
SKC32.61	SKC32.61												AC 24 V				0...10 V 4...20 mA 0...1000 Ω	18 s
SKC60	SKC60																	3-position
SKC62	SKC62	AC 230 V	3-position			-	120 s											
SKC62U	SKC62U																	
SKC62UA	SKC62UA	18 s																
SKC82.60	SKC82.60	AC 24 V	0...10 V 4...20 mA 0...1000 Ω	3-position	-	120 s												
SKC82.60U	SKC82.60U																	
SKC82.61	SKC82.61	AC 230 V	3-position	-	120 s													
SKC82.61U	SKC82.61U																	

¹⁾ Auxiliary switch, potentiometer

²⁾ Position feedback, forced control, selection of valve characteristic

³⁾ Optional: Sequence control, selection of acting direction

⁴⁾ Plus sequence control, stroke limitation, and selection of acting direction

⁵⁾ SKD..SL with 800 N positioning force





Product documentation

- Mounting Instructions M4030 74 319 0749 0
- Basic documentation P4030 Contains background information and technical basic knowledge of valves

Technical and mechanical design



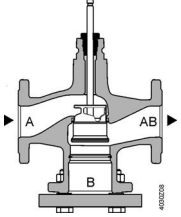
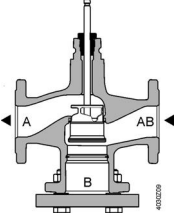

The illustrations below show the basic design of the valves. Constructional features, such as the shape of plugs, may differ.

2-port valves

 Fluids	 Steam (Fluids possible)
 Closing against the pressure	 Closing with the pressure
	
A → AB For use with all actuators	A ← AB Use with electro-hydraulic actuators only

2-port valves pressure compensated

The VVF53..K valves use a pressure-compensated plug. This enables the same type of actuators to be used for the control of volumetric flow at higher differential pressures.

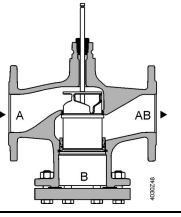
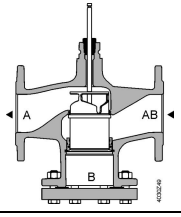
 Fluids	 Steam
 Closing against the pressure	 Closing with the pressure
	
A → AB For use with all actuators	A ← AB Use with electro-hydraulic actuators only



Note

2-port valves do not become 3-port valves by removing the blank flange!

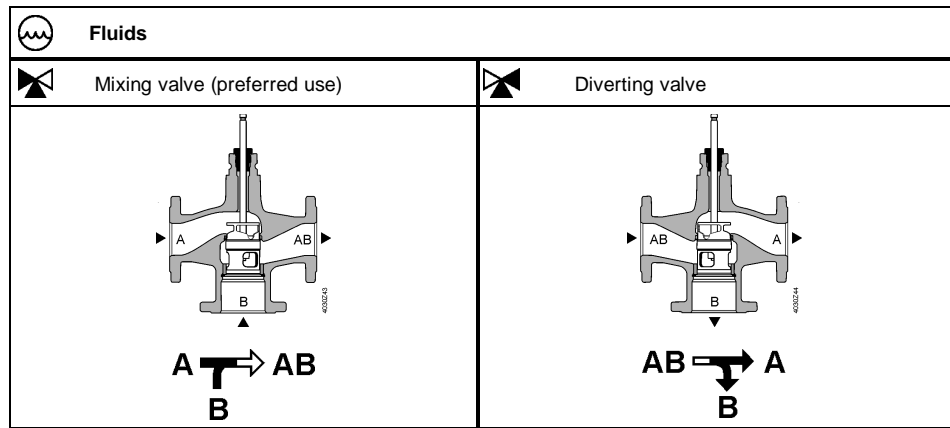
3-port valves



Accessories

Product number	Stock number	Description	Note	
ASZ6.5	ASZ6.5	Stem heating element	Required for medium temperatures < 0 °C	
ASZ6.6	S55845-Z108			
-	428488060	Stem sealing gland	When using valves of the V..F53.. lines with a stem heating element and a medium temperature below -5 °C, the stem sealing gland must be replaced. With the gland 428488060 the valve can be used with water, water with antifreeze and brines between -20° C and + 150° C.	

Adapter type	Stock number	Bolts included	Description	VXF41..	
ALF41B15	S55845-Z110	4x M12x90mm	Adapter for replacing 3-port valves VXF41.. by VXF53.. • Due to different dimensions of the bypass flange • Every valve to be replaced requires an adapter • Adapter is supplied with the required number and size of bolts and nuts as well as two suitable flat sealings Replace 3-port valves VXF41..., DN 65...150 by 3-port valvesVXF43.. (data sheet N4404).	DN 15	
ALF41B25	S55845-Z111	4x M12x90mm		DN 25	
ALF41B40	S55845-Z112	4x M16x90mm		DN 40	
ALF41B50	S55845-Z113	4x M16x90mm		DN 50	

Sizing

Flow chart

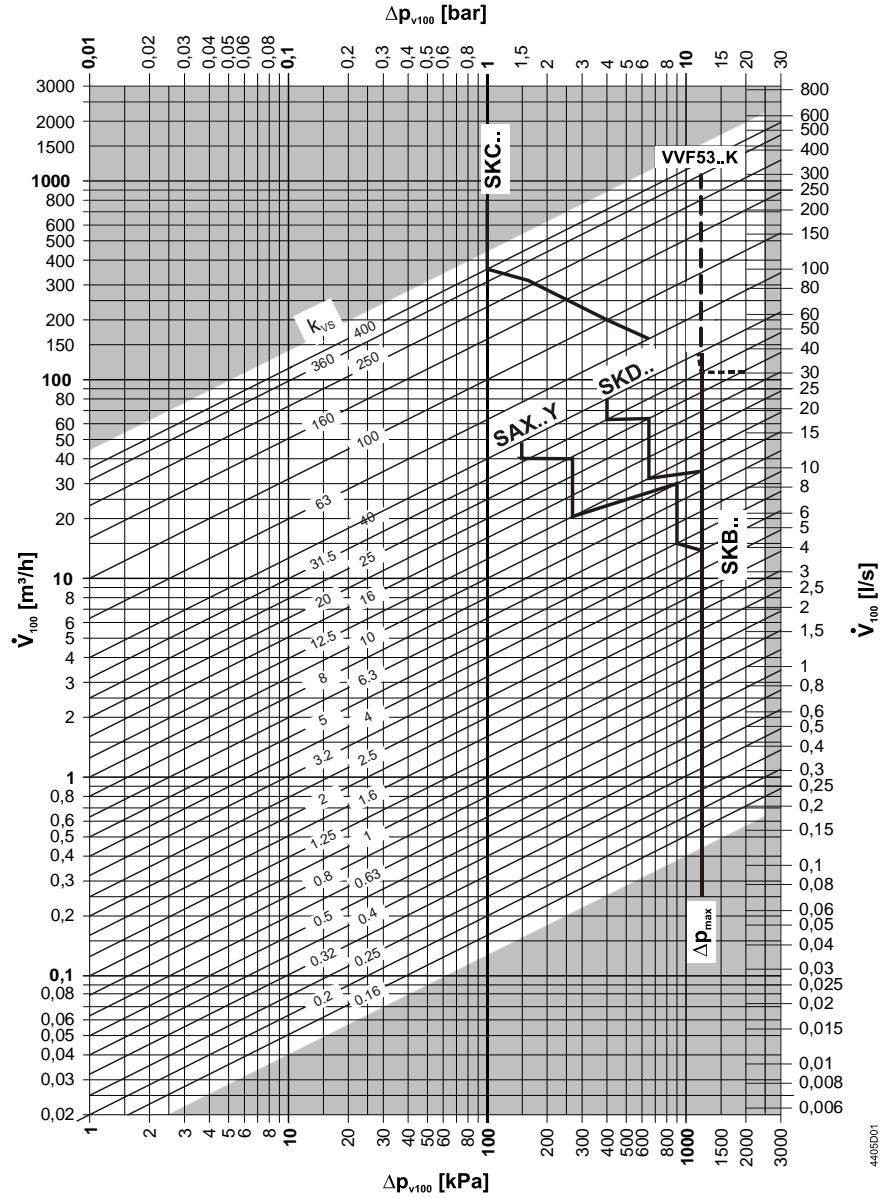

Δp_{max} values apply for the mixing function. Δp_{max} values for the diverting function see table "Type summary", page 2

Δp_{max} values for K_{vs} value 16, DN 32, see table "Type summary", page 2

**Valve characteristics
2-port valves**

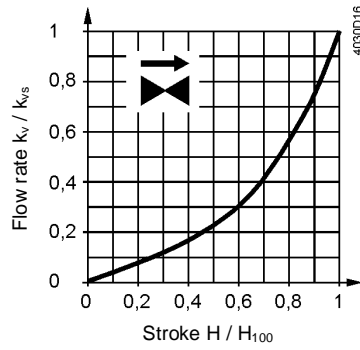

0...30%: Linear
30...100%: Equal percentage
 $n_{gl} = 3$ to VDI / VDE 2173

For high k_{vs} values the valve characteristic is optimized for maximum volumetric flow k_{V100} .

For product lines:
VVF53.125-250
VVF53.125-250K
VVF53.150-400
VVF53.150-360K

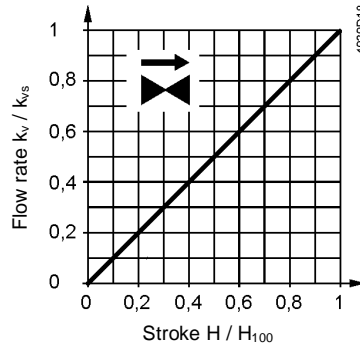

0...100%: Linear

3-port valves

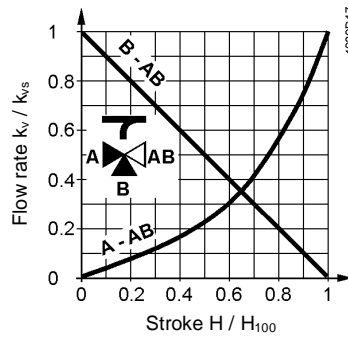

Throughport A-AB

0...30%: Linear
30...100%: Equal percentage
 $n_{gl} = 3$ to VDI / VDE 2173

For high k_{vs} values the valve characteristic is optimized for maximum volumetric flow k_{V100} .

Bypass B-AB

0...100%: Linear

Port AB = constant volumetric flow
Port A = variable volumetric flow
Port B = Bypass (variable volumetric flow)

Mixing: Volumetric flow from port A and port B to port AB

Diverting: Volumetric flow from port AB to port A and port B

For product lines:
VXF53.125-250
VXF53.150-400

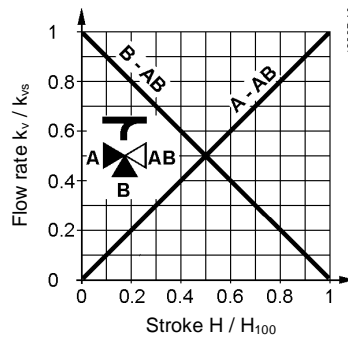

Throughport A-AB

0...100%: Linear

Bypass B-AB

0...100%: Linear

Operating pressure and medium temperature

Fluids
with V..F53..

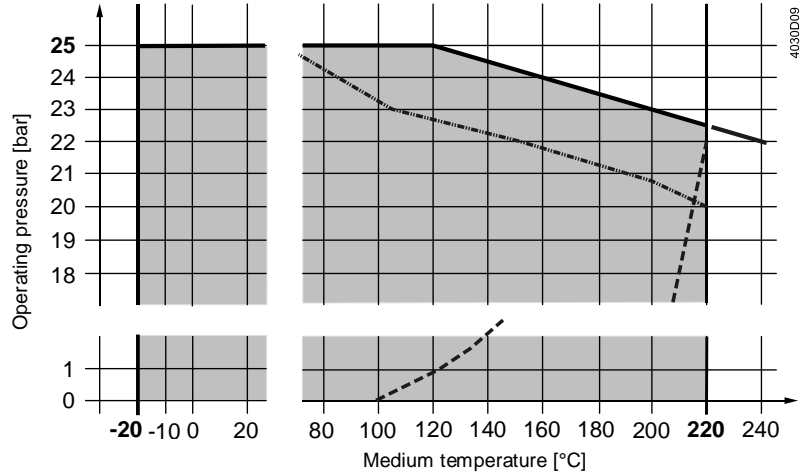

- Curve for saturated steam; steam forms below this line
- .. Operating pressure according to EN 1092, valid for 2-port valves with blank flange

Operating pressure and operating temperatures according to ISO 7005, EN 1092 and EN 12284

Notes

All relevant local directives must be observed

Saturated steam
Superheated steam
with VVF53..

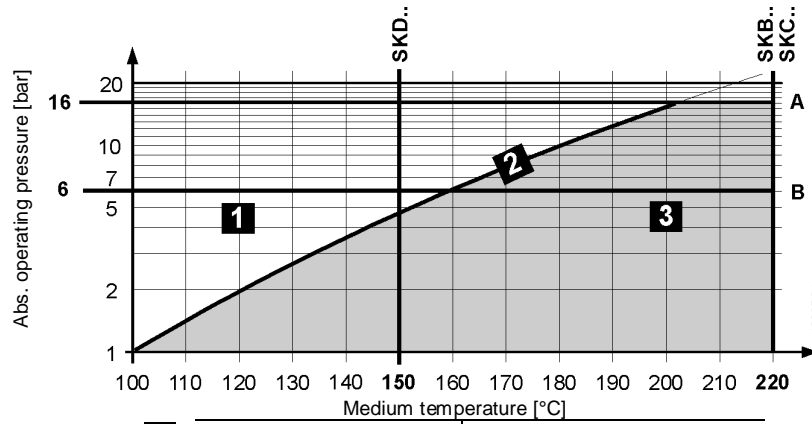

1	Wet steam	To be avoided
2	Saturated steam	Permissible operating range
3	Superheated steam	
A	Subcritical pressure ratio	
B	Supercritical pressure ratio	

Medium compatibility and temperature ranges

Medium	Temperature range		Valve			Note
	T _{min} [°C]	T _{max} [°C]	VVF53..	VVF53..K	VXF53..	
Cold water	1	25	■	■	■	-
Low-temperature hot water	1	130	■	■	■	-
High-temperature hot water ¹⁾	130	150	■	■	■	-
	150	180	■	■	■	-
	180	220	■	■	■	-
Water with antifreeze	-5	150	■	■	■	V..F53: With a medium temperature of below -5 °C, the stem sealing gland must be replaced by the gland 428488060
	-10	150	■	- ⁴⁾	■	
	-20	150	■	- ⁴⁾	■	
Cooling water ²⁾	1	25	■	■	■	-
Brines	-5	150	■	■	■	V..F53: With a medium temperature of below -5 °C, the stem sealing gland must be replaced by the gland 428488060
	-10	150	■	- ⁴⁾	■	
	-20	150	■	- ⁴⁾	■	
Saturated steam ³⁾	100	150	■	■	-	-
	100	220	■	■	-	-
Superheated steam	120	150	■	■	-	-
	120	220	■	■	-	-
Heat transfer oils	20	220	■	■	■	On the basis of mineral oil
Super-clean water (demineralized and deionized)	1	150	-	-	-	

¹⁾ Differentiation due to saturated steam curve

²⁾ Open circuits

³⁾ Operate with inverted flow direction with steam

⁴⁾ VVF53..K can't be used with media below -5°C due to the compensation sealing material

Fields of use

Fields of use		Valve	
		VVF53..	VXF53..
Generation	Boiler plants	■	■
	District heating plants	■	-
	Refrigeration plants	■	■
	Cooling towers ¹⁾	■	■
Distribution	Heating groups	■	■
	Air handling units	■	■

¹⁾ Open circuits

Engineering notes

Mounting location	Preferably mount the valves at the return, as the temperature is lower there and the strain on the stem sealing gland is lower. Operate valves of the product lines VVF53.. with inverted flow direction for steam.
Dirt trap	Mount a dirt filter or dirt trap before the valve to ensure proper functioning, and a long service life of the valve.
Cavitation	Remove dirt, welding beads, etc. from the valves and pipes. Cavitation can be avoided by limiting the pressure differential across the valve depending on the medium temperature and the prepressure.

Mounting notes

Mounting position

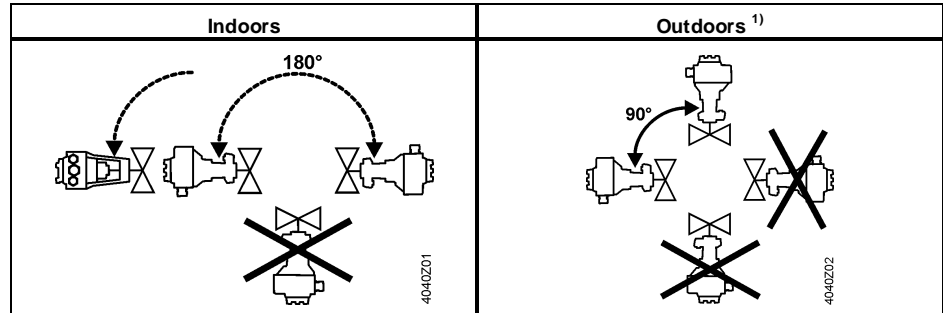

¹⁾ Only in combination with weather shield ASK39.1 and actuators SAX..

Mounting positions apply to both 2- and 3-port valves.

Commissioning notes



The valve may be put into operation only if actuator and valve are correctly assembled.

Note

Ensure that actuator stem and valve stem are rigidly connected in all positions.

Function check

Valve	Throughport A→AB	Bypass B→AB
Valve stem extends	Closes	Opens
Valve stem retracts	Opens	Closes

Maintenance notes

The valves are maintenance-free.



When servicing valves or actuators:

- Deactivate the pump and turn off the power supply
- Close the shutoff valves
- Fully reduce the pressure in the piping system and allow pipes to completely cool down

If necessary, disconnect the electrical wires.

Due to the different types of material used, the valve must be disassembled prior to disposal. Special handling of certain valve components may be required by law or may be sensible from an ecological point of view.

Local and currently valid legislation must be observed.

Disposal



Warranty

Application-related technical data are guaranteed only when the valves are used in connection with the Siemens actuators listed under "Equipment combinations", page 3.

When used with actuators of other manufacture, any warranty by Siemens becomes void.

Technical Data

Functional data	PN class	PN 25	
	Connection	Flange	
	Operating pressure	See Section "Operating pressure and medium temperatures" page 9	
	Valve characteristics ¹⁾	See section "Valve characteristics", page 8	
	Leakage rate	Throughport	0...0.01% of k_{vs} value (Class IV)
		Bypass	0.5...2% of k_{vs} value with SKD.., SKB.., SKC.. 0.05% of k_{vs} value with SAX..
	Permissible media	See table " Medium compatibility and temperature ranges", page 10	
	Medium temperature		-20...220 °C ²⁾
			VVF53..K: 1...220 °C
	Rangeability		DN 15, $k_{vs} \leq 1.25 \text{ m}^3/\text{h}$: >50
			DN 15...150: >100
Nominal stroke		Up to DN 50: 20 mm From DN 65: 40 mm	
Materials	Valve body	EN-GJS-400-18-LT	
	Blank flange	VVF.. P265GH	
	Valve stem, seat, plug	Stainless steel	
	Stem sealing gland		Stainless steel
			FEPM (silicone-free)
	Compensation sealing		Stainless steel
		FEPM (silicone-free)	
Adapter ALF41B..		Steel S235JRG2	
Standards	Pressure Equipment Directive	PED 97/23/EC	
	Pressure-carrying accessories	According to article 1, section 2.1.4	
	Fluid group 2		PN 25
		without CE certification according to article 3, section 3 (good engineering practice)	\leq DN 40
		Category I, with CE certification	DN 50...100
	Category II, with CE certification, notified body identification number 0036	DN 125...150	
	PN class		ISO 7268
	Operating pressure		ISO 7005, DIN EN 12284
	Flanges		ISO 7005
	Length of flanged valves		DIN EN 558-1, line 1
	Valve characteristic		VDI 2173
Leakage rate		Throughport, Bypass according to EN 60534-4 / EN 1349	
Water treatment		VDI 2035	

Environmental conditions	
Storage: IEC 60721-3-1	Class 1K3 Temperature -15...+55 °C Rel. humidity 5...95% r.H.
Transport: IEC 60721-3-2	Class 2K3, 2M2 Temperature -30...+65 °C Rel. humidity < 95% r.H.
Operation: IEC 60721-3-3	Class 3K5, 3Z11 Temperature -15...+55 °C Rel. humidity 5...95% r.H.
Environmental compatibility	ISO 14001 (environment) ISO 9001 (quality) SN 36350 (environmentally compatible products) RL 2002/95/EG (RoHS)
Dimensions / Weight	See „Dimensions“, page 13
Dimensions	See „Dimensions“, page 13
Weight	See „Dimensions“, page 13

- 1) For certain valve lines and high k_{vs} values, the valve characteristic is optimized for maximum volumetric flow k_{V100}
- 2) For medium temperatures < -5 °C, the stem sealing gland must be replaced. The sealing gland must be ordered separately (Stock number: 4 284 8806 0).

Dimensions

VVF53..

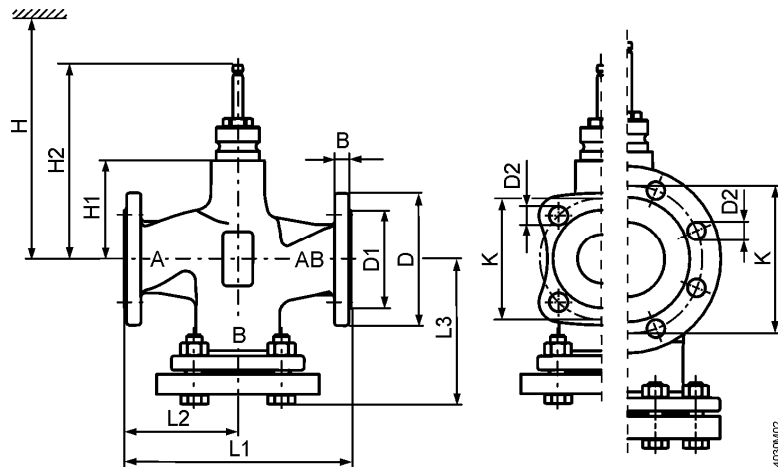

Product number	DN	kg	B	Ø D	Ø D1	Ø D2	L1	L2	L3	Ø K	H1	H2	H			
													SAX..	SKD..	SKB..	SKC..
VVF53..	15	4.2	14	95	46	14 (4x)	130	65	87.5	65	63	159.5	505	563	638	-
	20	5.3	16	105	56	14 (4x)	150	75	99.5	75	63	144.4	505	563	638	-
	25	6.1	15	115	65	14 (4x)	160	80	104.5	85	63	159.5	505	563	638	-
	32	8.7	17	140	76	19 (4x)	180	90	119	100	60	156.5	502	560	635	-
	40	10.1	16	150	84	19 (4x)	200	100	129	110	60	156.5	502	560	635	-
	50	13.5	16	165	99	19 (4x)	230	115	146	125	100	196.5	542	600	675	-
	65	21.9	17	185	118	19 (8x)	290	145	178	145	115	231.5	-	-	-	690
	80	27.4	17	200	132	19 (8x)	310	155	190	160	115	231.5	-	-	-	690
	100	38.2	17	235	156	23 (8x)	350	175	212.5	190	146	262.5	-	-	-	721
125	54	17	270	184	28 (8x)	400	200	242	220	159	275.5	-	-	-	734	
150	74	17	297	211	28 (8x)	480	240	284	250	186.5	303	-	-	-	762	
VVF53..K	50	13.6	16	165	99	19 (4x)	230	115	146	125	100	196.5	542	600	675	-
	65	22.3	17	185	118	19 (8x)	290	145	178	145	115	231.5	-	-	-	690
	80	27.9	17	200	132	19 (8x)	310	155	190	160	115	231.5	-	-	-	690
	100	39.0	17	235	156	23 (8x)	350	175	212.5	190	146	262.5	-	-	-	721
	125	57.5	17	270	184	28 (8x)	400	200	242	220	159	275.5	-	-	-	734
150	75.8	17	297	211	28 (8x)	480	240	284	250	186.5	303	-	-	-	762	

VXF53..

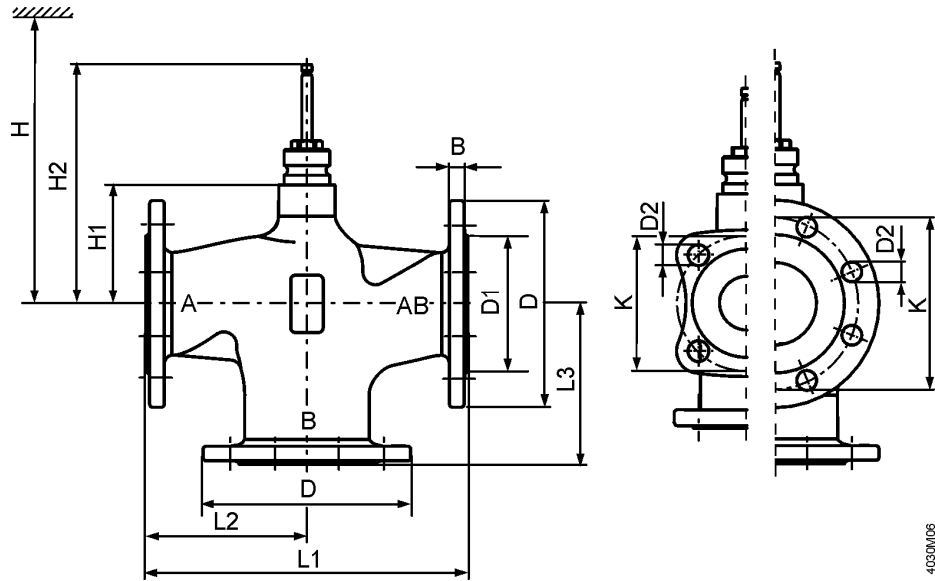

40301/06

Product number	DN	kg	B	Ø D	Ø D1	Ø D2	L1	L2	L3	Ø K	H1	H2	H			
													SAX..	SKD..	SKB..	SKC..
VXF53..	15	3.2	14	95	46	14 (4x)	130	65	65	65	63	159.5	505	563	638	-
	20	4.0	16	105	56	14 (4x)	150	75	75	75	63	159.5	505	563	638	-
	25	4.6	15	115	65	14 (4x)	160	80	80	85	63	159.5	505	563	638	-
	32	6.1	17	140	76	19 (4x)	180	90	90	100	60	156.5	502	560	635	-
	40	7.2	16	150	84	19 (4x)	200	100	100	110	60	156.5	502	560	635	-
	50	9.7	16	165	99	19 (4x)	230	115	115	125	100	196.5	542	600	675	-
	65	16.6	17	185	118	19 (8x)	290	145	145	145	115	231.5	-	-	-	690
	80	20.9	17	200	132	19 (8x)	310	155	155	160	115	231.5	-	-	-	690
	100	28.5	17	235	156	23 (8x)	350	175	175	190	146	262.5	-	-	-	721
	125	42.2	17	270	184	28 (8x)	400	200	200	220	159	275.5	-	-	-	734
150	55.9	17	297	211	28 (8x)	480	240	240	250	186.5	303	-	-	-	762	

Spare parts

Stem sealing gland

Product number	DN	Stock number	Comments	
VVF53.. VXF53..	DN 15...150	74 284 0061 0	-	
		4 284 8806 0	When operating with medium temperatures below -5 °C . With the gland 428488060 the valve can be used with water, water with antifreeze and brines between 20° C and 150° C.	

Revision numbers

Product number	Valid from rev. no.	Product number	Valid from rev. no.	Product number	Valid from rev. no.
VVF53.15-0.16	..A	VVF53.50-40K	..A	VXF53.15-1.6	..A
VVF53.15-0.2	..A	VVF53.65-63K	..A	VXF53.15-2.5	..A
VVF53.15-0.25	..A	VVF53.80-100K	..A	VXF53.15-4	..A
VVF53.15-0.32	..A	VVF53.100-160K	..A	VXF53.20-6.3	..A
VVF53.15-0.4	..A	VVF53.125-250K	..A	VXF53.25-6.3	..A
VVF53.15-0.5	..A	VVF53.150-360K	..A	VXF53.25-10	..A
VVF53.15-0.63	..A			VXF53.32-16	..A
VVF53.15-0.8	..A			VXF53.40-16	..A
VVF53.15-1	..A			VXF53.40-25	..A
VVF53.15-1.25	..A			VXF53.50-40	..A
VVF53.15-1.6	..A			VXF53.65-63	..A
VVF53.15-2	..A			VXF53.80-100	..A
VVF53.15-2.5	..A			VXF53.100-160	..A
VVF53.15-3.2	..A			VXF53.125-250	..A
VVF53.15-4	..A			VXF53.150-400	..A
VVF53.20-6.3	..A				
VVF53.25-5	..A				
VVF53.25-6.3	..A				
VVF53.25-8	..A				
VVF53.25-10	..A				
VVF53.32-16	..A				
VVF53.40-12.5	..A				
VVF53.40-16	..A				
VVF53.40-20	..A				
VVF53.40-25	..A				
VVF53.50-31.5	..A				
VVF53.50-40	..A				
VVF53.65-63	..A				
VVF53.80-100	..A				
VVF53.100-160	..A				
VVF53.125-250	..A				
VVF53.150-400	..A				

