

Description



- Passive infrared presence detector for ceiling installation and flush/surface mounting
- Square detection area 360° (up to 100 m²) for accurate and easy planning
- Automatic presence- and brightness-dependent control for lighting and HVAC
- Flat design with exchangeable cover frame in a range of shapes and colours
- 3 x mixed light measurement suitable for fluorescent lamps (FL/PL/ESL), halogen/incandescent lamps and LEDs
- 2 independent constant light controllers #3050 for controlling two light groups
 - Switching or constant light control with standby function
 - Fully or semi-automatic function mode
- 3 x occupancy controller #3071
 - for controlling the constant light controller or use as presence channels
- 3 x light sensor #1010
- Occupancy sensor #1060
- Plug-in for convenient adjustment of parameters and functionality
- Brightness set point value can be set via network variables
- Scene Panel #3250 can be used with the theSenda S user remote control
- Integrated scene module (Scene controller #3251)
- Parallel switching of multiple presence detectors without logic modules
- Adjustable sensitivity
- Can be configured remotely and selection of set parameters
- SendoPro management remote control (optional)
- theSenda S user remote control (optional)
- LONMARK certified

Technical data

Topology	LON FTT
Operating voltage	24 V AC/DC AC +10%/-20% DC ±20%
Installation height	2 – 3,5 m
Installation type	Flush/surface mounting (UWH) or ceiling mounting with mounting frame (EWH)
Power consumption	~30 mA
Light measurement	Mixed light measurement
Setting range brightness	10 – 2000 lx
Switch-off delay	10 s – 100 min
Lamps	Incandescent/halogen lamps, fluorescent lamps, Energy saving lamps, LEDs
Switch-on delay presence	10 s – 30 min / inactive
Type of connection	Spring terminals WAGO 243
Ambient temperature	+0 °C ... +50 °C
Type of protection	IP 40
Conformity to type CE 	This device complies with the protection regulations of the EMC directives 2004/108/EC.

Description

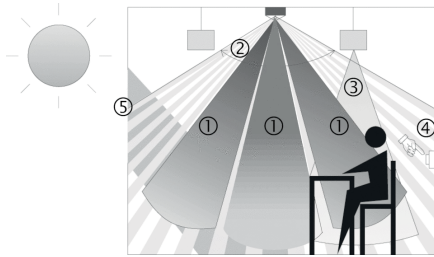

- 1 Mixed light measurement (3x)
- 2 Presence detection
- 3 Artificial light
- 4 Push button for manual lighting control
- 5 Incident daylight

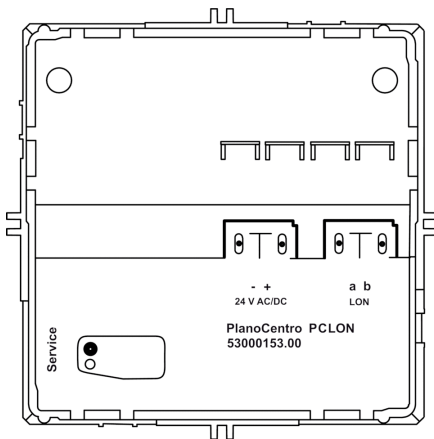

Settings on PlanoCentro

- 1 Service: Service key for identification of the Neuron ID.

The PlanoCentro PCLON presence detector uses the following standardised LONMARK function profile. The function of the presence detector is dependent on the connections of the function profile and its parameters.

Light sensor (3 x LONMARK profile 1010)

There are 3 function profiles for the light sensor available, corresponding to the three light measurements of the presence detector: window, centre and inner zone. Every light sensor sends the current brightness value in Lux at the place where the detector was installed over the Lonworks network, either cyclically or in case of sufficiently large changes. The measured brightness value can be adapted to the current situation in the room with a calibration (room correction factor).

Occupancy sensor (LONMARK profile 1060)

If the presence detector detects a movement, the output of the occupancy sensor will be set to the state OCCUPIED. This presence signal is used, for example, by an occupancy controller for presence-dependent control.

Occupancy controller (3 x LONMARK profile 3071)

There are 3 occupancy controller-type function profiles available for presence-dependent control of light channels or other controllers. The three outputs can be used universally. For example, one can be used to control both light outputs, a second controls the wall panel light group depending on the brightness level, while a third is used for presence-dependent HVAC control. The presence test mode is also part of the occupancy controller.

Constant light controller (2 x LONMARK profile 3050)

There are 2 function profiles of the constant light controller type available. Each of the two constant light controllers optionally supports the daylight-dependent switching function or constant light control. Both controllers can be used independently of one another. By selecting between three directional light measurements, two light groups can be switched or regulated independently of one another. The lighting can be manually switched or dimmed at any time via a push button. A short button press switches the light on or off, a longer button press dims the light down or up (with constant light control). Depending on which of the two network variables was used, different behaviour appears after the manual override:

- Manual dimming stops the constant light control.
- Constant light control remains active after manual dimming to new brightness set point value.

Remote control (2 x LONMARK function profile 3200)

2 function profiles for remote control are available, one for each button series on the user remote control theSenda S. Every function profile passes on the IR commands received from the user remote control theSenda S to the configured output variables for control of blinds, lights, etc. This allows either the light groups controlled by the presence detector itself to be manually switched and dimmed or external light groups or blinds to be operated

Scene panel (LONMARK function profile 3250)

The scene panel broadcasts the scene numbers which can be triggered via both scene buttons on the user's theSenda S remote control

Scene controller (LONMARK function profile 3251)

The scene controllers are controlled either from external scene buttons or by the user's theSenda S remote control via the scene panel of the presence detector. 8 free storage locations are available for scenes.

Detection range

The square detection ranges ensure safe and simple planning. Connected in parallel, they allow the entire room to be covered. Please note the difference in size of the detection ranges for seated and walking persons. The recommended mounting height is 2 m - 3.5 m. The sensitivity of the detector decreases with increasing mounting height. From a mounting height of more than 4 m walking movements are required for detection, and the detection ranges of multiple detectors should overlap in their fringe zones.

Seated persons

The presence detector reacts very sensitively to the slightest movements. The values given refer to the restricted detection range for movements taking place at table height, i.e. approx. 0.80 m above the floor. From a mounting height of more than 4 m, the sensitivity of the detector is limited, and more distinct movements are required for detection.

Walking persons

For walking persons, the entire detection range is valid with a small tolerance in the fringe zone (+/- 0.5 m).

Mounting height (A)	Sitting (S)	Walking (T)
2 m	20 m ² 4,5 m x 4,5 m	36 m ² 6 m x 6 m ± 0,5 m
2,5 m	36 m ² 6 m x 6 m	64 m ² 8 m x 8 m ± 0,5 m
3 m	49 m ² 7 m x 7 m	81 m ² 9 m x 9 m ± 1 m
3,5 m	64 m ² 8 m x 8 m	100 m ² 10 m x 10 m ± 1 m

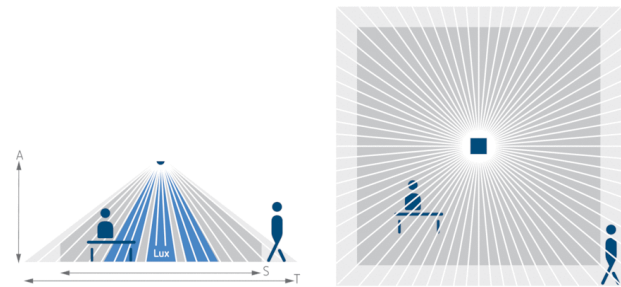

Brightness Measurement

The presence detector measures artificial and natural light through three directional light measurements, which is reflected below the detector (beam angle for each approx. ± 30°). The central light measurement detects the brightness directly below the detector, while the two other light measurements detect the brightness close to the window or in the interior. The installation site is a reference point for the lighting level. Brightness measurement can be adapted to the conditions in a room with the room correction factor. Direct light influences the light measurement. The placement of the floor lamps or suspended lighting directly below the detector is to be avoided..

Suitable lamps

The presence detector is designed for the operation for fluorescent lamps, compact fluorescent lamps, halogen/ incandescent lamps and LEDs.

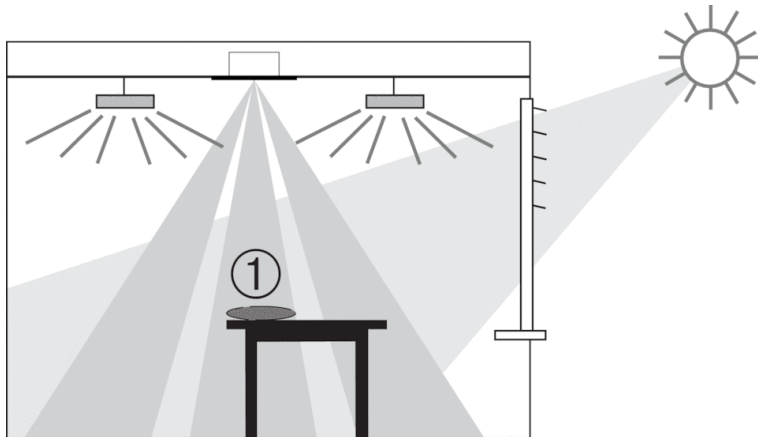

Scale drawings

PlanoCentro...-U...

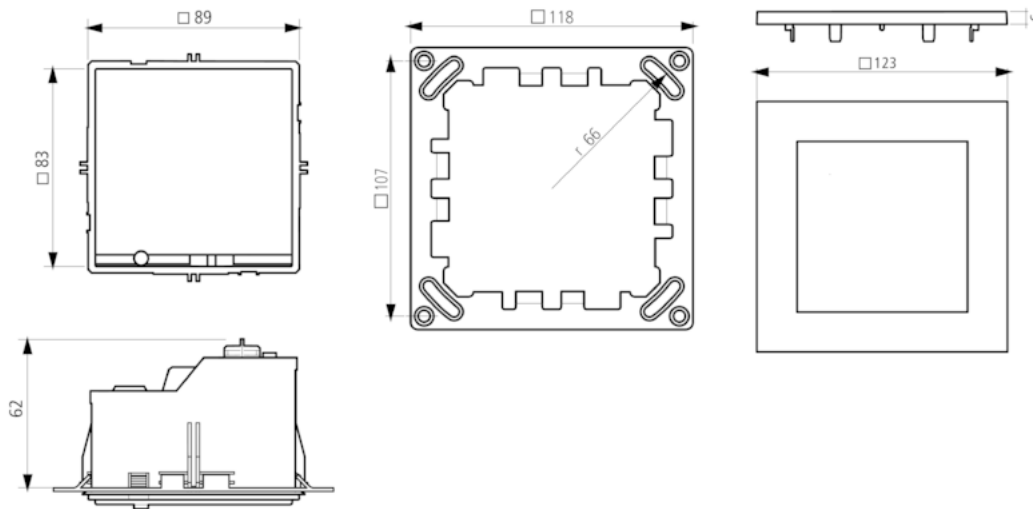

PlanoCentro...-E...

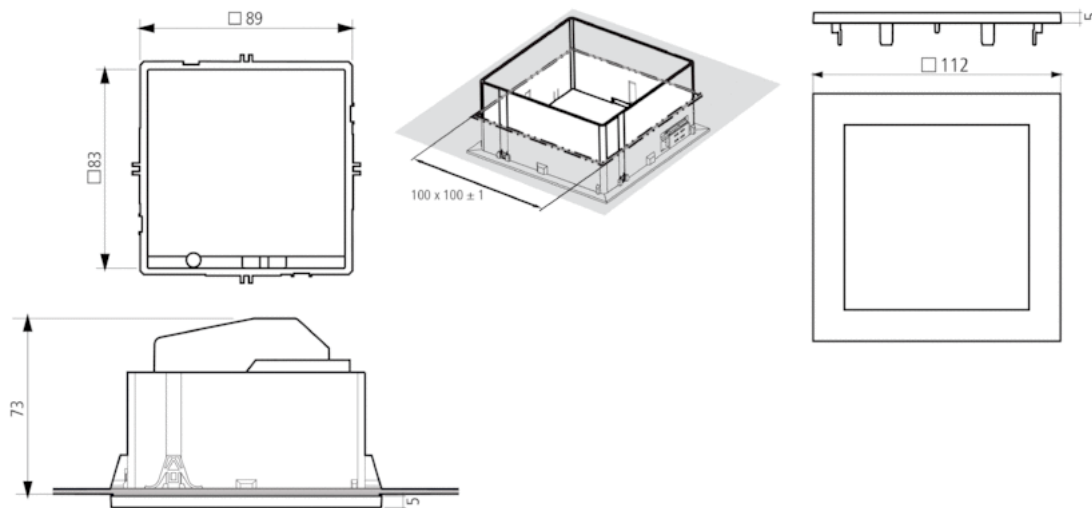

Accessories

PlanoCover 123x123 EBK

- Article number: 9070681
[Details ▶ www.theben.de](http://www.theben.de)



PlanoCover 123x123 ESR

- Article number: 9070682
[Details ▶ www.theben.de](http://www.theben.de)



Junction casing, 115x115x100 mm

- Article number: 9070689
[Details ▶ www.theben.de](http://www.theben.de)

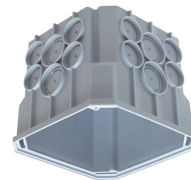

PlanoBox 1WH

- Article number: 9070731
[Details ▶ www.theben.de](http://www.theben.de)

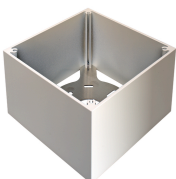

SendoPro 868-A

- Article number: 9070675
[Details ▶ www.theben.de](http://www.theben.de)



theSenda S

- Article number: 9070911
[Details ▶ www.theben.de](http://www.theben.de)



Article number: 2069202

QuickSafe

- Article number: 9070531
 Details ▶ www.theben.de



Product selection

Installation type	Channel	Operating voltage	Colour	Type	Article number
Ceiling mounting with mounting frame	2 x Light 2 x Occupancy	24 V AC/DC LON FTT	Pure white (similar to RAL 9010)	PlanoCentro EWH PCLON	2069102
Ceiling mounting with mounting frame	2 x Light 2 x Occupancy	24 V AC/DC LON FTT	Black (similar to RAL 9005)	PlanoCentro EBK PCLON	2069103
Ceiling mounting with mounting frame	2 x Light 2 x Occupancy	24 V AC/DC LON FTT	Silver (similar to RAL 9006)	PlanoCentro ESR PCLON	2069104
Ceiling installation (flush-mounting concrete)	2 x Light 2 x Occupancy	24 V AC/DC LON FTT	Pure white (similar to RAL 9010)	PlanoCentro UWH PCLON	2069202
Ceiling installation (flush-mounting concrete)	2 x Light 2 x Occupancy	24 V AC/DC LON FTT	Black (similar to RAL 9005)	PlanoCentro UBK PCLON	2069203
Ceiling installation (flush-mounting concrete)	2 x Light 2 x Occupancy	24 V AC/DC LON FTT	Silver (similar to RAL 9006)	PlanoCentro USR PCLON	2069204

Installation type

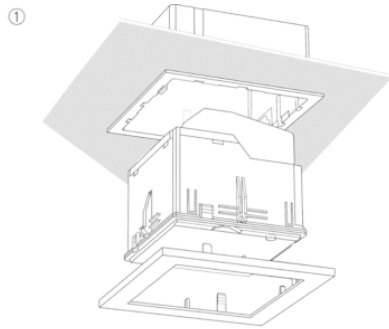

The PlanoCentro is available with installation sets for ceiling mounting and flush-mounted installation. The housing conforms with the fire safety standard EN 60670-1 (glow wire tested 850°).

Ceiling installation (false ceilings) (1)

Ceiling installation is completed using a supplied installation frame measuring 100 x 100 mm ± 1 mm (2)

PlanoCentro EWH, PlanoCentro EBK, PlanoCentro ESR

Flush-mounted installation (concrete ceiling) (3)

The PlanoCentro fits in the Agro/Kaiser flush-mounted junction box/connection box 115 x 115 x 100 mm

PlanoCentro UWH, PlanoCentro UBK, PlanoCentro USR

