

# MCmultizone

atomising humidifiers

# CAREL



**ENG** User manual

**→ LEGGI E CONSERVA  
QUESTE ISTRUZIONI ←**  
**→ READ AND SAVE  
THESE INSTRUCTIONS ←**

Integrated Control Solutions & Energy Savings



**WARNINGS**

CAREL S.p.A. humidifiers are advanced products, whose operation is specified in the technical documentation supplied with the product or can be downloaded, even prior to purchase, from the website [www.carel.com](http://www.carel.com). Each CAREL S.p.A. product, in relation to its advanced level of technology, requires setup/configuration/programming/commissioning to be able to operate in the best possible way for the specific application. The failure to complete such operations, which are required/indicated in the user manual, may cause the final product to malfunction; CAREL S.p.A. accepts no liability in such cases.

The customer (manufacturer, developer or installer of the final equipment) accepts all liability and risk relating to the configuration of the product in order to reach the expected results in relation to the specific final installation and/or equipment. CAREL S.p.A. may, based on prior agreements, act as a consultant for the installation/commissioning/use of the unit, however in no case does it accept liability for the correct operation of the humidifier and the final installation if the warnings or suggestions provided in this manual or in other product technical documents are not heeded. In addition to observing the above warnings and suggestions, the following warnings must be heeded for the correct use of the product:

- **DANGER OF ELECTRIC SHOCK**

The humidifier contains live electrical components. Disconnect the mains power supply before accessing inside parts or during maintenance and installation.

- **DANGER OF WATER LEAKS**

The humidifier automatically and constantly fills/drains certain quantities of water. Malfunctions in the connections or in the humidifier may cause leaks.

**Important:**

- The installation of the product must include an earth connection, using the special yellow-green terminal available in the humidifier.
- The environmental and power supply conditions must conform to the values specified on the product rating labels.
- The product is designed exclusively to humidify rooms either directly or through distribution systems (ducts, atomising racks).
- Only qualified personnel who are aware of the necessary precautions and able to perform the required operations correctly may install, operate or carry out technical service on the product.
- For the production of atomised water, only use water with the characteristics specified in this manual. Important, demineralised drinking water must be used (as specified in the manual). In addition, the particles of water that are not absorbed by the air must be removed using the droplet collection tank (in the humidification section) and the droplet separator (at the end of the humidification section).
- All operations on the product must be carried out according to the instructions provided in this manual and on the labels applied to the product. Any uses or modifications that are not authorised by the manufacturer are considered improper. CAREL S.p.A. declines all liability for any such unauthorised use.
- Do not attempt to open the humidifier in ways other than those specified in the manual.
- Observe the standards in force in the place where the humidifier is installed.
- Keep the humidifier out of the reach of children and animals.
- Do not install and use the product near objects that may be damaged when in contact with water (or condensate). CAREL S.p.A. declines all liability for direct or indirect damage following water leaks from the humidifier.
- Do not use corrosive chemicals, solvents or aggressive detergents to clean the inside and outside parts of the humidifier, unless specifically indicated in the user manual.
- Do not drop, hit or shake the humidifier, as the inside parts and the linings may be irreparably damaged.

CAREL S.p.A. adopts a policy of continual development. Consequently, CAREL reserves the right to make changes and improvements to any product described in this document without prior warning. The technical specifications shown in the manual may be changed without prior warning.

The liability of CAREL S.p.A. in relation to its products is specified in the CAREL S.p.A. general contract conditions, available on the website [www.carel.com](http://www.carel.com) and/or by specific agreements with customers; specifically to the extent where allowed by applicable legislation, in no case will CAREL S.p.A., its employees or subsidiaries be liable for any lost earnings or sales, losses

of data and information, costs of replacement goods or services, damage to things or people, downtime or any direct, indirect, incidental, actual, punitive, exemplary, special or consequential damage of any kind whatsoever, whether contractual, extra-contractual or due to negligence, or any other liabilities deriving from the installation, use or impossibility to use the product, even if CAREL S.p.A. or its subsidiaries are warned of the possibility of such damage.

**DISPOSAL**

The humidifier is made up of metal parts and plastic parts. In reference to European Union directive 2002/96/EC issued on 27 January 2003 and the related national legislation, please note that:



1. WEEE cannot be disposed of as municipal waste and such waste must be collected and disposed of separately;
2. the public or private waste collection systems defined by local legislation must be used. In addition, the equipment can be returned to the distributor at the end of its working life when buying new equipment;
3. the equipment may contain hazardous substances: the improper use or incorrect disposal of such may have negative effects on human health and on the environment;
4. the symbol (crossed-out wheeled bin) shown on the product or on the packaging and on the instruction sheet indicates that the equipment has been introduced onto the market after 13 August 2005 and that it must be disposed of separately;
5. in the event of illegal disposal of electrical and electronic waste, the penalties are specified by local waste disposal legislation.

**Warranty on materials:** 2 years (from the date of production, excluding consumables).

**Approval:** the quality and safety of CAREL S.P.A. products are guaranteed by the ISO 9001 certified design and production system, as well as by the  mark..



# Content

<b>1. INTRODUCTION AND ASSEMBLY</b>	<b>7</b>	6.6 Scheduled set points.....	23
1.1 MCmultizone atomising humidifier .....	7	<b>7. INSTALLER MENU</b> 	<b>24</b>
1.2 Models .....	7	7.1 Type of control .....	24
1.3 Dimensions and weights .....	7	7.2 Probe configuration.....	24
1.4 Components .....	8	7.3 Operating options .....	24
1.5 Electrical specifications.....	8	7.4 Special functions .....	24
1.6 Opening the packaging .....	8	7.5 Supervisor.....	25
1.7 Positioning the cabinet .....	8	7.6 External alarms.....	25
1.8 Wall mounting.....	8	7.7 pLAN configuration .....	25
1.9 Opening the cabinet door .....	9	<b>8. MAINTENANCE MENU</b> 	<b>26</b>
1.10 Components and accessories .....	9	8.1 Reset configurations .....	26
<b>2. WATER AND AIR CONNECTIONS</b>	<b>10</b>	8.2 System information (read only).....	26
2.1 Characteristics of the water line.....	11	8.3 Manual procedure .....	26
2.2 Type of supply water .....	11	8.4 Hour counter.....	26
2.3 Characteristics of the air line .....	11	8.5 Alarm log.....	26
2.4 Type of compressed air.....	11	<b>9. TABLE OF ALARMS</b>	<b>27</b>
2.5 Type of water and air lines.....	11	<b>10. ADVANCED FUNCTIONS</b>	<b>28</b>
2.6 Water and air line accessories.....	11	10.1 Wiring diagrams.....	28
<b>3. ELECTRICAL CONNECTIONS</b>	<b>12</b>	10.2 Operating principle.....	32
3.1 Power supply .....	13	10.3 Control principles.....	32
3.2 Remote ON/OFF (ID & COM).....	13	10.4 Pressure control.....	34
3.3 Modulating control signal (J24 & J2).....	13	10.5 Drain/fill.....	34
3.4 Control signals from ext. voltage-free contact i.e. ON/OFF humidistat (ID & COM).....	14	10.6 Periodical washing of the water line.....	34
3.5 Control signals from air line pressure transducer (J2) .....	15	10.7 Automatic cleaning of the atomising heads.....	34
3.6 Connection of NO drain solenoid valve at end of water line (group of ID terminals).....	15	10.8 Pressure overboots.....	34
3.7 External utility control (J13).....	15	<b>11. GENERAL CHARACTERISTICS OF THE DISTRIBUTION SYSTEM</b>	<b>36</b>
3.8 Cumulative alarm relay (J14).....	15	11.1 Atomising head.....	36
3.9 Alarm inputs from external devices.....	16	11.2 Assembly kit.....	36
3.11 Enable wash water line on external signal.....	16	<b>12. DESIGNING A SYSTEM</b>	<b>37</b>
3.12 Supervisor network.....	16	12.1 Sizing an MC system.....	37
3.13 Proportional 0 to 10 Vdc output .....	16	12.2 Sizing the compressor.....	37
<b>4. MASTER/SLAVE APPLICATIONS</b>	<b>17</b>	12.3 Sizing air/water lines between cabinet & distribution system .....	37
4.1 Applications for one large space or AHU (single point).....	17	<b>13. INSTRUCTIONS FOR INSTALLATION IN ROOMS</b>	<b>39</b>
4.2 Applications for multiple spaces or AHUs (multizone) .....	17	13.1 Tips for correct installation .....	39
4.3 Setting the serial address for units with multiple slaves.....	17	13.2 Assembling the atomising head.....	39
4.4 pLAN network connection (J11).....	18	13.3 Positioning the humidity probes.....	39
<b>5. STARTING AND USER INTERFACE</b>	<b>19</b>	13.4 Important rules to be followed .....	39
5.1 Starting .....	19	<b>14. INSTRUCTIONS FOR INSTALLATION IN DUCTS</b>	<b>41</b>
5.2 Stopping.....	19	14.1 Positioning the atomisation manifold.....	41
5.3 First start-up (setting the language).....	19	14.2 Important rules to be followed .....	42
5.4 Keypad .....	19	14.3 Positioning the humidity probes.....	42
5.5 "Main" screen.....	19	14.4 Manifolds for installation in ducts.....	42
5.6 "INFO" screens (read-only).....	20	<b>15. MAIN ADJUSTMENTS</b>	<b>43</b>
5.7 "SET" screen .....	20		
5.8 "pLAN" screen .....	20		
5.9 Main menu .....	21		
<b>6. USER MENU</b> 	<b>22</b>		
6.1 Alarm thresholds .....	22		
6.2 Clock .....	22		
6.3 Enable scheduler.....	22		
6.4 Set scheduler .....	22		
6.5 Weekly scheduler .....	22		

<b>16. MAINTENANCE</b>	<b>44</b>
16.1 Maintenance procedures .....	44
16.2 Kits & optional accessories for the air/water line (see chap. 2).....	44
16.3 Kits & optional accessories for the atomising heads (see chap. 11) .....	44
16.4 Spare parts for air/water line (see paragraph 1.4) .....	45
16.5 Pre-programmed pCO <sup>3</sup> controllers .....	46
16.6 Electrical panel kit and spare parts (see paragraph 1.4).....	46
<b>17. TROUBLESHOOTING</b>	<b>47</b>
17.1 Troubleshooting table.....	47

# 1. INTRODUCTION AND ASSEMBLY

## 1.1 MCmultizone atomising humidifier

Humidification system designed for medium/large installations, where a large humidification capacity is required with low energy consumption (high water flow without excessive energy costs).

Water and air, suitably regulated in terms of flow-rate and pressure, are delivered to the atomising nozzles in two separate lines. Due to the special shape of the nozzles, the jet of water is nebulised into a mist of very fine droplets (5 to 8 microns).

The atomised water can then easily change state and vaporise. The energy required for this transformation is supplied by the ambient air. For each litre/hour of water that vaporises, in fact, the environment gives up around 590 kcal (149 SkJ) of energy. Consequently, there is a decrease in temperature in the environment being humidified, and this process may be useful in many applications (adiabatic cooling). A timed automatic system ensures the atomising nozzles are cleaned periodically, preventing debris or scale from causing malfunctions.

Each atomising head is fitted with a small piston for cleaning any deposits, whenever the control cabinet stops operating. The system guarantees optimal atomisation at all times and prevents dripping when the installation is off. The electronic controller ensures the ambient humidity is kept at the required value, showing the relative humidity read in the room on the display.

The MCmultizone system is essentially made up of: control cabinet and compressed air-water supply, atomising nozzles, nozzle assembly kit.

## 1.2 Models

The MCmultizone humidifiers are available by:

- size: with maximum flow-rate of 60 l/h (MC060\*), or 230 l/h (MC models230\*);
- type of capacity modulation: ON/OFF (MC models\*\*\*C\*), or proportional (MC models\*\*\*H\*);
- power supply: single-phase 230 Vac 50 Hz (MC models\*\*\*\*D\*), or 110 Vac 60 Hz (MC models\*\*\*\*1\*);
- version: Master (MC models\*\*\*\*\*M\*), or Slave (MC models\*\*\*\*\*S\*);
- type of water used: mains, drinking (MC models\*\*\*\*\*0), or demineralised/aggressive (MC models\*\*\*\*\*1).

### Models recommended for specific applications:

- for duct applications (or air handling units), proportional units with high humidity limit probe are recommended.
- for applications directly in the room, both ON/OFF and proportional control units are recommended

## 1.3 Dimensions and weights

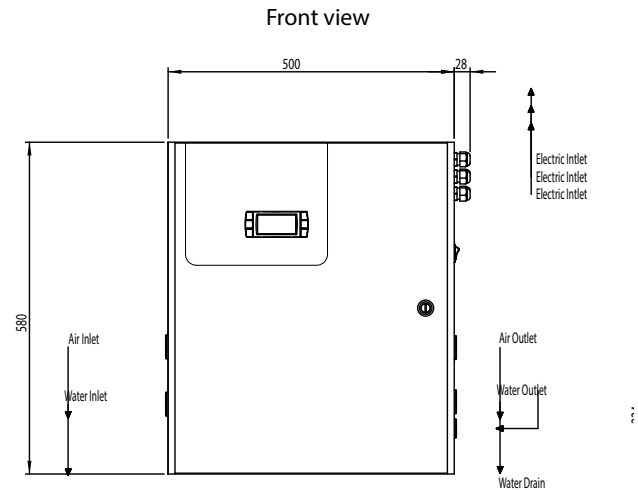

detail of the cabinet, side view, water and air inlet

detail of the cabinet, side view, outlet (to nozzles)

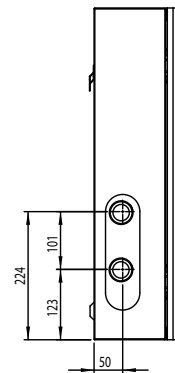
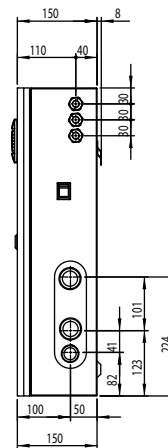

### Packaging dimensions:

- height (H): 770 mm (30.14 inch);
- width (W) 605 mm (23.82 inch);
- depth (D) 255 mm (10.00 inch).

### Packaged humidifier weight:

- models MC\*\*H(D,1)\*0\*: 21 kg (46.3 lb);
- models MC\*\*C(D,1)\*0\*: 20.5 kg (45.2 lb).

### Installed humidifier weight:

- models MC\*\*H(D,1)\*0\*: 19.5 kg (43 lb);
- models MC\*\*C(D,1)\*0\*: 19 kg (42 lb).

### Mechanical specifications:

- Installation: wall mounting;
- IP40;
- cabinet operating conditions: 1 to 40 °C (34 to 104 °F) <80 % rH non-condensing;
- storage conditions: 1 to 50 °C (34 to 122 °F) <80 % rH non-condensing.

cabinet

distribution

maintenance

### 1.4 Components

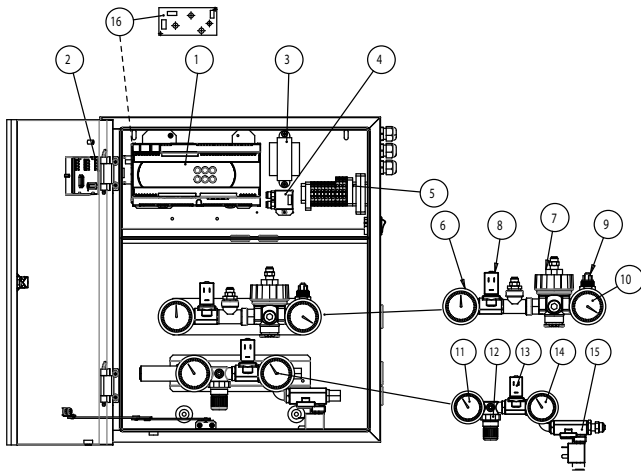

Key:

1. Electronic controller
2. Terminal (Master version only)
3. Transformer (CAREL code MCKTR000000)
4. Modulating valve regulator (modulating version only, CAREL code MCKARVA000)
5. Terminal block (fuse kit MCKFUSE000)
6. Air inlet pressure gauge
7. Air pressure regulator/regulator
8. NC air solenoid valve
9. Air line pressure switch (ON/OFF versions only)
10. Air outlet pressure gauge
11. Water inlet pressure gauge
12. Water pressure regulator
13. NC water solenoid valve
14. Water outlet pressure gauge
15. NO water drain solenoid valve
16. Power supply 110/230 Vac 12 Vdc 0.5 A (modulating version only, CAREL code MCKAL00000)

### 1.5 Electrical specifications

#### Models MC\*\*\*\*D\*\*\* (230 V 50 Hz) <sup>(1)</sup>

	MC***CD*00	MC***CD*01	MC***HD*00	MC***HD*01
Vac	230 V	230 V	230 V	230 V
phases	1	1	1	1
Hz	50/60 Hz	50 Hz	50/60 Hz	50 Hz
Power	37 W	44 W	41 W	48 W
Current	0.26 A	0.29 A	0.30 A	0.33 A

<sup>(1)</sup> Product in compliance with EN55014, EN61000, EN60335

#### Models MC\*\*\*\*1\*\*\* (110 V 60 Hz) <sup>(1)</sup>

	MC***C1*00	MC***C1*01	MC***H1*00	MC***H1*01
Vac	110 V			
phases	1			
Hz	60 Hz			
Power	37 W	44 W	41 W	48 W
Current	0.54 A	0.60 A	0.64 A	0.70 A

<sup>(1)</sup> Product approved to UL998 & CSA C22.2 No104

### 1.6 Opening the packaging



make sure the humidifier is intact upon delivery and immediately notify the transporter, in writing, of any damage that may be due to careless or improper transport;  
 move the humidifier to the site of installation before removing from the packaging, grasping the neck from underneath;  
 open the cardboard box, remove the protective material and remove the humidifier, keeping it vertical at all times.

### 1.7 Positioning the cabinet

The humidifier should be positioned so as to guarantee the following:



- reading the values on the display;
- access to the keypad on the display;
- opening the front panel;
- access to the inside parts for checks and maintenance;
- connection of the air and water supply lines;
- connection of the air and water distribution lines;
- power and control connections;



**Important:** the drain hose must be connected directly to a drain located at least 50 mm below the level of the atomising nozzles

### 1.8 Wall mounting

Fasten the humidifier to a solid support surface using the screws and bracket supplies.

Make sure there is enough space to connect the air and water inlet and outlet lines.

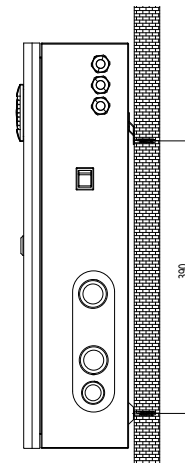



rear of the cabinet

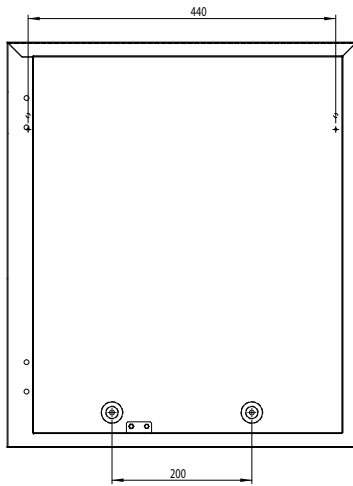

drilling template

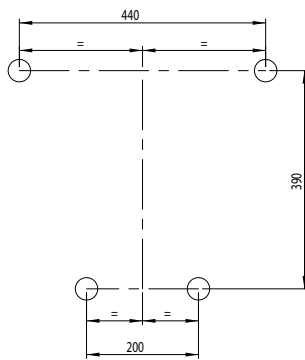

### 1.10 Components and accessories

Once having opened the front cover of the humidifier, make sure the following are included:



kit of screws with plugs for wall-mounting;



PG13 cable glands for the electrical connections

cabinet

distribution

maintenance

### 1.9 Opening the cabinet door

1. press and turn anticlockwise using a flat-head screwdriver (max 8 mm) until releasing the door;
2. open the door on the cabinet by swinging to the left.

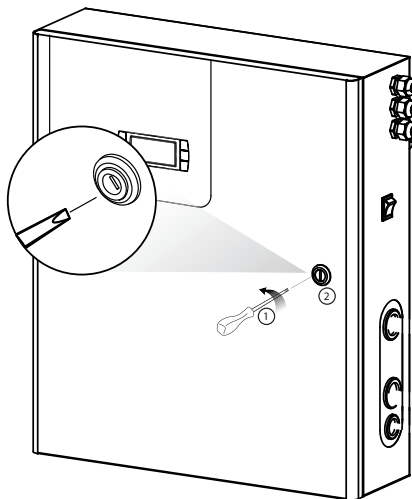

## 2. WATER AND AIR CONNECTIONS

**! Important:** before proceeding, disconnect the humidifier from the power supply.

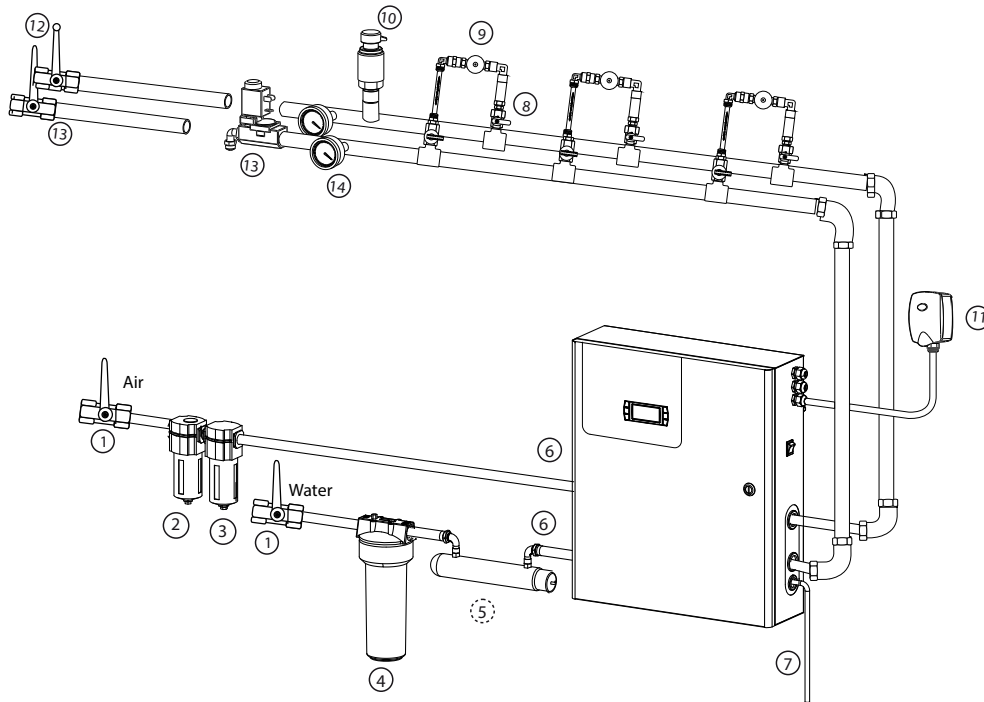

### Connections:



1. Install two manual valves upstream of the installation to allow the air and water lines to be isolated (not supplied by CAREL).
2. Install an oil filter (CAREL code MCFILOIL01) to remove particles of oil from the compressed air
3. Install a 5 micron air filter (CAREL code MCFILAIR01) upstream of the cabinet to solid particles from the compressed air.
4. Install a 5 micron water filter (CAREL code MCC05PP005 and the filter casing code MCFILWAT05) to remove solid particles from the supply water.
5. Optional: install a UV lamp to sanitise the water (CAREL code MCKSUV00000). The lamp has an external 230 V 50 Hz power supply. These UV lamps are used to eliminate any bacteria from the supply water.
6. Install the air and water lines
7. Prepare a hose at least 50 mm below the level of the atomising nozzles to drain the water remaining in the lines when the installation is in standby or off.
8. Atomising nozzle assembly kit for rooms and ducts (CAREL code MCK1AW0000)
9. Atomising nozzles (for the models see par. 11)
10. Optional, install one of the following components:
  - pressure gauge at the end of the air line (CAREL kit code MCKMA04000) to display the pressure at the end of the line;
  - a pressure probe at the end of the line (for the codes of the probes see Chap. 16.2 "Maintenance") to measure and display the pressure at the end of the line on the humidifier display
11. Install the humidity probes (for the codes of the CAREL probes see Chap. 16.2 "Maintenance")
12. Install a manual valve at the end of the air line.
13. Install one of the following two valves:
  - manual valve at the end of the line (not supplied by CAREL).
  - drain solenoid valve (CAREL code MCKDVWL000 or code MCKDVWL001) to perform the "drain", "fill", and "washing" functions (see par. 10.5 "Operating principles").
14. Optional, install a pressure gauge at the end of the water line (CAREL code. kit MCKMW02501) to display the pressure at the end of the water line

### Fittings provided for the water connections:

side view, water & air inlet

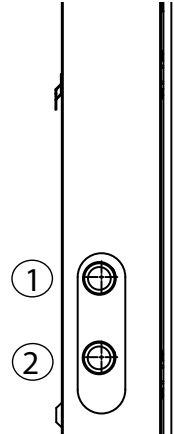

side view, outlet (to nozzles)

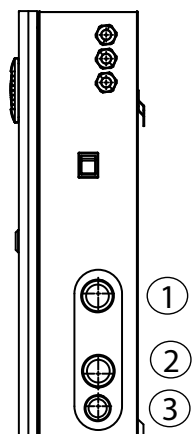

### Key:

1. air inlet and outlet
2. water inlet and outlet
3. drain water outlet

## 2.1 Characteristics of the water line

	Models			
	MC060*D*0*	MC060*1*0*	MC230*D*0*	MC230*1*0*
max flow-rate (l/h, lb/h, G/d)	60 l/h 130 lb/h 380G/d	60 l/h 130 lb/h 130 lb/h	230 l/h 500 lb/h 1450 G/d	230 l/h 500 lb/h 1450 G/d
inlet pressure (Mpa,Bar,PSI)	0.3 to 0,7 Mpa 3 to 7 Bar 40 to 100 PSI			
temperature	1 to 50 °C / 34 to 122 °F			
inlet	G1/2°F	NPT1/4°F	G1/2°F	NPT1/4°F
outlet	G1/2°F	NPT1/2°F	G1/2°F	NPT1/2°F
drain	TCF 8/10	NPT1/4°F	TCF 8/10	NPT1/4°F

## 2.2 Type of supply water

- ☺ demineralised water by osmosis;
- ☹ drinking water ((however more dust in the room and more frequent maintenance and cleaning the nozzles);
- ☹ softened water (the mineral content dissolved in the water is not reduced).

recommended supply water characteristics	unit of measure	limits	
		min.	max.
pH		6.5	8.5
Specific conductivity at 20 °C ( $\sigma_{R, 20^{\circ}C}$ )	$\mu S/cm$	0	50
Total hardness (TH)	mg/l CaCO <sub>3</sub>	0	25
Temporary hardness	mg/l CaCO <sub>3</sub>	0	15
Total dissolved solids (cR)	mg/l	(!)	(!)
Dry residue at 180° (R180°C)	mg/l	(!)	(!)
Iron + Manganese	mg/l Fe+Mn	0	0
Chlorides	ppm Cl	0	10
Silicon dioxide	mg/l SiO <sub>2</sub>	0	1
Chlorine ions	mg/l Cl <sup>-</sup>	0	0
Calcium sulphate	mg/l CaSO <sub>4</sub>	0	5

(!)= values depend on the specific conductivity; in general:

$$C_R \approx 0,65 * \sigma_{R, 20^{\circ}C}; R_{180} \approx 0,93 * \sigma_{R, 20^{\circ}C}$$

**! Important:** the supply water must comply with the requirements of UNI 8884 UNI 8884 standard, "Characteristics and treatment of the water in cooling and humidification circuits". According to this standard, the humidifier must be supplied with water that, as well as being drinkable (EC directive 98/83), must remain within the following limits:

- electrical conductivity <100  $\mu S/cm$ ;
- total hardness <5 °fH (50 ppm CaCO<sub>3</sub>);
- 6.5 < pH < 8.5;
- chloride content <20 mg/l;
- silica content <5 mg/l;
- conductivity less than 30  $\mu S/cm$  (it is recommended to use the MC cabinet in the version for aggressive water).

Similar requirements are also specified in the European reference standards VDI6022, VDI3803.

Upstream of the cabinet, connect the following to the water line:

- a water filter with a filter size no greater than 5 microns (filters available upon request).
- an expansion vessel (not supplied by Carel SpA) with a capacity of several litres, to avoid water hammer that may damage the installation.

The water line is tested, and checked at a pressure of 0.35 bars downstream of the cabinet.

## 2.3 Characteristics of the air line

	Models			
	MC060*D*0*	MC060*1*0*	MC230*D*0*	MC230*1*0*
inlet pressure (Mpa,Bar,PSI)	0.5 to 0.7 Mpa 5 to 7 Bar 80 to 100 PSI			
temperature	1 to 50 °C / 34 to 122 °F			
inlet	G1/2°F	NPT1/2°F	G1/2°F	NPT1/2°F
outlet	G1/2°F	NPT1/2°F	G1/2°F	NPT1/2°F

## 2.4 Type of compressed air

**YES** | dry and oil-free air

Upstream of the cabinet connect the following devices (available upon request):

- a 5 micron filter upstream of the cabinet.
- a filter to remove oil and particles upstream of the 5 micron air filter

The air line is tested, and checked at a pressure of 2.1 bars downstream of the cabinet.

## 2.5 Type of water and air lines

**YES** | copper pipes (mains drinking water only), plastic hoses, polypropylene hoses: ensure faster and simpler connections by welding.

**NO** | galvanised steel pipe: may lead to the detachment of impurities, and cause blocking or damage to the nozzles.

**! Important:** Apply sealant to the joints of the pipes and hoses running to the atomising nozzles (preferably Teflon or liquid Teflon).

## 2.6 Water and air line accessories

code	description	fittings	reference dwg. page 10
MCFILOIL01	3/8" oil filter for air	G3/8°F in /out	2
MCFILAIR01	1/2" air filter	G1/2°F in /out	3
MCFILWAT05	5" water filter container	G1/2°F in /out	4
MCKSUV0000	UV sanitising kit	G1/4°F in /out	5
MCKPT**000	pressure transducer	G1/4" M	10 a
MCKMA04000	air outlet pressure gauge 0 to 4 bars	G1/4" M	10 b
MCKDVWL00*	NO solenoid valve at end of line	G1/4" F in /out	13
MCKMW02501	water outlet pressure gauge 0 to 2.5 bars	G1/4" M	14

### 3. ELECTRICAL CONNECTIONS

cabinet

distribution

maintenance

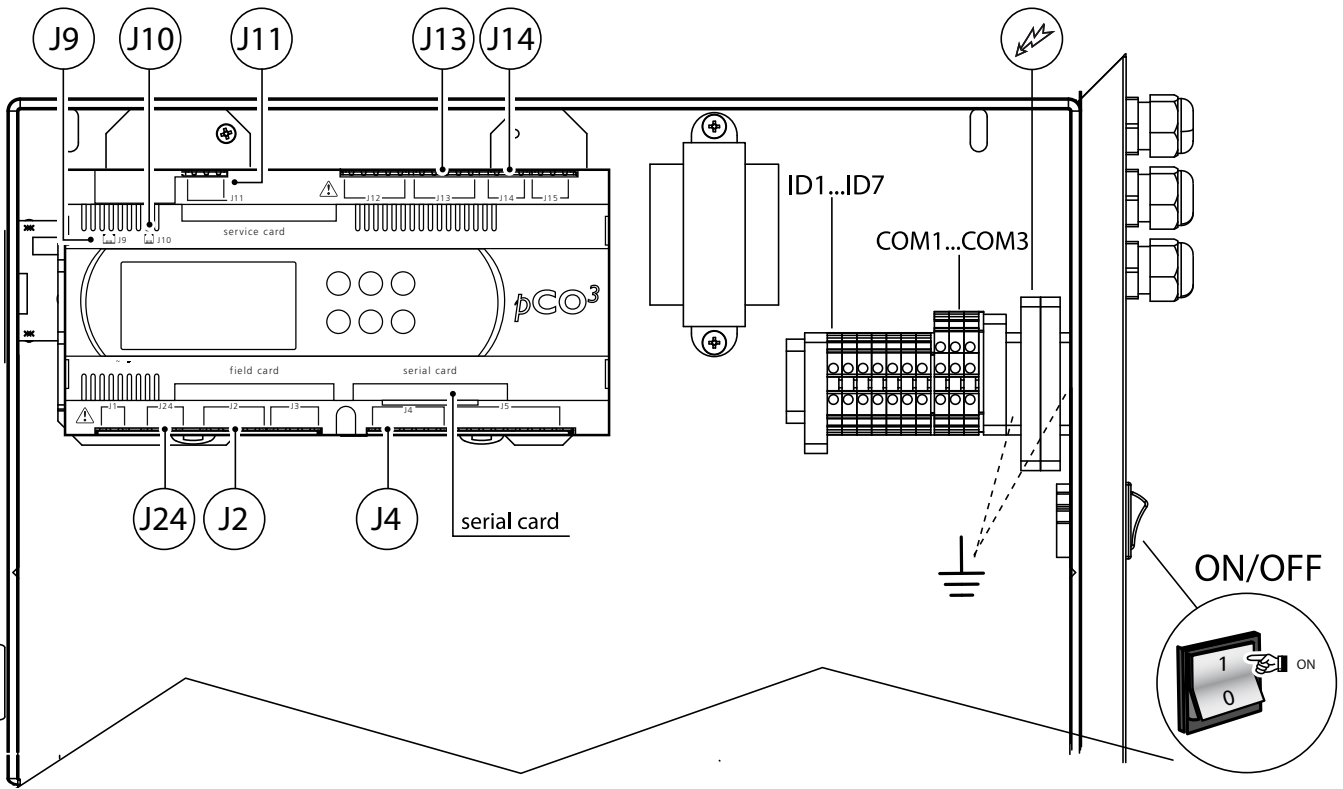

**Wiring**



**Important:**

- make sure that the cable glands are applied;
- to avoid interference, separate the power cables from the probe/external signal cables.



**Power supply**



**Important:** install a power switch outside the humidifier to completely isolate the mains power supply.

ID1...ID7  
COM1...COM3

**Digital Input**

Control signals from external voltage-free contact i.e. ON/OFF humidistat  
alarm input from external devices  
enable wash water line from external signal

J11

Connection for master/slave communication networks (pLAN)

J2

Control signals from humidity/temperature probes, external controller & air line pressure transducer

J13

External utility control

J14

Cumulative alarm relay

serial card

External supervisor systems

J24

Power supply for humidity/temperature probes and references for external controllers

J4

Proportional 0 to 10 Vdc output

**pCO3 terminal block**

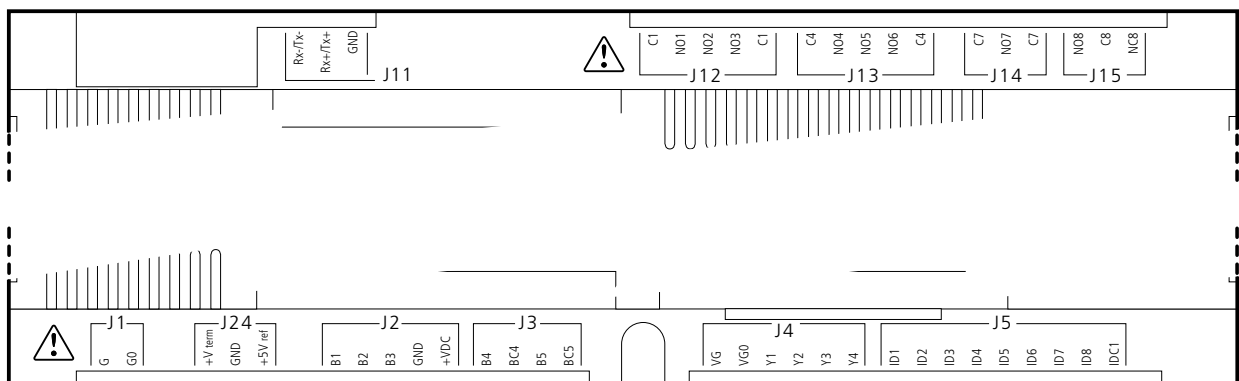

### 3.1 Power supply

Depending on the model:  
 MC\*\*\*\*D\*\*\* voltage 230V 1~ 50Hz  
 MC\*\*\*\*1\*\*\* voltage 110V 1~ 60Hz

**Important:** The cables must be shielded and conform to local standards. Install a power switch outside the humidifier to completely isolate the mains power supply.

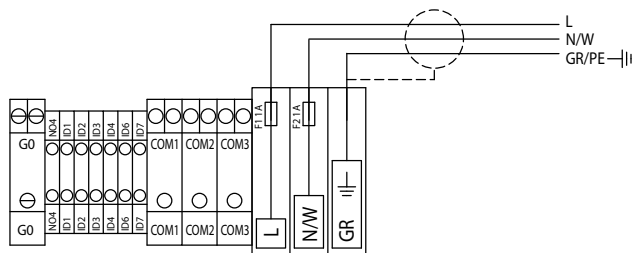

Connections:

MC cabinet	Power cable
L	L/F (phase)
N	N/W (neutral)
GR	GR/PE (earth)

### 3.2 Remote ON/OFF (ID & COM)

Use two-wire shielded cable, AWG20/22

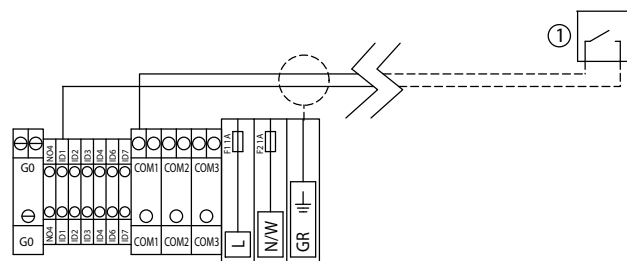

① Remote ON/OFF

Connections:

MC cabinet	Remote ON/OFF
ID1	NC/NO
COM (1 or 2 or 3)	CON
GR	shield

### 3.3 Modulating control signal (J24 & J2)

The input control signal connections depend on the control algorithm activated.

cables	up to 30 m: shielded cables, size 0.5 mm <sup>2</sup> (AWG20) over 30 m: shielded cables, size 1.5 mm <sup>2</sup> (AWG15) connect the shield (cabinet side) to specific earth terminal GR (see connection diagrams)
the signal can come from	a. modulating control with external controller b. modulating control with ambient humidity probe c. external controller & limit humidity probe d. ambient humidity probe & limit humidity probe e. modulating control with temperature control f. mod. control with temperature control & limit probe

To set the type of operation, control and signal:  
 installer menu > type of control (see chap. 7).

#### a. Modulating control with external controller

0 to 1V 0 to 10V 2 to 10V 0 to 20 mA 4to20mA

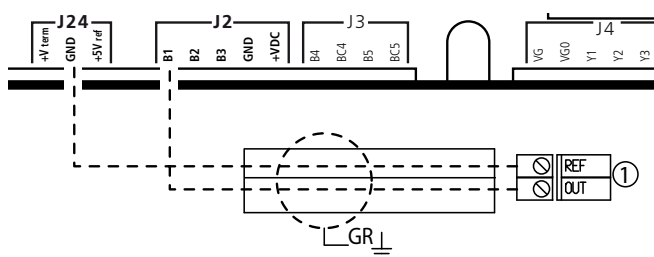

① External controller

Connections:

MC cabinet		external controller
J24	GND	REF
J2	B1	OUT

#### b. Modulating control with ambient humidity probe

0 to 1V 0 to 10V 2 to 10V 0 to 20 mA 4to20mA

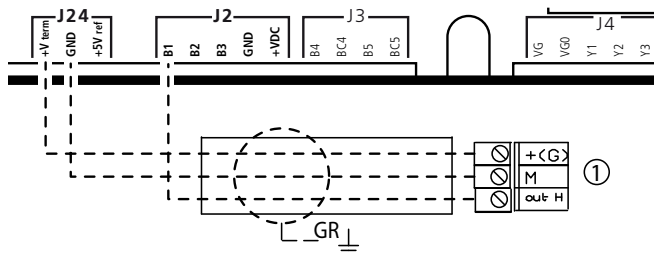

① Ambient humidity probe

Connections:

MC cabinet	ambient humidity probe	
J24	+V term	+(G)
	GND	M
J2	B1	out H

#### c. Modulating control with external controller and limit probe

0 to 1V 0 to 10V 2 to 10V 0 to 20 mA 4to20mA

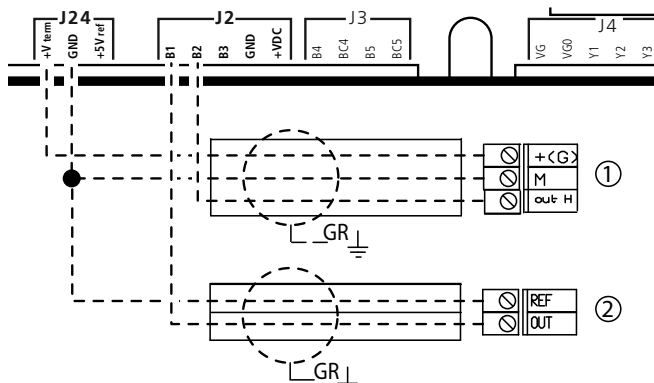

① Limit humidity probe ② External controller

Connections:

	MC cabinet	limit humidity probe	external controller
J24	+V term	+(G)	-
	GND	M	REF
J2	B1	-	OUT
	B2	out H	-

**d. Mod. control with ambient probe & limit probe**

0 to 1 V 0 to 10V 2 to 10V 0 to 20 mA 4to20mA

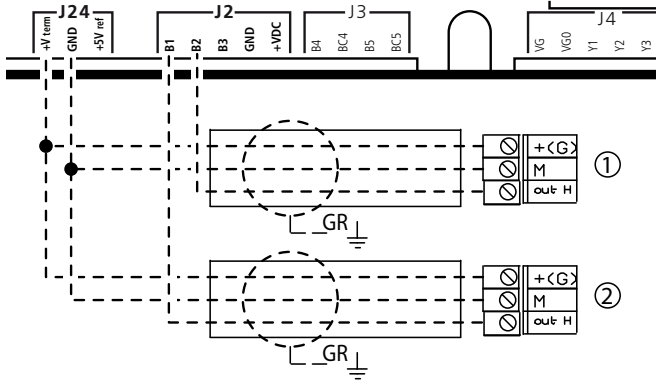

Ⓛ Limit humidity probe Ⓜ Ambient humidity probe

Connections:

	MC cabinet	limit humidity probe	amb. humidity probe
J24	+V term	+(G)	+(G)
	GND	M	M
J2	B1	-	out H
	B2	out H	-

**e. Modulating control with temperature control**

0 to 1 V 0 to 10V 2 to 10V 0 to 20 mA 4to20mA NTC

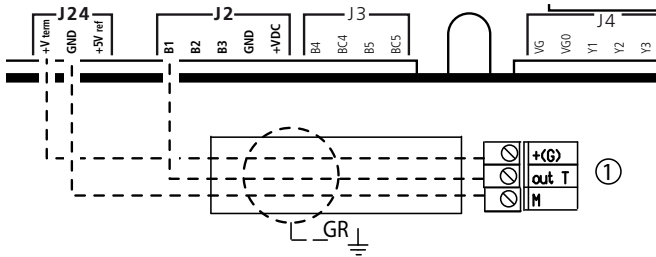

Ⓛ Ambient temperature probe

Connections:

	MC cabinet	Ambient temperature and limit humidity probe
J24	+V term	+(G)
	GND	M
J2	B1	out T

or

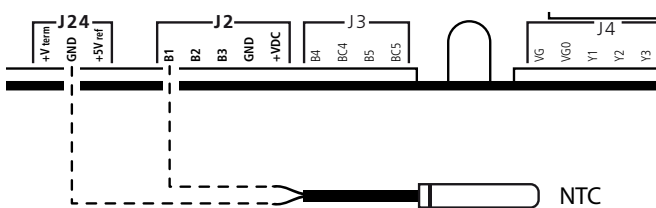

**f. Modulating control with temperature control and humidity limit probe**

0 to 1 V 0 to 10V 2 to 10V 0 to 20 mA 4to20mA NTC

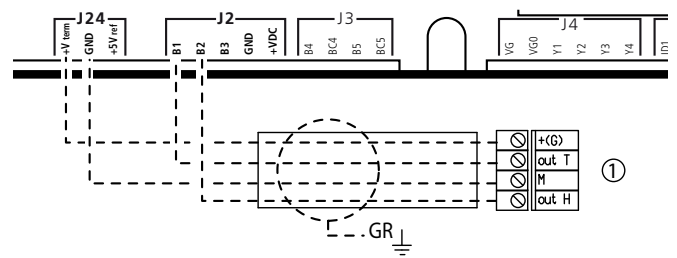

Ⓛ Ambient temperature and limit humidity probe

Connections:

	MC cabinet	Ambient temperature and limit humidity probe
J24	+V term	+(G)
	GND	M
J2	B1	out T
	B2	out H

Or:

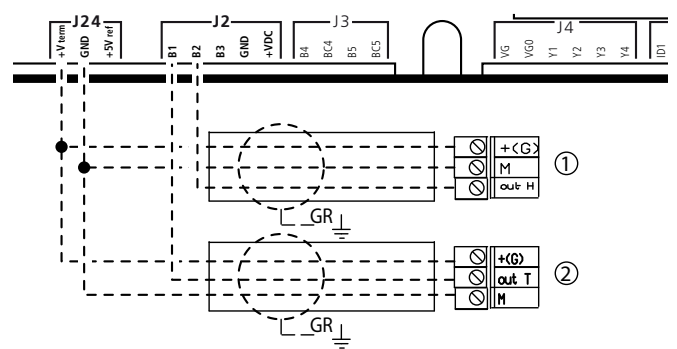

Ⓛ Limit humidity probe Ⓜ Temperature probe

Connections:

	MC cabinet	(1) limit hum. probe	(2) temperature probe
J24	+V term	+(G)	+(G)
	GND	M	M
J2	B1	-	out T
	B2	out H	-

**3.4 Control signals from ext. voltage-free contact i.e. ON/OFF humidistat (ID & COM)**

Cables: up to 30 m: shielded cables, size 0.5mm<sup>2</sup> (AWG20)  
over 30 m: shielded cables, size 1.5 mm<sup>2</sup> (AWG15)

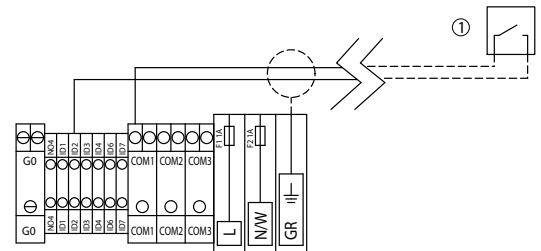

Contact open: MC unit off  
Contact closed: MC unit on

Ⓛ ON/OFF humidistat

MC cabinet	ON/OFF humidistat
ID2	ON/OFF
COM1	COM
GR	shield

### 3.5 Control signals from air line pressure transducer (J2)

**Transducer:** CAREL (for the codes of the probes see chap. 16.2 "Maintenance") -0 to 4 bars/ 4 to 20 mA (-11 to 60 psi). Supplied with cable in different lengths, depending on the code (10 m, 50 m, 100 m)

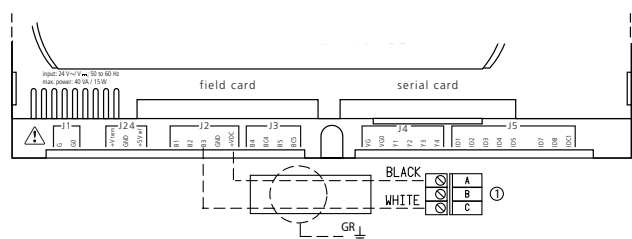

① Pressure probe

**Connections:**

MC cabinet		cable	pressure probe
J2	B3	white	C
	GR	shield	-
	+VDC	black	A

### 3.6 Connection of NO drain solenoid valve at end of water line (group of ID terminals)

<b>NO solenoid valve (normally open):</b>	CAREL code MCKDVWL000 or code MCKDVWL001 (20 VA 24 Vac)
<b>Recommended connection cables</b>	up to 100 m: shielded cables, size 1.5 mm <sup>2</sup> (AWG1.5) up to 200 m: shielded cables, size 2.5 mm <sup>2</sup> (AWG13)
<b>Electrical specifications of the contact</b>	power 500 VA voltage 250 V current 2 A resistive/inductive

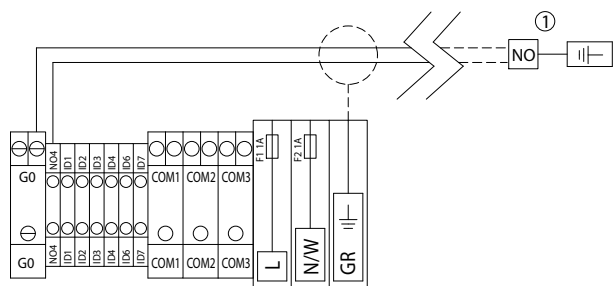

① NO solenoid valve (normally open) water line

**Connections:**

MC cabinet		solenoid valve
G0		1
NO4		2
GR		4

### 3.7 External utility control (J13)

<b>Cable</b>	shielded AWG 15/20	
<b>Control to interface MC with:</b>	compressors water treatment systems	
<b>Electrical specifications of the contact</b>	power 500 VA voltage 250 V current 2 A resistive/inductive	
<b>Status of the contact in function of MC status:</b>	MC cabinet OFF or in standby	contact open
	cabinet with production request	contact closed

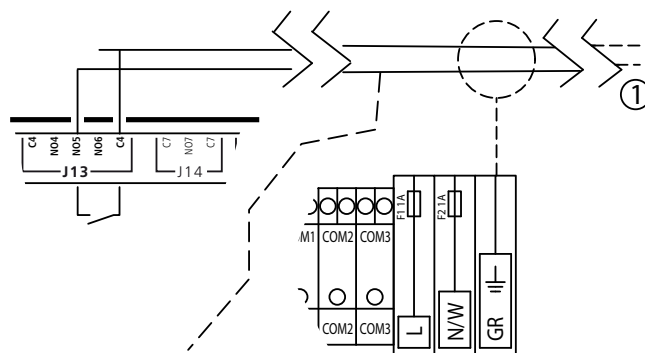

① Start compressor / water treatment

**Connections:**

MC cabinet		Output
J13	NO5	ON/OFF
	C4	COM
GR		shield

### 3.8 Cumulative alarm relay (J14)

Activated when one or more alarms is detected via a contact/output that can be transferred to a supervisory system

<b>Cable</b>	shielded AWG 15/20	
<b>Electrical specifications of the relay</b>	power 500 VA voltage 250 V current 2 A resistive/inductive	
<b>Status and operation of the relay:</b>	contact open	no active alarms
	contact closed	active alarm/alarms

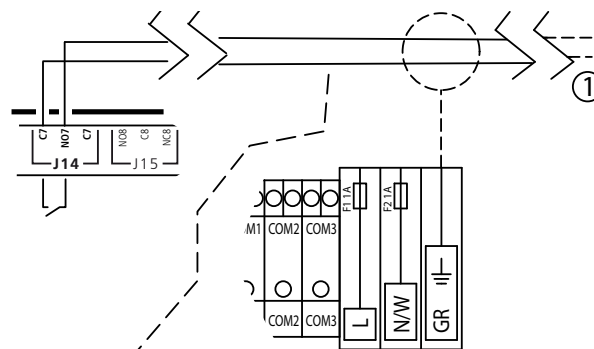

① Alarm relay

**Connections:**

MC cabinet		Output
J14	C07	COM
	NO7	ON/OFF
GR		shield

### 3.9 Alarm inputs from external devices

Inputs for signalling the status of external devices such as:	air flow sensor air compressor alarm water treatment system alarm
Cable:	shielded AWG 15/20
Configuration of type of contact:	see installer menu > external alarms
Connections:	water treatment system contacts: ID3 & COM1 air compressor contacts: ID4 & COM1 air flow switch contacts: ID6 & COM2

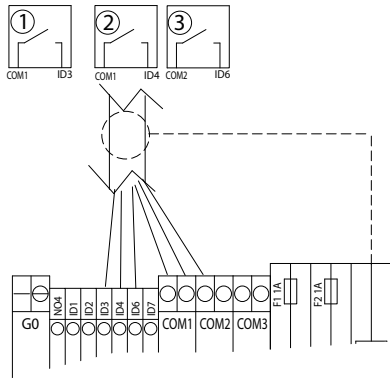

- ① Alarm relay from water treatment
- ② Compressor alarm relay
- ③ Flow switch alarm relay

**Connections:**

MC cabinet	Relay
ID3	ON/OFF
COM1	COM
ID4	ON/OFF
COM1	COM
ID6	ON/OFF
COM2	COM
GR	shield

### 3.11 Enable wash water line on external signal

Manages the washing of the water line based on an external signal. To do this, set: installer menu > operating options > valve at the end of the line (YES) > special functions > wash > manual

Cable:	shielded AWG 15/20
Status and operation of the contact:	contact open wash line not enabled externally contact closed wash line enabled externally

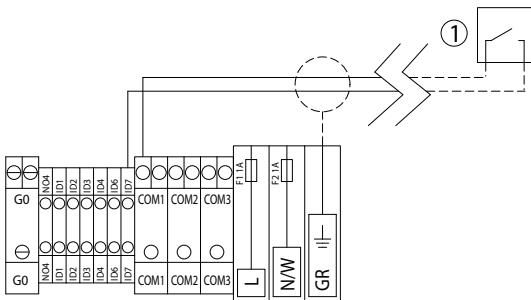

- ① External contact for activating the wash function

**Connections:**

MC cabinet	Relay for activating wash on ext. signal
ID7	ON/OFF
COM1	COM

### 3.12 Supervisor network

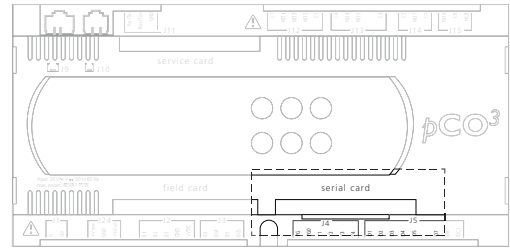

**CAREL optional cards**

	network/card	protocol supported
PCOS004850	RS485	CAREL, Modbus®
PCO100MDM0	RS232 (external modem)	CAREL for remote connections
PCO1000WB0	Ethernet™	TCP/IP SNMP v1 & v2c BACnet™ Ethernet™ ISO8802-2/8802-3 BACnet/IP
PCO1000F0	LON in FTT10 (*)	LON-Echelon
PCO1000BA0	Ethernet™ (Modbus®)	BACnet™ MS/TP

(\*) When suitably programmed

**⚠ Important:** Follow the instructions provided with the optional cards as regards the technical specifications, connections and expansions.

### 3.13 Proportional 0 to 10 Vdc output (J4)

Parallel output to the 0 to 10 Vdc signal sent to the proportional valve.

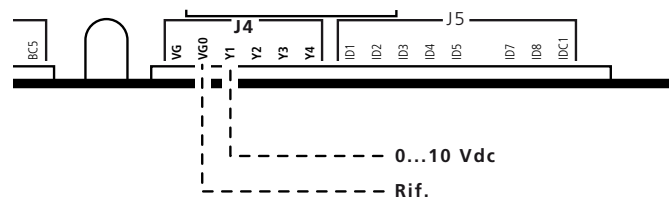

MC cabinet	Outputs
VG0	REF.
Y1	0 to 10 Vdc

Output specifications: maximum load 1 kΩ (10 mA)



## 4. MASTER/SLAVE APPLICATIONS

- **MC master cabinet:** unit fitted with display to manage the operation of the unit itself and the other units connected
- **MC slave cabinet:** unit without display that normally works based on the controls received from the master
- **pLAN:** serial communication system to connect the master unit to the slaves across a local network
- **each master unit can be connected to up to 5 slave units**
- **serial address:** numeric code that automatically identifies each unit cabinet in the installation. Master unit: address 1, Slave unit: address 2. The serial address is already stored in the controller on the unit, and should only be modified on the Slave unit when there are multiple units (see paragraph 4.3)
- for the software configuration of the pLAN network, see **installer menu > pLAN configuration**

### 4.1 Applications for one large space or AHU (single point)

- Ideal for large rooms (or air handling units) where the required water capacity exceeds the output of a single MC cabinet.
- Only the master unit is fitted with a probe, and the values saved are applied to all the units connected.

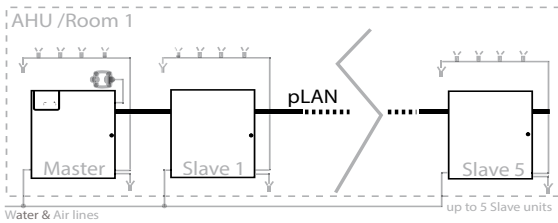

AHU - Air Handling Unit

### 4.2 Applications for multiple spaces or AHUs (multizone)

- Ideal for applications in a series of separate rooms (or air handling units).
- Each MC cabinet is fitted with a probe, the values saved by each probe are managed by the cabinet this is connected to.
- To ensure continuity of operation in the event of interruption of the serial communication see installer menu > type of control > stop slave offline.

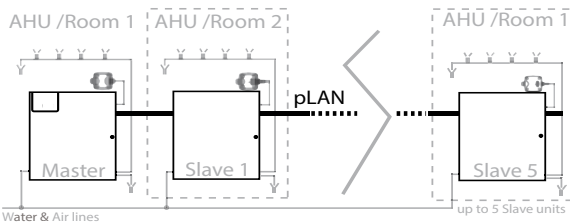

AHU - Air Handling Unit

### 4.3 Setting the serial address for units with multiple slaves

- The serial address is used to automatically identify each MC unit in the installation.
- The address is already configured: for the master unit=1; for the slave unit=2.
- The slave units do not have terminals.
- In systems with a series of slaves, the serial address must be changed to avoid having the same address (2) on all the units (causing conflict in the event of pLAN communication).
- To set the pLAN address, use the kit PGD0002F0K.

**! Important:** The serial addresses must be changed before connecting the pLAN network.

Instructions for changing the serial address on the slave units using the kit PGD0002F0K:

- complete the power supply connections (see paragraph 3.1);
- switch off the MC cabinet (make sure the power supply is disconnected);
- connect the cable in the terminal kit to output J10 on the cabinet
- switch the cabinet on;
- press the ALARM and UP buttons together until the display shows the message "self test please wait" (displayed for a few seconds, before the address setting screen) ;
- set the required address using UP or DOWN (to a value higher than 2) and press ENTER to confirm and exit;
- the MC slave unit has now been configured with a new serial address, switch the unit off, disconnect the cable and repeat for the other units.

Once configuration has been completed, connect the pLAN serial line (see the following paragraph)

**! Important:** only change the serial address on the slaves, and not on the master.

Table of serial addresses (installer's responsibility, see installer menu > pLAN configuration):

unit	unit name	room or AHU	serial address
master	.....	.....	1
slave 1	.....	.....	.....
slave 2	.....	.....	.....
slave 3	.....	.....	.....
slave 4	.....	.....	.....
slave 5	.....	.....	.....

cabinet

distribution

maintenance

### 4.4 pLAN network connection (J11)

Use two-wire cables plus earth, AWG 20/22, maximum distance between two cabinets: 200 m (219 yd).

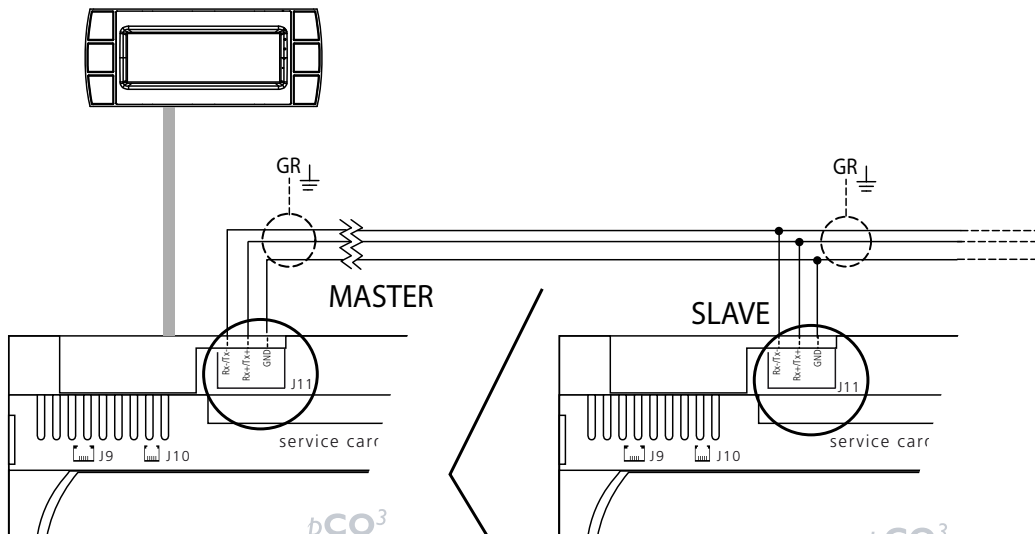

Connections:

MC Master cabinet J11		MC Slave cabinet	
J11	RX+/TX+	J11	RX+/TX+
	RX-/TX-		RX-/TX-
	GND		GND

In multizone mode, by disabling the "stop slave off line" function, if the pLAN is interrupted the slaves operate independently according to the signals from the probes or/and controllers. In this mode, the values will not be shown on the master display.

cabinet

distribution

maintenance

## 5. STARTING AND USER INTERFACE

Before starting the humidifier, check:



- water and air connections (chap. 2). In the event of water leaks do not start the humidifier before having resolved the problem;
- electrical connections (chap. 3)

### 5.1 Starting



### 5.2 Stopping

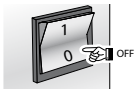

**Note:** if the system is stopped for an extended time, open the valve at the end of the water line to assist drainage. If the system is fitted with drain solenoid valves at the end of the line (optional), this is done automatically.

### 5.3 First start-up (setting the language)

On power-up, the following screen is displayed:

```
Select language:
1. English
2. Italiano
3. Deutsch
4. Francais
5. Espaniol
```

Press ENTER to go the list of languages, then UP to select the desired language and ENTER to confirm. This screen remains displayed for 60 seconds.

Subsequently, the following screen will be displayed:

```
Show language mask at unit start-up Yes/No
```

- YES: the screen for choosing the language will be displayed when the humidifier is started the next time;
- NO: the screen for choosing the language will no longer be displayed on power-up.

**Note:** The language can also be changed from the maintenance menu (maintenance menu > system info > language).

### 5.4 Keypad

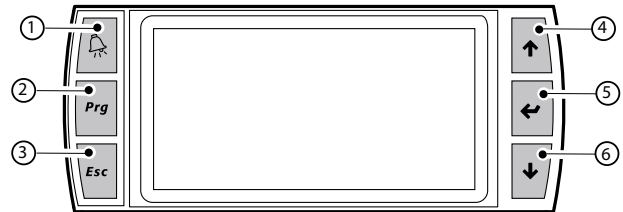

button	function
(1) alarm	list active alarms and reset any alarms present
(2) PRG	return to the "main" screen from the "main" screen access the main menu
(3) ESC	return to the previous screen/display
(4) UP	circular navigation inside the menus, the screens, the parameters and the values of the parameters from the "main" screen, access an "INFO menu"
(5) ENTER	select and confirm (like the "Enter" key on a computer keyboard) from the main menu, access the "SET" screen
(6) DOWN	circular navigation inside the menus, the screens, the parameters and the values of the parameters from the main screen, access the pLAN screens and connect to the SLAVE cabinets

### 5.5 "Main" screen

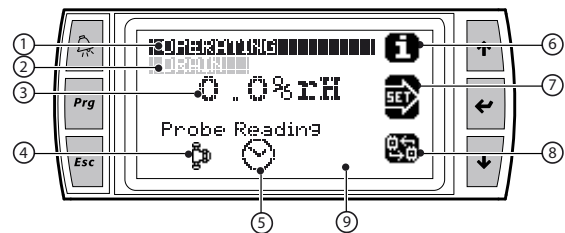

(1)	description of unit status (*)
(2)	line 2 description of unit status (**)
(3)	value read according to the type of signal connected
(4)	status of the atomising nozzles:
	atomising nozzles operating
	atomising nozzles off
(5)	time bands set
(6)	access the "INFO" screen (UP button)
(7)	access the "SET" screen (ENTER button)
(8)	access the "pLAN" screen (DOWN button)
(9)	Symbol on display: no image: master unit not connected to a network (stand alone)
	<b>MULTI ZONE</b> master unit connected to a pLAN network for multiple spaces
	<b>SINGLE ZONE</b> master unit connected to a pLAN network for single spaces
	<b>SLAVE UNIT</b> slave unit

(\*) Types of descriptions:

- IN OPERATION: atomised water production in progress,
- SHUTDOWN ALARM: production stopped due to an alarm,
- OFF FROM SUPERVISOR: production stopped by supervisor,
- OFF FROM SCHEDULER: production stopped during the set time band,
- OFF FROM REMOTE: production stopped due to opening of the "Remote ON/OFF" contact,
- OFF FROM KEYPAD: production stopped from the keypad (see "SET" screen),
- MANUAL MODE: manual mode activated (see maintenance menu)
- NO REQUEST: unit on without production request.

(\*\*) Types of unit status description, line 2:

- DRAIN: unit draining;
- FILL: unit filling the water line;
- CLEANING: unit cleaning the heads on the air line;
- WASHING: unit washing the water line.

### 5.6 "INFO" screens (read-only)

Series of read-only screens for displaying the main humidifier status values. To access, press UP from the "Main" screen. There are two "INFO" screens; to move from one screen to the next, press UP or DOWN. Press ESC to return to the "Main" screen.

Info (1/2)

	display	UOM
Request	50-100	%
Air line	ON/OFF	
Water line	ON/Drain	
Type of op..	ON/OFF or Modulating	
Press. sensor		bar/psi
Date & time	dd/mm/yy	00:00

Info (2/2)

	display	UOM
Humidifier model		
In production	YES/NO	
Hours production		h
Date & time	dd/mm/yy	00:00

### 5.7 "SET" screen

Used to set the main values for the humidifier.

From the main screen press:

- ENTER to access the menu;
- ENTER to move from one value to the next;
- UP & DOWN to modify the selected value;
- ENTER confirm and go to the next value.

Parameter	range	default	UOM
Set point	0 to 100	50	%rH- °C/°F
Humidifier	AUTO / OFF	OFF	-
Max. prod.	50 to 100	100	%
Prop. band	2 to 19.9	5	%rH- °C/°F
Limit set (limit probe set point)*	0 to 100	80	%rH
Prop. band*	2 to 19.9	5	%rH

\* visible only if the limit probe is enabled

### 5.8 "pLAN" screen

From the main screen press:

- DOWN to access the menu;
- ENTER to select the unit;
- UP & DOWN to move from one unit to the next;
- ENTER to confirm.

Units connected

1 (master)
2 (slave)
3 (slave)
4 (slave)
5 (slave)
6 (slave)
Current:
Network:

## 5.9 Main menu

To access press PRG from the main screen

Buttons:

- UP & DOWN: navigation inside the submenus, screens, and range of values and settings;
- ENTER: confirm and save the changes made;
- ESC: to go back (pressed repeatedly returns to the "Main" screen).

1. User (no password)	1. Alarm thresholds	Main probe thresholds High alarm Low alarm Limit probe thresholds High alarm Alarm delay
	2. Clock	Clock Hour Day Month Year Format Day
	3. Enable scheduler	Enable scheduler Scheduler On/Off Variable set point
	4. Set scheduler	Set scheduler P1-1 P1-2 P2 P3 P4
	5. Weekly scheduler	Weekly scheduler Monday Tuesday Wednesday Thursday Friday Saturday Sunday
	6. Scheduled setp.	Scheduled set points Z1 Z2 Z3 Z4
2. Installer (password 77)	1. Type of control	Type of operation Type of signal or probe Type of signal or probe Main Limit Unit of measure Stop slave offline
	2. Probe configuration	Main probe config. Min value Max value Offset Limit probe config. Min value Max value Offset
	3. Operating options	Operating options (1/2) Remote p. sensor Max. air press. Min air press. Max air press. offset Min air press. offset Operating options (2/2) Valve at end of line Alarm relay logic Prop. s. set point:
	4. Special functions	Special func. (1/3) Independent cleaning Enabled Period Duration Special func. (2/3) Washing Start washing Washing period Washing duration Enable filling Filling duration Special func. (3/3) Select main screen display Language Show language choice at start-up?
	5. Supervisor	Supervisor config.

		ID number for BMS network) Com. speed Type of protocol Enable ON/OFF from supervisor
6. External alarms	External alarms	Water treatment Logic Compressor Logic Flow switch Logic
7. pLAN config.	pLAN config. (1/2)	pLAN Mode Press down arrow to set unit pLAN config. (2/2)
		M1: S2: S3: S4: S5: S6: Alarm delay:
3. Maintenance (password 77)	1. Reset conf.	Configuration Save config. Load config Default parameters Restore default parameters code: Type of humidifier System info
	2. System info	Boot (read only) Bios (read only) Code: Version: Date:
	3. Manual procedure	Manual controls (1/2) Manual procedure Air valve Water valve Drain valve Valve at end of line Production status Manual controls (1/2) Alarm relay Prop. output Prop. valve
	4 Hour counter	Hour counter Hours of production Reset hours
	5. Alarm log	Alarm log Alarm (read only) Log deleted Time (read only) Date (read only)

## 6. USER MENU

cabinet

distribution

maintenance

From the main screen press:

- PROG to access the main menu;
- ENTER to select and access the selected menu;
- UP/DOWN to move between the submenus;
- ENTER to enter the submenus
- ENTER to select the parameter and move between the parameters;
- UP/DOWN to modify the parameter;
- ENTER to confirm selected parameter and go to the next parameter;
- ESC to return to the previous menu.

User menu screens:

1. Alarm thresholds
2. Clock
3. Enable scheduler
4. Set scheduler
5. Weekly scheduler
6. Scheduled set point

### 6.1 Alarm thresholds

parameter	par. name	range	default	UOM
Main probe alarm thresholds	high alarm	0 to 100.0	100.0	%
	low alarm	0 to 100.0	0.0	%
Limit probe alarm thresholds	high alarm	0 to 100.0	100.0	%
Alarm delay		0 to 999	1	min

### 6.2 Clock

Used to set the timed activation of the humidifier

parameter	range
hour / min	0 to 23 / 0 to 59
day	1 to 31
month	1 to 12
year	00 to 99
format	dd/mm/yy - mm/dd/yy
weekday	Monday to Sunday

### 6.3 Enable scheduler

Enable control of the time bands and the set points

parameter	enabled
Scheduler On/Off	YES / NO
variable set point	YES / NO

When the time bands are set, the display shows the  symbol.

### 6.4 Set scheduler

 **Note:** this screen is visible if "scheduler ON/OFF" has been enabled (see the enable scheduler screen).

Setting of the intervals for the operation of the humidifier over one day (24h):

time band	ON	OFF

P1	P1-1	09:00	13:00
	P1-2	14:00	21:00
P2		14:00	21:00
P3		always ON	
P4		always OFF	

Parameters P1 to P4 can be used set how many times atomised water production is enabled/disabled over a 24h period:

P1 Two daily ON time bands

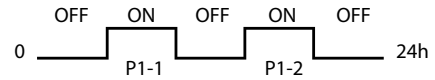

P2 Individual ON time band

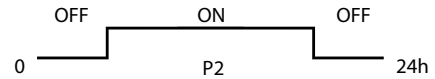

P3 Always ON

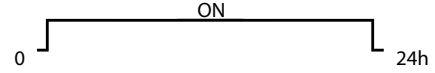

P4 Always OFF

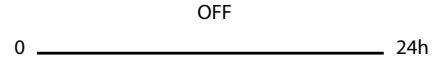

### 6.5 Weekly scheduler

 **Note:** this screen is visible if "scheduler ON/OFF" has been enabled (see the enable scheduler screen).

Setting of the weekly operation of the humidifier, using parameters P1 to P4 (configured in the previous screen)

parameter	type of time band
Monday	P1 to P4
Tuesday	P1 to P4
Wednesday	P1 to P4
Thursday	P1 to P4
Friday	P1 to P4
Saturday	P1 to P4
Sunday	P1 to P4

## 6.6 Scheduled set points

**Note:** this screen is visible if "variable set point" has been enabled (see the enable scheduler screen).

Setting of different levels of set points throughout the day (24 h):

parameter	ON	SETP.
	hours	%rH
Z1	00:00	0.0 to
Z2	00:00	0.0 to
Z3	00:00	0.0 to
Z4	00:00	0.0 to

Parameters Z1 to Z4 can be used to configure up to four different temperature set points at different times of a day (parameters Z1, Z2, Z3, Z4).

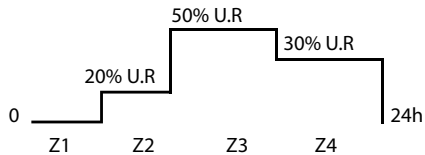

By setting the "daily" and "variable set point" time bands, atomised water production can be programmed according to the needs of the utility.

**Note:**

- during the "OFF" time band, the humidifier is NOT actually off, but rather atomised water production is temporarily disabled, even when setting manually;
- the "daily" time bands have priority over the "variable set point" bands. For example, setting P4 each Monday (humidifier off), parameters Z1, Z2, Z3, Z4 (different set point values) will not be observed, as the humidifier is not programmed to operate on that day.

## 7. INSTALLER MENU

From the main screen press:

- PRG to access the main menu;
- DOWN to move to the installer menu;
- ENTER to move to the password;
- UP/DOWN to enter the password "77"
- ENTER to access the selected menu;
- UP/DOWN to move between the submenus;
- ENTER to select the parameter and move between the parameters;
- UP/DOWN to modify the parameter;
- ENTER to confirm the selected parameter and go to the next parameter;
- ESC to return to the previous menu.

Installer menu screens:

1. Type of control
2. Probe configuration
3. Operating options
4. Special functions
5. Supervisor
6. External alarms
7. PLAN configuration

To navigate inside the screens:

- UP or DOWN to change the value (within the options/range),
- ENTER to confirm and move the cursor to the next value
- ESC to return to the installer menu.

### 7.1 Type of control

Settings: type of operation (ON/OFF or modulating), type of signal or probe, main probe, limit probe, unit of measure & stop slave offline.

parameter	options/range	description
Type of operation	ON/OFF	
	modulating	
Type of signal or probe	External contact	
	External proportional signal	
	External proportional signal & limit probe	
	Humidity probe	
	Humidity probe & limit probe	
	Temperature probe	
Main probe	select between: NTC; 0-1 V; 2-10 V; 0-10 V (default);	
Limit probe	0-20 mA; 4-20 mA; 0-135 ohm; 135-1k ohm	
Unit of measure	°C - bar (default)	
	°F - psi	
Stop slave offline	YES	if the pLAN network is offline the slave units stop
	NO	if the pLAN network is offline the slave units continue

### 7.2 Probe configuration

Setting of the minimum value, maximum value and offset for the probes used.

parameter	settings	range	default	UOM
Main probe config.	Min value	0 to 100	0	%rH °C/ °F
	Max value	0 to 100	100	%rH °C/ °F
	Offset	-10 to 10	0	%rH °C/ °F
Limit probe config.	Min value	0 to 100	0	%rH °C/ °F
	Max value	0 to 100	100	%rH °C/ °F
	Offset	-10 to 10	0	%rH °C/ °F

### 7.3 Operating options

#### Operating options (1/2)

parameter	description	range	default	UOM
Remote p. sensor	pressure sensor at end of line for balancing compressed air system	YES/NO	NO	
max. air pressure		0 to 4	2.1	bar
min. air pressure		0 to 4	1.2	bar
max air press. offset		0 to 9.9	0	
min air press. offset		0 to 9.9	0	

#### Operating options (2/2)

parameter	description	range	default	UOM
valve at end of line	to allow automatic emptying and periodical washing of the water line	YES/NO	YES	
logic alarm relay	alarm relay status setting	NO/NC	NO	
proportional signal set point:		3 to 60	10	%

### 7.4 Special functions

#### Special functions: automatic cleaning (1/3)

Nozzle self-clean cycles to reduce the frequency of maintenance.

parameter	range	default	UOM
Enabled	YES/NO	YES	
Period	0 to 999	30	min
Duration	60 to 999	160	s

#### Special functions: washing (2/3)

Automatic periodical washing of the water line to increase the hygiene of the installation.

parameter	range	default	UOM
washing	manual/automatic	man.	
start washing	NO/YES	NO	
washing period	1 to 99	6	h
washing duration	0 to 15	10	min
enable filling	NO/YES	NO	
filling duration	1 to 1000	5	s

#### Special functions (3/3)

parameter	range	default	UOM
select display on main screen	% signal; Hours; %rH; °C/°F	%rH	
Language	Italian, English, French, German, Spanish		
Show language choice at start-up?	YES/NO	YES	



## 7.5 Supervisor

parameter	range	def.	UOM
ID number for BMS network	0 to 200	1	
communication speed	1200; 2400; 4800; 9600; 19200	19200	bps
type of protocol	Carel; Modbus*; Lon; RS232; Winload	Carel	
enable ON/OFF from supervisor	YES/NO	NO	

## 7.6 External alarms

parameter	range	def.	UOM
water treatment	NO/YES	NO	
logic	NC/NO	NC	
compressor	NO/YES	NO	
logic	NC/NO	NC	
flow switch	NO/YES	NO	
logic	NC/NO	NC	

## 7.7 pLAN configuration

### pLAN configuration : mode (1/2)

parameter	range	def.	UOM
pLAN	master/master+slave	master	
Mode	multizone/single point	multizone	

### pLAN configuration: units present and names (2/2)

parameter	range	def.	UOM
M1(*)	YES/NO	YES	
S2/S3/S4/S5/S6(*)	YES/NO	NO	
Alarm delay	0 to 99	30	S

The MASTER and SLAVE units are named by default, however they can be renamed using the list of the characters shown below.

A	B	C	D	E	F	G	H	I	J	K	L
M	N	O	P	Q	R	S	T	U	V	W	X
Y	Z	0	1	2	3	4	5	6	7	8	9
+	-	*	:	;	,	(	)	/	#	%	

To modify the character in the space selected, use UP and DOWN, to confirm the character and move to the next space press ENTER.

## 8. MAINTENANCE MENU

cabinet

distribution

maintenance

**! Important:** the operations described in this menu must only be carried out by qualified personnel.

From the main screen press:

- PRG to access the main menu;
- DOWN to move to the maintenance menu;
- ENTER to move to the password;
- UP/DOWN to enter the password "77"
- ENTER to access the selected menu;
- UP or DOWN to move between the submenus;
- ENTER to select parameter and move between the parameters;
- UP/DOWN to modify the parameter;
- ENTER to confirm the selected parameter and go to the next parameter;
- ESC to return to the previous menu.

Maintenance menu screens:

1. Reset conf.
2. System info
3. Manual procedure
4. Hour counter
5. Alarm log

### 8.1 Reset configurations

#### Configuration

Functions:

- save the set configurations,
- recall the saved configuration

parameter	range	default
save configurations	YES/NO	NO
load configuration	YES/NO	NO

#### Default parameters

Functions:

- restore default parameters
- code

parameter	range	default
restore default parameters	YES/NO	NO
code	display only	

### 8.2 System information (read only)

information	display
Boot	read only
Bios	read only
Code	read only
Version	read only
Date	read only

### 8.3 Manual procedure

**! Important:** these operations must only be performed by qualified personnel, incorrect use may cause serious damage.

These procedures are used to manually test the main functions and operations of the humidifier.

#### Manual procedure (1/2)

parameter	range	default
manual procedure (*)	YES/NO	NO
air valve	ON/OFF	OFF
water valve	ON/OFF	OFF
drain valve	ON/OFF	OFF
valve at end of line	ON/OFF	OFF
production status	ON/OFF	OFF

#### Manual procedure (2/2)

parameter	range	default
alarm relay	YES/NO	NO
proportional output	ON/OFF	OFF
proportional valve	ON/OFF	OFF

(\*) To activate the individual manual procedures, first enable the manual procedure parameter.

### 8.4 Hour counter

parameter	range/display
hours production	display
reset hours	YES/NO

### 8.5 Alarm log

Recorded trace of the alarms (events) that have been activated. The humidifier memory can record up to 200 events (complete with description and date, press DOWN to scroll the list).

parameter	display
Alarm	event description
Log deleted	
Time	hh:mm
Date	dd/mm/yy

## 9. TABLE OF ALARMS

When an alarm is activated, the alarm button starts flashing intermittently.

In these conditions, pressing the alarm button once displays the type of alarm .

In the case of potentially dangerous alarms, the controller automatically stops production. For some alarm events, the alarm relay is also activated at the same time as the signal (see the table below).

alarms displayed	meaning	cause	solution	reset	alarm relay	action		notes
high humidity	humidity outside of set limits	value measured by the probe greater than the humidity alarm threshold	check the set parameter	manual	inactive	signal only	on	
low humidity	humidity outside of set limits	value measured by the probe less than the humidity alarm threshold	check the set parameter	manual	inactive	signal only	on	
humidity probe broken or disconnected	humidity probe broken or disconnected	main humidity probe disconnected or broken	check the connection & the operation of the probe	manual	active	stop production	on	
high humidity limit probe	limit humidity outside of set limits	value measured by the probe greater than the humidity alarm threshold	check the set parameter	manual	inactive	signal only	flash	can only be reset switching the unit off from "set", signalled only in sequence after other alarms but not when forced.
limit probe broken or disconnected	limit probe broken or disconnected	limit humidity probe disconnected or broken	check the connection & the operation of the probe	manual	active	stop production	on	
slave (2-3-4-5-6) unit offline	slave unit not connected to the pLAN	pLAN network disconnected	check connection of pLAN cable to terminals on controller	manual	active	signal only	on	
master unit offline	master unit not connected to the pLAN	pLAN network disconnected	check connection of pLAN cable to terminals on controller	manual	active	signal only	on	
low pressure alarm	insufficient air pressure	insufficient air pressure	check air line pressure	manual	active	stop production	on	for ON/OFF units
compressor	alarm from air compressor	compressor fault alarm	check air compressor	manual	active	signal only	on	
flow switch	alarm from AHU flow switch	no air in AHU alarm	check AHU	manual	active	signal only	on	
water treatment system	alarm from water treatment system	water treatment system fault alarm	check water treatment system	manual	active	signal only	on	
pressure sensor faulty or disconnected	pressure sensor faulty or disconnected	pressure sensor faulty or disconnected	check pressure sensor	manual	active	stop production	on	for proportional units with air pressure sensor
pressure off scale	air pressure outside of set limits	insufficient air pressure	check air supply pressure	manual	active	stop production	on	for proportional units with air pressure sensor
clock fault	clock error	backup battery completely discharged or generic clock fault	replace clock	manual	inactive	signal only	off	

# 10. ADVANCED FUNCTIONS

## 10.1 Wiring diagrams

Wiring diagram for ON/OFF version, Master codes:  
MC\*\*C\*M\*\*

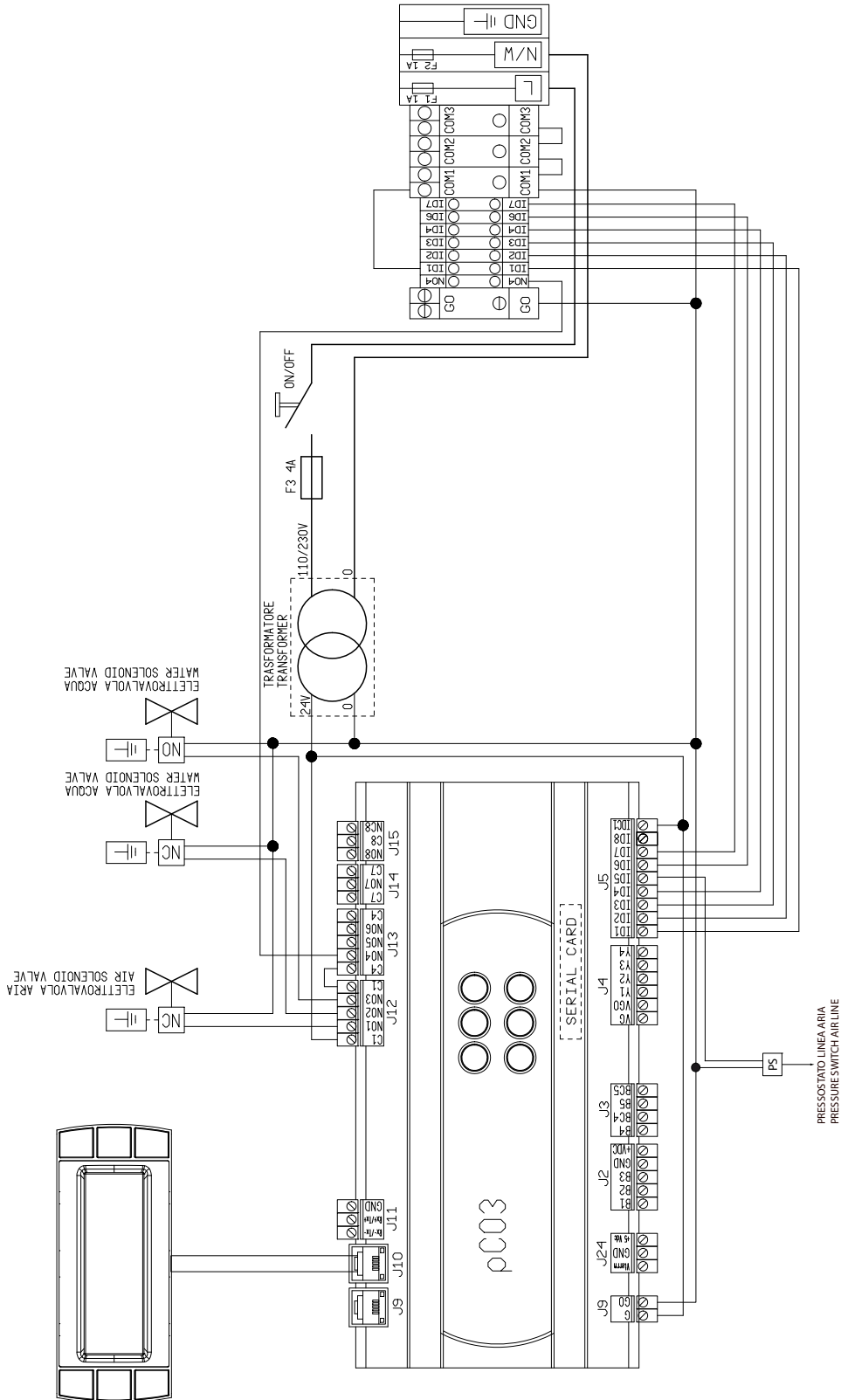

cabinet

distribution

maintenance

Wiring diagram for ON/OFF version, Slave codes:  
MC\*\*\*C\*S\*\*

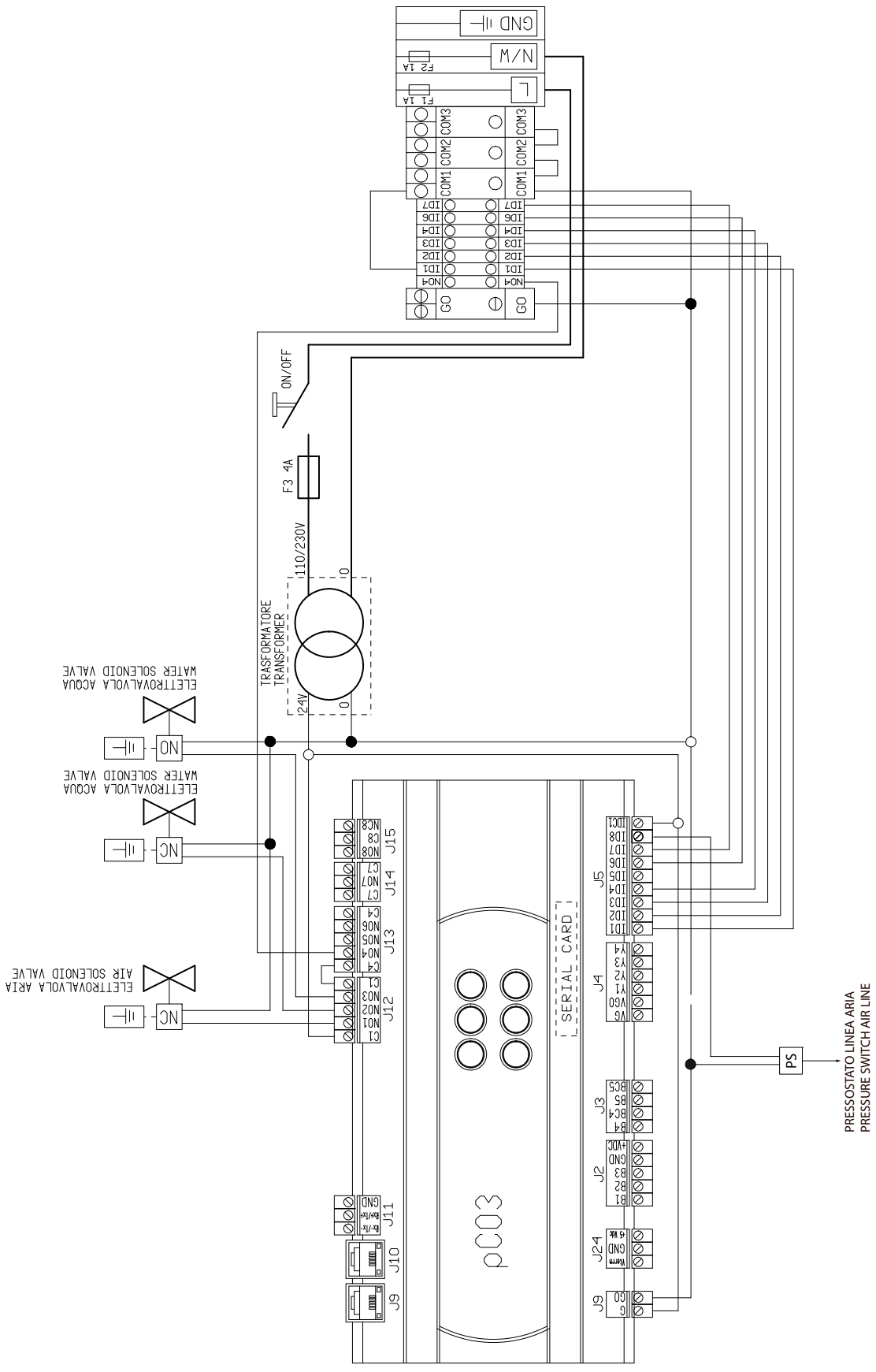

maintenance distribution cabinet

Wiring diagram for modulating version, Master codes: MC\*\*\*H\*M\*\*

cabinet

distribution

maintenance

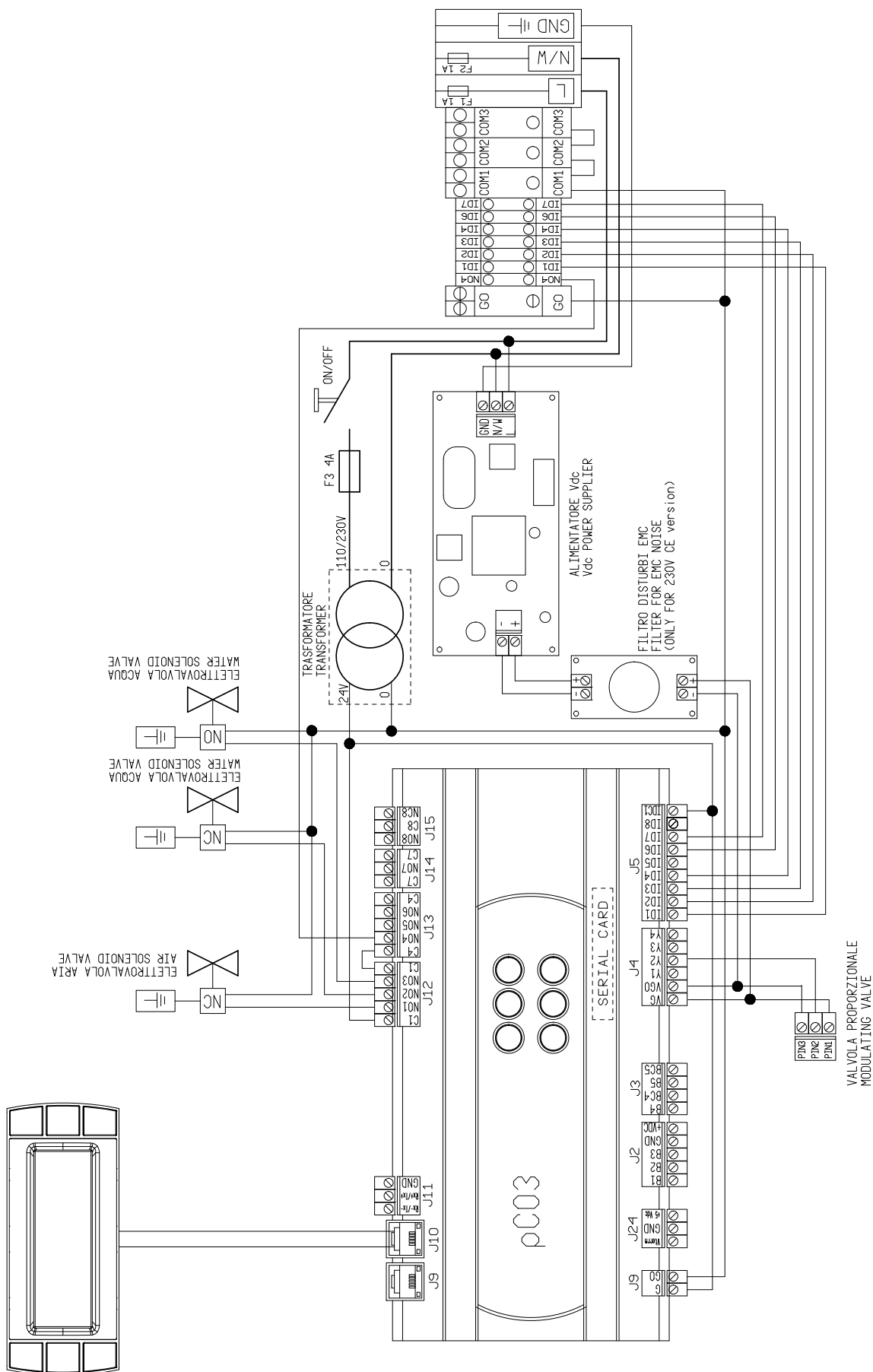

Wiring diagram for modulating version, Slave codes:  
MC\*\*\*H\*S\*\*

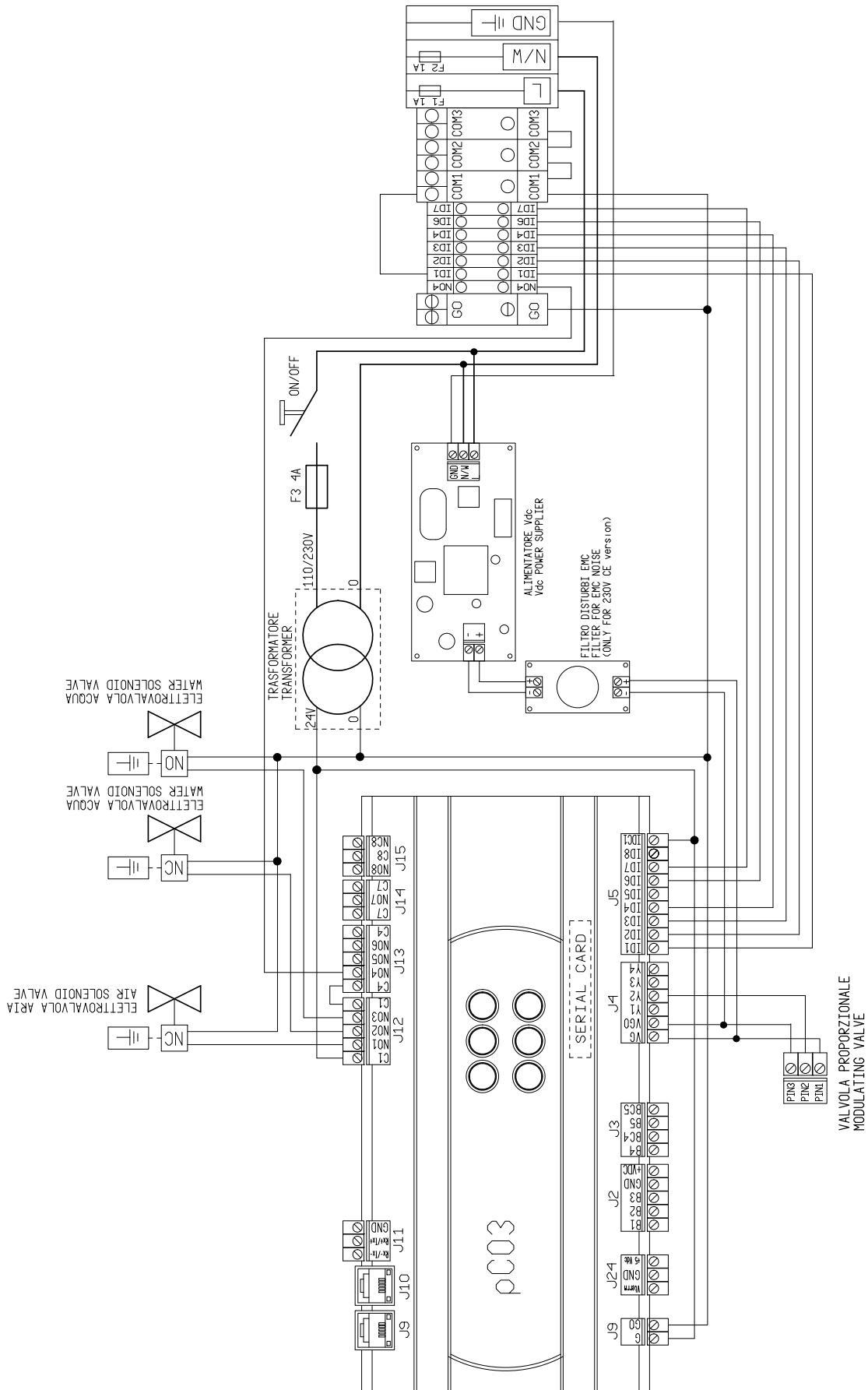

cabinet

distribution

maintenance

## 10.2 Operating principle

The humidifier controller - based on the input signal from a probe, an ON/OFF contact or external controller - activates the cabinet to start the production of atomised water (at maximum capacity), and stops the production when the set point is reached.

As well as the room probe, the limit probe for humidity control is fitted in a significant point of the installation to avoid excessive condensation. Normally the humidity control probe is located in the ducts of the air handling unit.

### ON/OFF operation

The activation logic is:

- Request **ON** (contact closed) → Humidifier in production
- No request **OFF** (contact open) → Humidifier in stand by (not in production)

### Status of the outputs:

Humidifier in production:

- Water line active (NO drain solenoid valves active, NC fill solenoid valve active)
- Air line active (NC air line activation solenoid valve active)

Humidifier off (not in production):

- Water line inactive (NO drain solenoid valves deactivated, NC fill solenoid valve deactivated)
- Air line inactive (NC air line activation solenoid valve deactivated)

### Operation in modulating versions

The humidifier controller - based on the input signal from a temperature or humidity probe, or external controller - activates and modulates the quantity of compressed air so as to achieve a humidification capacity proportional to the request from the external controller, or to the difference between the desired value (set point) and the value measured by the probe.

In this case too, the limit probe is also used to measure the humidity in a significant point of the installation and avoid excessive condensation.

In **modulating** operation, the system MANAGES a **humidity set point**, with an optional limit signal from the second probe, a **temperature set point** or a **request signal (proportional)**.

Standard control of humidity production is performed using a proportional valve (AO2) controlled by a 0 to 10 V signal. The system behaves as follows:

### Status of the outputs:

Humidifier in production:

- Water line active (NO drain solenoid valves active, NC fill solenoid valve active)
- Air line active (NC air line activation solenoid valve active, Proportional valve controlled proportionally to required pressure)

Humidification not request:

- Water line inactive (NO drain solenoid valves deactivated, NC fill solenoid valve deactivated)
- Air line inactive (NC air line activation solenoid valve deactivated, proportional valve closed)

The use of the request signal and the extent of control of the proportional air valve depends on the type of control selected.

ON/OFF and modulating control share the ratio between the values, that is, the maximum signal applicable to the proportional solenoid valve corresponds to the rated production (Pnom).

## 10.3 Control principles

### ON/OFF control from contact

The action is all or nothing, activated by an external contact that consequently determines the control set point and differential.

The external contact may be a humidistat, whose status determines the operation of the humidifier:

- contact closed: the humidifier produces atomised water if the remote ON/OFF contact is also closed;
- contact open: production ends.

### ON/OFF control with humidity probe

The action is all or nothing, activated based on the reading of the probe, production starts and reaches the maximum when the relative humidity is lower than the set point by the set differential.

To set the set point and differential for the main control probe: SET menu.

To check that the value measured by the probe is within certain preset values, two alarm thresholds can be set:

- high humidity alarm threshold;
- low humidity alarm threshold.

When these thresholds are exceeded, an alarm is activated, after a set delay.

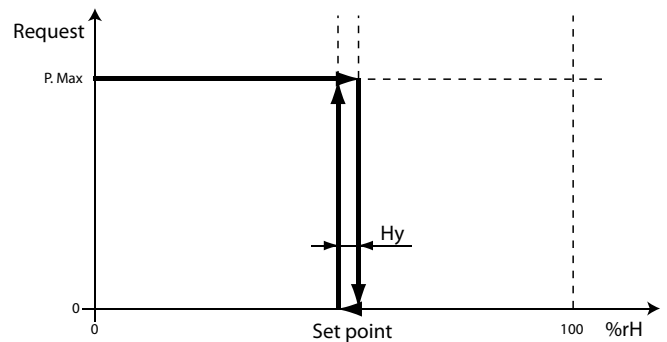

### ON/OFF control with temperature probe

The action is all or nothing, activated based on the reading of the probe, production starts and reaches the maximum when the temperature is lower than the set point by the differential.

To set the set point and differential for the main control probe: SET menu.

To check that the value measured by the probe is within certain preset values, two alarm thresholds can be set:

- high temperature alarm threshold;
- low temperature alarm threshold.

When these thresholds are exceeded, an alarm is activated, after a set delay.

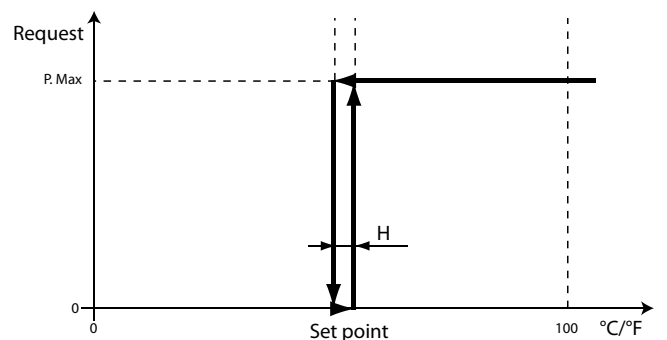



**Proportional control**

The production of atomised water is proportional to the value of a signal "Y" from an external device. The type of signal can be selected between the following: 0 to 1 Vdc, 0 to 10 Vdc, 2 to 10 Vdc, 0 to 20 mA, 4 to 20 mA, 0 to 135 Ohm, 135 to 1000 Ohm (installer menu > type of control > type of signal)

The entire range is indicated as BP (proportional band).

The maximum production of the humidifier, corresponding to the value maximum of the external signal, can be set from 50% to 100%. The minimum production corresponds to 10% (default, range 3-60%) of the external signal:

- if set point < 10%, hysteresis of 2%;
- if set point > 10%, hysteresis of 5%.

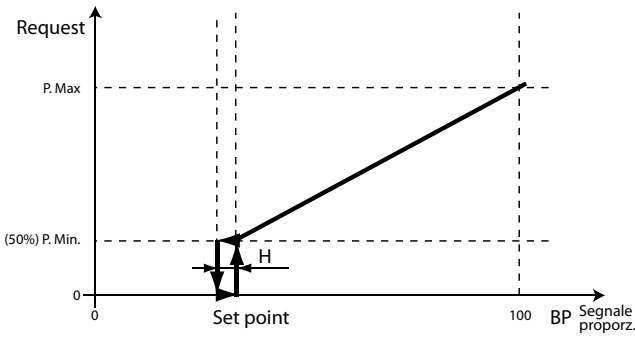

**Proportional control with limit probe**

See "proportional control", with the addition of a limit probe, generally installed in the air duct downstream of the humidifier. This type of control is used to reduce production if the relative humidity, downstream of the humidifier, is within the proportional band set for the limit probe. Production is stopped if the relative humidity, downstream of the humidifier, reaches the limit set point %rH2.

To set the set point and differential for the limit probe: "quick set menu".

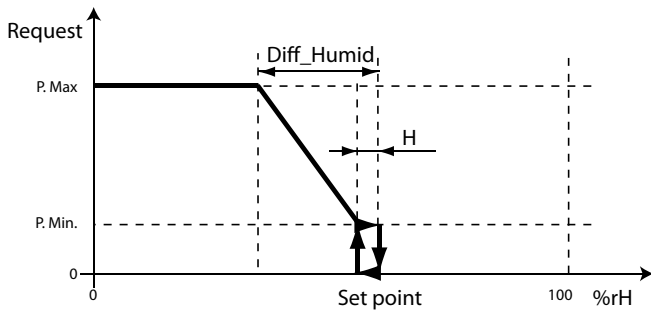

**Independent control with relative humidity probe**

The production is related to the reading of the probe and increases as the relative humidity value read decreases. The production reaches the maximum when the relative humidity is lower than the set point (St) by a value at least equal to the differential. The maximum production can be programmed between 50% and 100% of the rated value of the humidifier. To set the set point and differential for the main control probe: "quick set menu".

The minimum production has an activation hysteresis, "hy", equal to 0.2% rH

To check that the relative humidity measured by the probe is within certain preset values, two alarm thresholds can be set in independent control:

- high humidity alarm threshold;
- low humidity alarm threshold.

When these thresholds are exceeded, an alarm is activated, after a set delay.

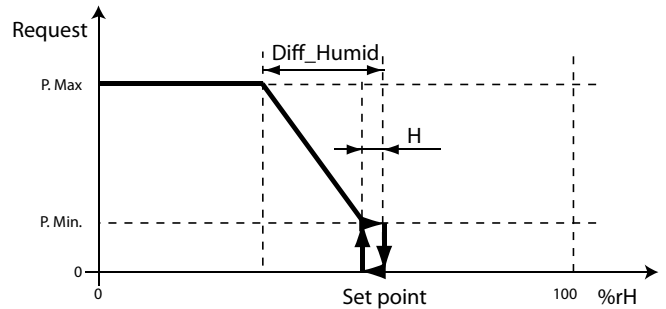

**Independent control with relative humidity probe and limit probe**

See control with main probe, combined with a limit probe, installed in the air duct downstream of the humidifier.

This type of control is used to reduce production if the relative humidity, downstream of the humidifier, is within the differential band of the limit probe. Production is stopped if the relative humidity, downstream of the humidifier, reaches the limit set point %rH2.

**Temperature control for cooling applications**

When using the humidifier for adiabatic cooling, instead of the humidity probe in the room, a temperature probe is used. The production of atomised water is related to the temperature **T read** by the temperature probe (AO1), and increases as the distance from the set point **St** increases. Maximum production (**Pmax**), which occurs when the room temperature is greater than the set point by a value equal to the differential (**T differential**), can be set between 50% and 100% of rated production (**Pnom**). The activation hysteresis (default 0.2 °C) is indicated in Figure 4.2 as **hy**.

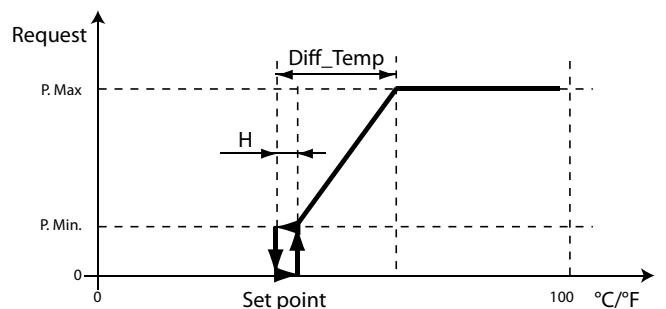

## Temperature control with humidity limit probe

The production of atomised water depends on the reading of the temperature probe, with a second humidity probe (AO3) that limits production, so as to limit the humidity level in the cooled air. The limit probe has a set point (L set point), a differential (L diff.) and an activation hysteresis (0.2% rH). Production is the result of the difference between the two readings.

### 10.4 Pressure control

Pressure control in the air line is fundamental as this is used to control production. Depending on the model, pressure may be controlled using:

- Manual regulating valve (ON/OFF operation)
- Manual regulating valve & pressure transducer in line (ON/OFF operation)
- Proportional valve (modulating operation)
- Proportional valve & pressure transducer (modulating operation)

### MC models with ON/OFF controller

The pressure is controlled using the pressure gauges installed in the air line, which signal if the value is above or below the calibration of the manual pressure regulator. The correct operating pressure will be thus be controlled by the operator, when commissioning the installation, using the pressure gauges in the line and the manual regulating valve.

### MC models with ON/OFF controller and pressure transducer (recommended)

The transducer is available as an optional component, upon request, including 10 m, 50 m or 100 m cable.

The system works in "all or nothing" mode and displays the signal of the pressure transducer, providing indications to the operator on the calibration of the air line using the manual regulating valve.

### MC models with control by proportional valve

The system provides a signal to the proportional valve to modulate the pressure in the air line, from a minimum to a maximum, depending on the request from the humidity probe or the external controller.

The minimum and maximum pressure values are set using the related parameters.

If there is significant pressure drop along the line - measured by the operator using a pressure gauge installed at the end of the line - a parameter (see installer menu > operating options (1/2)) can be used to set a pressure offset as compensation. The pressure offset is summed to the signal sent to the proportional valve to compensate for the pressure drop.

### MC models with control by proportional valve & pressure transducer (recommended)

The transducer is available as an optional component supplied upon request by Carel SpA, the kit includes:

- transducer
- connector
- 10 m, 50 m or 100 m cable.

In this case, as well as control with the proportional valve, the pressure transducer installed at the end of the line measures the air pressure and tells the electronic controller (which manages the proportional valve) to automatically compensate for pressure drop along the line.

In this way, the system can supply the required pressure and automatically manage any pressure drop in the line.

## 10.5 Drain/fill



**Important:** this function requires the installation of a CAREL NO drain solenoid valve at the end of the water line, available as an option.

For hygiene reasons, when the system is not operating the water line is emptied to avoid bacterial formation inside. This is done using the normally-open drain solenoid valves located inside the cabinet and at the end of the line. The fill operation is performed as follows, starting from empty:

- the NC water fill solenoid valve in the cabinet is activated (opened);
  - the NO drain solenoid valve in the cabinet is activated (closed);
  - the NO solenoid valve at the end of the line is deactivated (opened).
- The duration of the fill cycle can be set by parameter and depends on the length of the line. During the filling phase, the air line is deactivated. At the end of the cycle, the NO drain solenoid valve at the end of the line will be closed and the air line will be activated so as to resume production. The function can be activated by parameter, and when deactivated, the status is as illustrated in chapters 3 and 4.

## 10.6 Periodical washing of the water line

Function required for hygiene/health reasons when the humidifier is not operating. To activate this function: installer menu > special functions > special functions (2/3), can be performed automatically by time or manually.

The washing procedure is similar to the fill cycle described above, starting from empty

- the NC water fill solenoid valve in the cabinet is activated (opened);
- the NO drain solenoid valve in the cabinet is activated (closed);
- the NO solenoid valve at the end of the line is deactivated (opened).

The duration of the wash cycle is longer than the fill cycle and, in this case too, depends on the length of the line.

The duration and the frequency of the wash cycle can be set by parameter.

During the washing phase, the air line is deactivated

## 10.7 Automatic cleaning of the atomising heads

To activate this function: installer menu > special functions > special functions (1/3); can be performed:

- **During** a production cycle
- **At the end of** a production cycle

Cleaning involves **deactivating the water fill, keeping the air line active** (at 100% in the case of modulating operation, or simply activated for ON/OFF operation), **activating (opening) the NO water drain solenoid valves at the end of the line and in the cabinet.**

The duration of the operation can be set by user parameter, in addition the frequency during the production cycle can also be set, as well as whether or not to perform the operation at the end of the production cycle.

## 10.8 Pressure overboost

To ensure the correct opening and modulation of the atomising heads, at the start of each production cycle, these are supplied with compressed air only, at a pressure of:

- 2.1 bars for ON/OFF versions.
- 3 bars for proportional versions.

During this phase, the water line is not activated.

This function is not managed by parameter.



# 11. GENERAL CHARACTERISTICS OF THE DISTRIBUTION SYSTEM

## 11.1 Atomising head

The atomising heads are available in AISI 316 stainless steel with 5 different flow-rates, yet all with the same dimensions and weights. Each atomising head has a marking on the nozzle indicating the model and thus the flow-rate.

Marking	Code	Capacity
A	MCAA200000	2.7 l/h
B	MCAB200000	4.0 l/h
C	MCAC200000	5.4 l/h
D	MCAD200000	6.8 l/h
E	MCAE200000	10 l/h

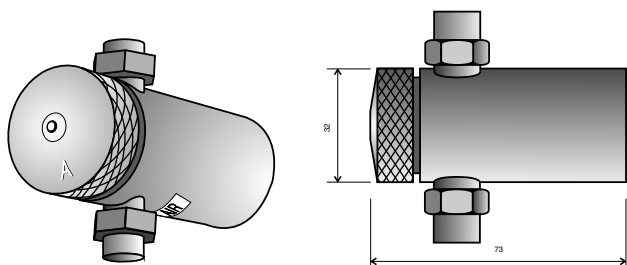

## 11.2 Assembly kit

This is a series of components designed to make the assembly of the atomising heads on the air-water lines simpler and faster; it can be used for both normal water and demineralised water (aggressive).

Only one model is available:

- MCK1AW0000 for assembly of the heads on the lines in the room or in the duct.

### Kit MCK1AW0000

1. 1/4" FF elbow connector
2. 1/4" H43 MF column
3. 1/4" nipple
4. 1/4" MF 2-way valve
5. 1/4" PVSF 2-way valve
6. 1/4" 180° M connector
7. BTFN nylon tube dia. 6/8 mm
8. 1/4" FF elbow connector dia. 6/8 mm
9. 1/4" FF hose coupling

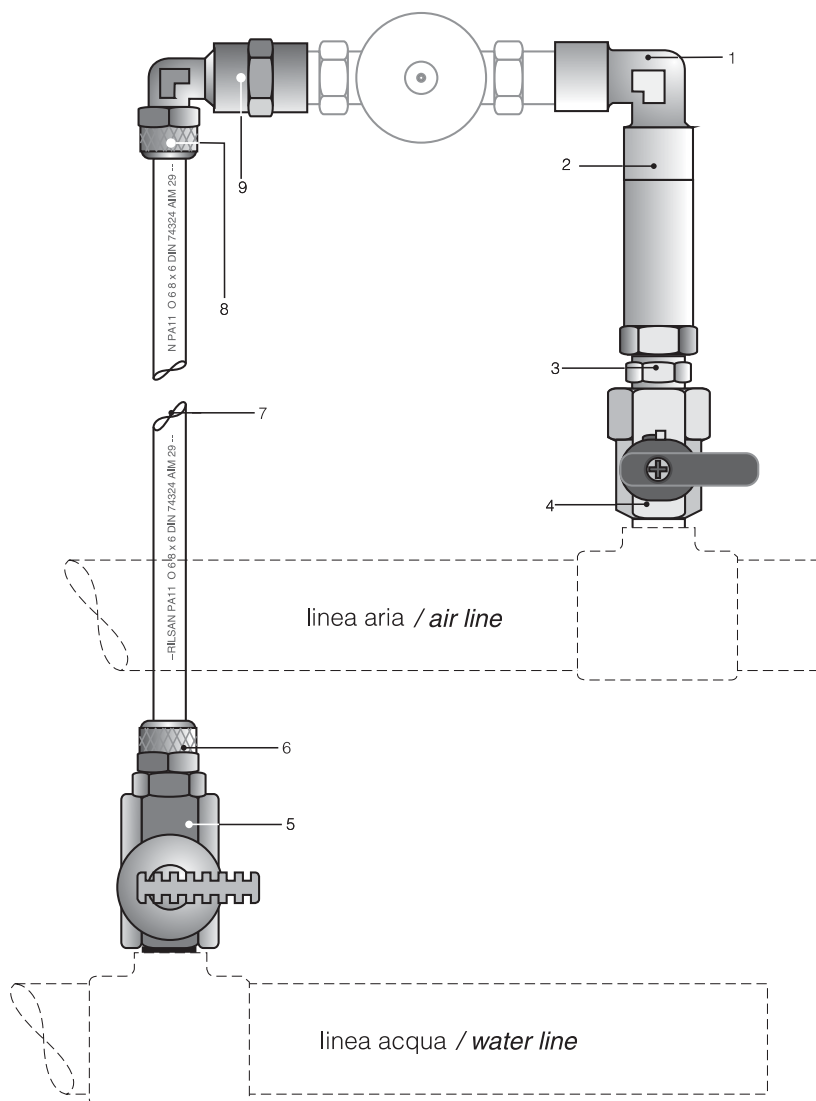

cabinet

distribution

maintenance

## 12. DESIGNING A SYSTEM

### 12.1 Sizing an MC system

When sizing an MC system, several factors must be considered: air flows, flow speed, presence of cooling coils, dimensions of the room where the humidifier will be installed. For correct sizing, given the relative complexity of the factors involved, the applications should be designed using the documents provided by CAREL.

To calculate the humidification requirements of a certain space, a series of factors need to be considered:

- volume of the local (m3);
- current conditions of the room: temperature (°C) and relative humidity (% rH);
- desired conditions in the room: temperature (°C) and relative humidity (% rH);
- characteristics of the materials inside (quantity, hygroscopic factor, number of people);
- time required to reach steady operation;
- inlet of outside air (infiltration, occasional opening of doors or windows);
- air change (m3/h);
- outside design conditions: temperature (°C) and humidity (% rH);
- condensation on the cooling coil.

 **Note:** If there is no fresh air inlet, once the required relative humidity value is reached the humidification system will not need to work much to maintain the humidity level. Consequently, to save running costs when high capacities are required, check the time required to reach steady operating conditions.

### 12.2 Sizing the compressor

Careful attention needs to be paid to sizing the compressor. The air consumption is determined by the capacity of the installation and not by the maximum flow-rate of the cabinet. Consequently, the number of atomising heads in the installation and their flow-rate need to be considered. The air flow-rate of each head may have the following values:

	MCAA2	MCAB2	MCAC2	MCAD2	MCAE2
Nm <sup>3</sup> /h	3.43	5.08	6.86	8.64	12.7
CFM	2	3	4	5	7.5

The air consumption for all heads is equal to:

- 0.41 m3/h per litre of water at an operating pressure of 2.1 bars;
- 1.27 Nm3/h per litre of water at atmospheric pressure;
- 0.75 CFM per litre of water at atmospheric pressure.

system flow-rate l/h	type of heads					line length							
	A	B	C	D	E	5 m		10 m		25 m		50 m	
	no. heads installed per type					air	water	air	water	air	water	air	water
						ID mm	ID mm	ID mm	ID mm	ID mm	ID mm	ID mm	ID mm
30	11	8	6	4	3	15	12	20	14	20	15	25	18
60	22	15	11	9	6	20	12	25	14	30	15	30	18
120	44	30	22	18	12	30	12	30	14	35	15	40	18
230	85	58	43	34	23	35	12	40	14	45	15	55	18

The table below describes the specific consumption for each individual head in Normal m3/h and CFM (Cubic Feet per Minute), referred to atmospheric pressure:

Calculation example:

Installation of 18 MCAC2 heads supplied by a 230 l/h cabinet.

$$V = C_{\text{head}} \times n = 6.86 \times 18 = 123.5 \text{ Nm}^3/\text{h} = 2058 \text{ l/m}$$

(referred to the rated data of the compressor)

where:

V = volume of air taken in by the compressor or introduced into the room by the installation (Nm3/h)

C<sub>head</sub> = air consumption of each head (Nm3/h)

n = number of heads

 **Note:** In order to guarantee the right air flow-rate in all conditions, the size should be overrated by 10%.

### 12.3 Sizing air/water lines between cabinet & distribution system

The pipes or hoses carrying air and water to the atomising heads must be made from copper or plastic. DO NOT USE GALVANISED STEEL PIPES as these may release impurities that block or damage the heads. When supplying the cabinet with demineralised water, only use plastic or stainless steel pipes. If the cabinet is supplied with demineralised water (aggressive), Teflon or liquid Teflon must be used as the sealant.

In alternative to the above, polypropylene hoses can be used, which allow faster and simpler connections by welding.

To determine the diameters of the air/water outlet lines, refer to the tables below. Make sure that the inside diameter of the pipes/hoses selected is as described in the table under the item "ID".

Always make sure that the rated pressure of the pipes/hoses is suitable for the operating pressure of the installation, in any case PN8 or higher diameter pipes/hoses are recommended.

system flow-rate lb/h	type of heads					line length							
	A	B	C	D	E	16 feet		32 feet		80 feet		160 feet	
	no. heads installed per type					air	water	air	water	air	water	air	water
						ID mm	ID mm	ID mm	ID mm	ID mm	ID mm	ID mm	ID mm
65	11	8	6	4	3	5/8	1/2	3/4	5/8	3/4	5/8	1	3/4
130	22	15	11	9	6	3/4	1/2	1	5/8	1 1/4	5/8	1 1/4	3/4
260	44	30	22	18	12	1 1/4	1/2	1 1/4	5/8	1 3/8	5/8	1 1/2	3/4
500	85	58	43	34	23	1 3/8	1/2	1 1/2	5/8	1 3/4	5/8	2 1/4	3/4

**Note:** If the air line is more than 50 metres long, size the line so that the pressure drop does not exceed 0.2 bar.

Try to limit the number of connections in the air and water lines to the minimum possible.

The use of elbow or "T" connectors and reducers/adapters will increase the pressure drop in the lines. The diameters shown in the tables have been selected considering the use of a pair of connectors in each line, if the number of connectors doubles choose the next largest diameter.

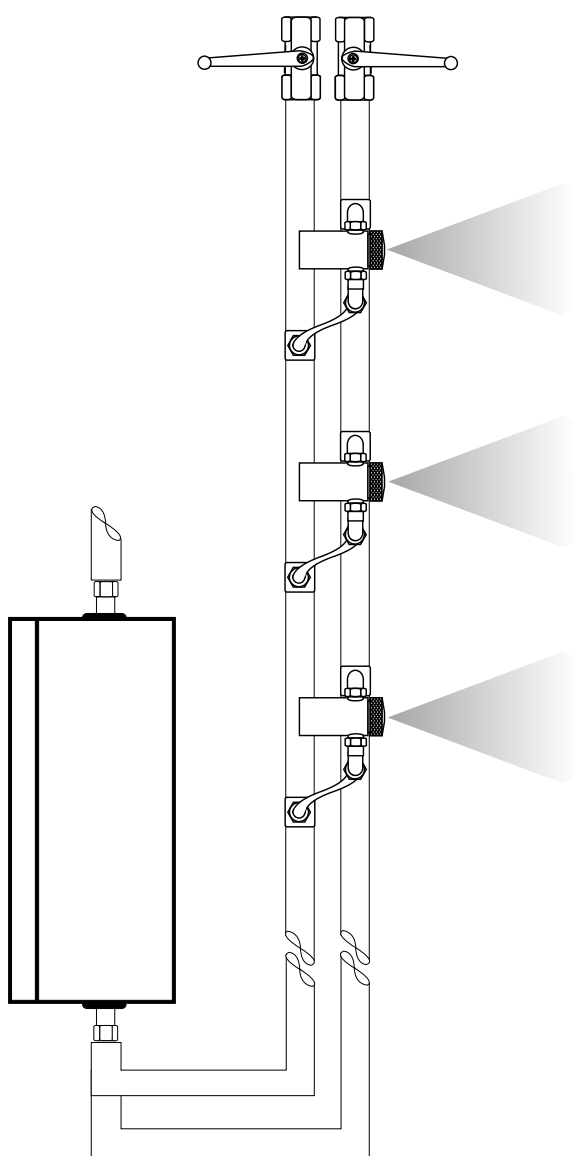

## 13. INSTRUCTIONS FOR INSTALLATION IN ROOMS

### 13.1 Tips for correct installation

**Note:** see Chapter 2 for the connection of the atomising heads.

The air line also acts as the support for all the heads. The water line must always be lower than the atomising heads to ensure emptying and drying when the installation is off.

Size the water and air lines as shown in the table in paragraph 4.3

### 13.2 Assembling the atomising head

For each atomising head, a kit for assembly in the room is available that makes installation simpler and faster. The assembly kit can be used both for normal water and for aggressive water. The drawing (paragraph 3.2) illustrates how to fit the kit.

- All the atomising heads must be installed at the same height to avoid variations in pressure that would make the sprays of atomised water less uniform.
- The assembly kit allows the head to be turned vertically so as to aim the spray as desired.
- A readily accessible ball valve should be installed at the end of each line for cleaning (bleeding) the lines when first starting and at the start of each season.
- The water lines must not have “pockets” along the path so that the installation can be drained completely by gravity when stopped.
- Make sure not to reverse the water/air inlets on the atomising heads; the air inlet is always marked by a label showing “AIR”.

### 13.3 Positioning the humidity probes

The cabinet control system can be connected to:

- signal from an external controller.
- ambient humidity probe.
- signal from external controller plus limit probe.
- two humidity probes: ambient plus limit
- one temperature probe and one limit probe.

If installing humidity and temperature probes:

- **The ambient humidity control probe** must be located inside the return air duct. This sensor can also be positioned in the room being humidified. Make sure, however, that the place where it is installed is away from flows of air that are hotter or colder than the environment, or is not in contact with perimeter walls.
- **The temperature probe** must follow the same rules as described above for the humidity probe.
- **The high humidity limit probe** should be located downstream of the atomisation manifold in a position where it cannot be wet by the jet of atomised water (e.g. after the cooling coil, or after a droplet separator, or near the fan).

### 13.4 Important rules to be followed

There are a number of important rules to be observed when installing an MC humidification system:

1. The jet of atomised water must not come into contact with any object along its path so as to avoid condensation and thus dripping. Any obstacles in the trajectory of the jet of water can be avoided by suitably aiming the atomising heads. Table shows the length and the maximum diameter of the jet in relation to the humidity in the room. The heads must also be installed so as to avoid two separate sprays from overlapping. It is recommended to install them, inside the area being humidified, as high as possible, without however wetting the ceiling.

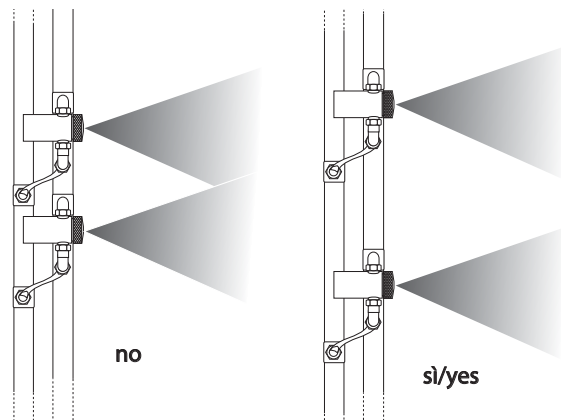
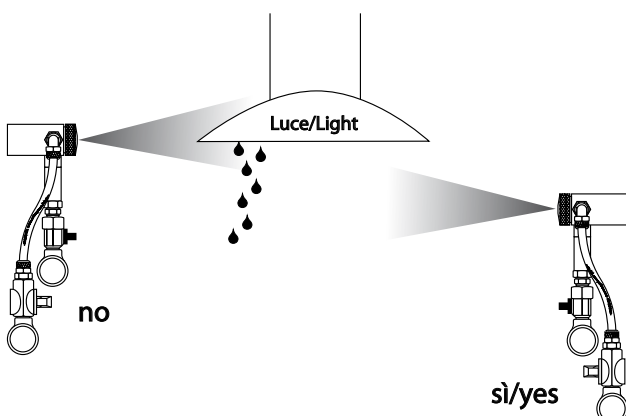

head flow-rate	minimum installation height	max spray diameter	visible spray distance <50% rH	visible spray distance >50% rH
2.7 l/h	4 m	0.75 m	3.00 m	4.55 m
4.0 l/h	4 m	0.75 m	3.35 m	4.90 m
5.4 l/h	4.6 m	0.90 m	3.65 m	5.20 m
6.8 l/h	6.1 m	1.20 m	4.00 m	6.10 m
10.0 l/h	9.4 m	1.50 m	4.60 m	7.00 m

2. The air/water lines must not have variations of height.
3. If the filling and washing functions are featured, install the NO drain solenoid valve supplied as an option at the end of the line. The drain hose connected downstream of the solenoid valve must have a diameter that is greater than or equal to diameter of the line upstream. If this is not installed, fit an easily accessible ball valve for cleaning (bleeding) the line when commissioning and restarting each season.
4. At the end of the air line, an easily accessible ball valve should be fitted for cleaning (bleeding) the line when commissioning and restarting each season.
5. To control the pressure in the air line, use one of the following devices, installed at the end of the line:
  - Pressure gauge (supplied as an option)
  - Pressure transducer (supplied as an option)
  - With the devices listed above, depending on the type of cabinet used, refer to the following:
 

**for ON/OFF cabinets:**

    - With a pressure gauge installed at the end of the line, the pressure drop in the line can be displayed and, if necessary, the pressure increased to 2.1 bars using the manual pressure regulator located inside the cabinet.
    - With the pressure transducer, the pressure at the end of the line can be shown on the controller display and, if necessary, increased using the manual pressure regulator.

**for cabinets with modulating control:**

    - With a pressure gauge installed at the end of the line, the pressure at the end of the line can be read and, if necessary, increased using the corresponding parameter on the electronic controller.
    - With the pressure transducer, the cabinet automatically controls the pressure in the installation to the optimum value so as to compensate for any pressure drop in the line.
6. The cabinet drain line must be connected directly to a drain cycle at a height of at least 50 mm below the level of the heads.
7. The position of the cabinet must be selected so as to guarantee the shortest path to the lines. If the lines are very long (>50 m), the cabinet should be positioned in the centre of the line, so as to balance the pressure.
8. The atomising heads must be distributed so as to uniformly cover the entire area involved. The control cabinet must always be located in a central position in reference to the layout of the heads.
9. The humidity sensor must be positioned where possible in a central area of the space being humidified, in a point in which there are no flows of humidified air and atomised water from the atomising heads. In addition, avoid fitting the humidity sensor on a perimeter wall of the building, as the temperature of the wall may be affected by the outside temperature and thus influence the reading.
10. Shielded cables should be used to connect the control cabinet to the following devices:
  - humidity, limit and temperature probes, air line pressure sensor (optional)
  - water line drain solenoid valve (optional).

Avoid running these cables near other power cables (electric motors, contactors, high voltage wires, etc...)



# 14. INSTRUCTIONS FOR INSTALLATION IN DUCTS

For duct applications, the solution with two probes is recommended:

- humidity probe or signal from external controller
  - limit probe
- this solution can be used indifferently for both types of cabinet:
- ON/OFF
  - Modulating

The modulating cabinet is recommended for this type of application. By modulating the capacity of the atomisation system, the maximum possible production can be delivered without ever reaching saturation conditions inside of the duct. The atomisation manifold (Fig. 11) is made up of an air line and a water line located below. At the end of the lines, two ball valves should be installed for bleeding the lines.

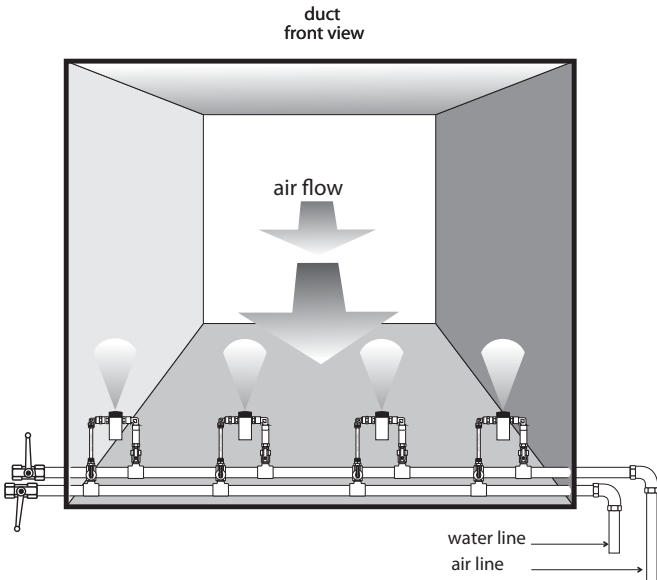

cabinet	air line	water line
230 l/h	22 mm (1/2" G)	22 mm (1/2" G)
60 l/h	14 mm (1/2" G)	14 mm (1/2" G)

## 14.1 Positioning the atomisation manifold

Figure 12 shows the possible positions for the atomised water manifold. The control cabinet must where possible be installed near the manifold with the atomising heads.

Critical measurements for the assembly of the manifold in the duct:

1. **Distance of the heads from the surfaces of the duct::**

The maximum distance H reached by the jets of atomised water is shown in the under table. The distance H is very important for preventing the jet of atomised water from wetting the duct; this is the most typical installation the manifold (Fig. 14.a).

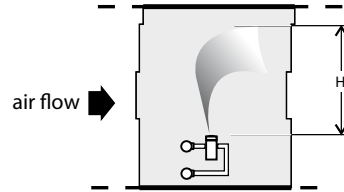

Fig. 14.a

Maximum distance H in mm reached by the jet

air speed in m/s	2.7 l/h	4.0 l/h	5.4 l/h	6.8 l/h	10 l/h
	distance H in mm				
2.0	660	737	914	1219	1792
3.0	610	686	838	1092	1605
4.0	559	610	737	965	1419
5.0	508	559	660	838	1232
6.0	457	508	559	711	1045
7.5	406	432	483	584	859
10.0	356	381	406	432	635

If the height available is not sufficient, the manifold can be installed as shown in Fig. 14.b. This type of installation is used to humidify in smaller ducts. Any losses due to condensation and removed by the droplet separator will however be greater.

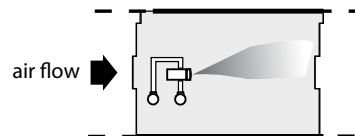

Fig. 14.b

Never fit the heads against the flow

If, based on the top table, the height of the duct is not sufficient, one solution may be to fit the manifold outside the duct, with the ends of the nozzles spraying inside, as can be seen in Fig. 14.c. This saves around 20 cm.

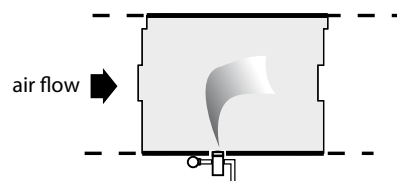

Fig. 14.c

cabinet

distribution

maintenance

## 14.2 Important rules to be followed

1. The minimum distance between two adjacent heads must never be less than 100 mm. This is also the minimum distance between the heads at the end and the side of the duct.
2. To determine the distance between heads, divide the width of the duct by the number of heads plus one. If the distance is less than 100mm, more manifolds should be used, and if possible, larger capacity heads.
3. If the height of the duct (D) is greater than::

$$D = 2 \times H + 100 \text{ mm}$$

(where H is the maximum distance in mm reached by the jet sprayed by the heads to the top of the duct, as in Table 4), then the manifold can be placed in the centre of the duct with the heads facing alternately up and down.

4. The minimum height of the duct (M) to be able to install the distribution manifold with a 90° jet is equal to:

$$M = H + 180 \text{ mm}$$

If this space is not available, then the heads must be installed outside of the duct with the jet spraying inside (Fig. 14.c) or lower capacity heads used.

5. The jet of atomised water must never come into contact with obstacles (wall reinforcement bars) before total evaporation (free path of evaporation - PL).
6. Never fit the heads in the opposite direction to the air flow.
7. If the filling and washing functions are featured, install the NO drain solenoid valve supplied as an option at the end of the line. The drain hose connected downstream of the solenoid valve must have a diameter that is greater than or equal to diameter of the line upstream. If this is not installed, fit an easily accessible ball valve for cleaning (bleeding) the line when commissioning and restarting each season.
8. At the end of the air line, an easily accessible ball valve should be fitted for cleaning (bleeding) the line when commissioning and restarting each season.
9. To control the pressure in the air line, use one of the following devices, installed at the end of the line:  
Pressure gauge (supplied as an option)  
Pressure transducer (supplied as an option)  
With the devices listed above, depending on the type of cabinet used, refer to the following:

### for ON/OFF cabinets:

- With a pressure gauge installed at the end of the line, the pressure drop in the line can be displayed and, if necessary, the pressure increased to 2.1 bars using the manual pressure regulator located inside the cabinet.
- With the pressure transducer, the pressure at the end of the line can be shown on the controller display and, if necessary, increased using the manual pressure regulator.

### for cabinets with modulating control:

- With a pressure gauge installed at the end of the line, the pressure at the end of the line can be read and, if necessary, increased using the corresponding parameter on the electronic controller.
- With the pressure transducer, the cabinet automatically controls the pressure in the installation to the optimum value so as to compensate for any pressure drop in the line.

## 14.3 Positioning the humidity probes

If installing humidity and temperature probes:

- The ambient humidity control probe must be located inside the return air duct. This sensor can also be positioned in the room being humidified. Make sure, however, that the place where it is installed is away from flows of air that are hotter or colder than the environment, or is not in contact with perimeter walls.
- The temperature probe must follow the same rules as described above for the humidity probe.
- The high humidity limit probe should be located downstream of the atomisation manifold in a position where it cannot be wet by the jet of atomised water (e.g. after the cooling coil, or after a droplet separator, or near the fan).

## 14.4 Manifolds for installation in ducts

Special manifold kits are available for installations in ducts, sized according to the number of atomising heads required and the dimensions of the AHU/ducts.

## 15. MAIN ADJUSTMENTS

There are fundamentally three components that require adjustments:

- atomising heads;
- air and water lines;
- electronic controller.

### Heads

The screw on the rear of the head is used to adjust the atomised water flow-rate. This is calibrated in the factory to the reference values (2.1 bars air, 0.35 bars water) for the design flow-rate, which may be 2.7; 4.0; 5.4; 6.8 or 10 l/h. If the spray is visibly different in intensity from the other similar heads, or the environmental conditions mean higher or lower absorption, the screw can be adjusted to increase or decrease the water flow-rate.

This operation should only be performed by authorised personnel (CAREL service centres).

### Air and water line

The air and water pressure in the respective lines must have the following values:

- Cabinet air inlet: 5 to 7 bars
- Cabinet air outlet: 2.1 bars
- Cabinet water inlet: 3 to 7 bars
- Water outlet:
  - 0.35 bars if the heads and cabinet are at the same height;
  - $(0.35 + H \times 0.1)$  bars if the heads and cabinet are at different heights. H is the height between the heads and the cabinet water line in metres.



**Note: maximum height between the cabinet and the water line is 20 m.**

The MC modulating humidification system can modulate the production of atomised water by adjusting the air pressure at the heads, allowing a proportional variation in flow-rate.

- The minimum pressure is set as default to 1.2 bars.
- The maximum pressure is set as default to 2.1 bars

These values can be modified so as to optimise:

- the minimum pressure according to the type of atomising head used
- the maximum pressure according to the pressure drop in the line (also see chapters 5.3; 6.2).

in the case of modulating units with pressure transducer at the end of the air line, the maximum pressure is controlled automatically (the transducer is supplied by CAREL as an option).

## 16. MAINTENANCE

### 16.1 Maintenance procedures

Even if the MC humidification system does not generally require special maintenance, preventive maintenance should be performed regularly, annually or before starting each season. The richer the water in salts or impurities, the more frequently checks are required.

#### Devices requiring checks:

**Compressor:** follow the manufacturer's instructions

**Atomising heads:** once a year remove and clean the nozzle, lubricate the o-ring with silicone grease and in case change them.

**Air and water line:** once a year the air and water lines should be bled to remove any sediments, traces of oil and dirt. To do this, follow the system start-up procedure.

**Pressure regulators and solenoid valves:** once a year open and clean to remove any debris and deposits.

**pCO3 electronic controller + pGD terminal and humidity probes:** once a year check the condition of the probes and recalibrate if necessary. Do not use compressed air or solvents to clean the probe sensor.

### 16.2 Kits & optional accessories for the air/ water line (see chap. 2)

NO solenoid valve at end of line for NW (normal water)	M	C	K	D	V	W	L	0	0	0
NO solenoid valve at end of line for AW (aggressive water)	M	C	K	D	V	W	L	0	0	1
pressure transducer l=10 m	M	C	K	P	T	0	1	0	0	0
pressure transducer l=50 m	M	C	K	P	T	0	5	0	0	0
pressure transducer l=100 m	M	C	K	P	T	1	0	0	0	0
air outlet pressure gauge 0 to 4 bars	M	C	K	M	A	0	4	0	0	0
water outlet pressure gauge AW 0 to 2.5 bars	M	C	K	M	W	0	2	5	0	1
UV lamp sanitising kit	M	C	K	S	U	V	0	0	0	0
UV lamp	M	C	K	U	V	0	0	0	0	0
5" water filter container	M	C	F	I	L	W	A	T	0	5
5µ water filter cartridge	M	C	C	0	5	P	P	0	0	5
1/2" air filter	M	C	F	I	L	A	I	R	0	1
3/8" oil filter for air	M	C	F	I	L	O	I	L	0	1
humidity probes for ducts 10 to 90% rH	D	P	D	C	1	1	2	0	0	0
humidity probes for ducts 0 to 100% rH	D	P	D	C	2	1	2	0	0	0
ambient humidity probes 10 to 90% rH	D	P	W	C	1	1	2	0	0	0
temperature-humidity probes for industrial environments -10 to 70 °C/ 0 to 100% rH	D	P	P	C	2	1	2	0	0	0
temperature-humidity probes for industrial environments 0 to 50 °C / 10 to 90% rH	D	P	P	C	1	1	2	0	0	0

### 16.3 Kits & optional accessories for the atomising heads (see chap. 11)

Atomising head assembly kit	M	C	K	1	A	W	0	0	0	0
Atomising head mod. A 2.7 l/h	M	C	A	A	2	0	0	0	0	0
Atomising head mod. B 4.0 l/h	M	C	A	B	2	0	0	0	0	0
Atomising head mod. C 5.4 l/h	M	C	A	C	2	0	0	0	0	0
Atomising head mod. D 6.8 l/h	M	C	A	D	2	0	0	0	0	0
Atomising head mod. E 10 l/h	M	C	A	E	2	0	0	0	0	0

**16.4 Spare parts for air/water line  
(see paragraph 1.4)**

line drawing	code & description	exploded drawing	component code	component description	n.
	<b>MCKA060D00</b> ON/OFF air line 60 l/h		<b>MCKMA12000</b>	pressure gauge 0 to 12 bars	1
			<b>MCKMNF000</b>	manifold	2
			<b>MCKMR0A060</b>	manual air pressure regulator 60 l/h	3
			<b>MCKFSVBC00</b>	NC air solenoid valve 60 l/h/water NW	4
			<b>MCKMA04000</b>	air outlet pressure gauge 0 to 4 bars	5
	<b>MCKA060DU0</b> ON/OFF air line 60 l/h UL		<b>MCKPS00000</b>	pressure switch	6
	<b>MCKA230D00</b> ON/OFF air line 230 l/h		<b>MCKMA12000</b>	pressure gauge 0 to 12 bars	1
			<b>MCKMNF000</b>	manifold	2
			<b>MCKMR0A230</b>	manual air pressure regulator 230 l/h	3
			<b>MCKFSVAC00</b>	NC air solenoid valve 230 l/h	4
			<b>MCKMNF000</b>	manifold	2
	<b>MCKA230DU0</b> ON/OFF air line 230 l/h UL		<b>MCKPS00000</b>	pressure switch	6
	<b>MCKA060H00</b> modulating air line 60 l/h		<b>MCKMA12000</b>	pressure gauge 0 to 12 bars	1
			<b>MCKMNF000</b>	manifold	2
			<b>MCKAMVA000</b>	modulating valve	3
			<b>MCKFSVBC00</b>	NC air solenoid valve 60 l/h/water NW	4
			<b>MCKMNF000</b>	manifold	2
	<b>MCKA060HU0</b> modulating air line 60 l/h UL				
	<b>MCKA230H00</b> modulating air line 230 l/h		<b>MCKMA12000</b>	pressure gauge 0 to 12 bars	1
			<b>MCKMNF000</b>	manifold	2
			<b>MCKAMVA000</b>	modulating valve	3
			<b>MCKFSVAC00</b>	NC air solenoid valve 230 l/h	4
			<b>MCKMNF000</b>	manifold	2
	<b>MCKA230HU0</b> modulating air line 230 l/h UL				
	<b>MCKW000000</b> ON/OFF normal water line 230 l/h		<b>MCKMA12000</b>	pressure gauge 0 to 12 bars	1
			<b>MCKMNF000</b>	manifold	2
			<b>MCKMR0W000</b>	manual water pressure regulator	3
			<b>MCKFSVBC00</b>	NC air solenoid valve 60 l/h/water NW	4
			<b>MCKMW02500</b>	water outlet pressure gauge NW 0 to 2.5 bars	5
			<b>MCKDSVWC00</b>	NO solenoid water valve NW	6
	<b>MCKW0000U0</b> ON/OFF normal water line 230 l/h UL				
	<b>MCKW000001</b> ON/OFF aggressive water line 230 l/h		<b>MCKMW10001</b>	inlet pressure gauge AW 0 to 10 bars	1
			<b>MCKMNF000</b>	manifold	2
			<b>MCKMR0W000</b>	manual water pressure regulator	3
			<b>MCKFSVWC01</b>	NC water solenoid valve AW	4
			<b>MCKMW02501</b>	water outlet pressure gauge AW 0 to 2.5 bars	5
			<b>MCKDSVWC01</b>	NO solenoid water valve AW	6
	<b>MCKW0000U1</b> ON/OFF aggressive water line 230 l/h UL				

cabinet

distribution

maintenance

NC air solenoid valve 60 l/h/water for NW	M	C	K	F	S	V	B	C	0	0
NC air solenoid valve 230 L/h	M	C	K	F	S	V	A	C	0	0
NO water solenoid valve for NW	M	C	K	D	S	V	W	C	0	0
NC water solenoid valve for AW	M	C	K	F	S	V	W	C	0	1
NO water solenoid valve for AW	M	C	K	D	S	V	W	C	0	1
pressure gauge 0 to 12 bars	M	C	K	M	A	1	2	0	0	0
inlet pressure gauge AW 0 to 10 bars	M	C	K	M	W	1	0	0	0	1
air outlet pressure gauge 0 to 4 bars	M	C	K	M	A	0	4	0	0	0
water outlet pressure gauge NW 0 to 2.5 bars	M	C	K	M	W	0	2	5	0	0
water outlet pressure gauge AW 0 to 2.5 bars	M	C	K	M	W	0	2	5	0	1
manual air pressure regulator 60 l/h	M	C	K	M	R	0	A	0	6	0
manual air pressure regulator 230 l/h	M	C	K	M	R	0	A	2	3	0
manual water pressure regulator	M	C	K	M	R	0	W	0	0	0
modulating valve	M	C	K	A	M	V	A	0	0	0

**16.5 Pre-programmed pCO<sup>3</sup> controllers**

pre-programmed pCO <sup>3</sup> controller, 60 l/h ON/OFF Master CE	M	C	K	C	0	6	C	D	M	0
pre-programmed pCO <sup>3</sup> controller, 60 l/h ON/OFF Master UL	M	C	K	C	0	6	C	1	M	0
pre-programmed pCO <sup>3</sup> controller, 60 l/h ON/OFF Slave CE	M	C	K	C	0	6	C	D	S	0
pre-programmed pCO <sup>3</sup> controller, 60 l/h ON/OFF Slave UL	M	C	K	C	0	6	C	1	S	0
pre-programmed pCO <sup>3</sup> controller, 230 l/h ON/OFF Master CE	M	C	K	C	2	3	C	D	M	0
pre-programmed pCO <sup>3</sup> controller, 230 l/h ON/OFF Master UL	M	C	K	C	2	3	C	1	M	0
pre-programmed pCO <sup>3</sup> controller, 230 l/h ON/OFF Slave CE	M	C	K	C	2	3	C	D	S	0
pre-programmed pCO <sup>3</sup> controller, 230 l/h ON/OFF Slave UL	M	C	K	C	2	3	C	1	S	0
pre-programmed pCO <sup>3</sup> controller, 60 l/h modulating Master CE	M	C	K	C	0	6	H	D	M	0
pre-programmed pCO <sup>3</sup> controller, 60 l/h modulating Master UL	M	C	K	C	0	6	H	1	M	0
pre-programmed pCO <sup>3</sup> controller, 60 l/h modulating Slave CE	M	C	K	C	0	6	H	D	S	0
pre-programmed pCO <sup>3</sup> controller, 60 l/h modulating Slave UL	M	C	K	C	0	6	H	1	S	0
pre-programmed pCO <sup>3</sup> controller, 230 l/h modulating Master CE	M	C	K	C	2	3	H	D	M	0
pre-programmed pCO <sup>3</sup> controller, 230 l/h modulating Master UL	M	C	K	C	2	3	H	1	M	0
pre-programmed pCO <sup>3</sup> controller, 230 l/h modulating Slave CE	M	C	K	C	2	3	H	D	S	0
pre-programmed pCO <sup>3</sup> controller, 230 l/h modulating Slave UL	M	C	K	C	2	3	H	1	S	0

**16.6 Electrical panel kit and spare parts  
(see paragraph 1.4)**

manifold	M	C	K	M	N	F	D	0	0	0
pressure switch	M	C	K	P	S	0	0	0	0	0
power supply 110/230 Vac 12 Vdc 0.5 A	M	C	K	A	L	0	0	0	0	0
transformer	M	C	K	T	R	0	0	0	0	0
fuses	M	C	K	F	U	S	E	0	0	0
modulating valve regulator	M	C	K	A	R	V	A	0	0	0
pGD0 kit for setting pLAN address	P	G	D	0	0	0	2	F	0	K

## 17. TROUBLESHOOTING

### 17.1 Troubleshooting table

line	problem	cause	solution
1	alarm status displayed	C1 active alarm	S1 check the alarm in "table of alarms"
2	unit powered and enabled, the switch on the front is in position "1" yet the humidifier won't start.	C1 no power to the cabinet	S1 check that there is power at terminals LN
		C2 the fuses are blown	S2 check the fuses
4	saturation and condensation inside the duct caused by the fan stopping.	C1 failure to detect the flow switch alarm	S1 make sure the flow switch is connected to terminals ID6-COM on the unit
			S2 check the correct configuration of the flow switch alarm contact: installer menu>external alarms.
5	the air outlet pressure doesn't reach 2.1 bars	C1 compressor undersized	S1 check the flow-rate of the compressor in relation to the to the consumption expected for the installation
		C2 for proportional units, without the transducer at the end of the line: maximum limit pressure too low.	S2 check the maximum pressure set: installer menu>operating options
		C3 for ON/OFF units, pressure regulator set too low.	S3 check the calibration of the pressure regulator
6	in proportional systems: the air outlet pressure swings	C1 air line long and made from deformable material	S1 decrease inlet pressure to the cabinet while ensuring the pressure at the heads reaches 2.1 bars
7	air line active yet the heads don't atomise water.	C1 the air outlet pressure is too low	S2.1 ON/OFF unit: check the inlet air pressure and the air pressure regulator
			S2.2 proportional unit, without pressure transducer end of the line: check air pressure limit, installer menu>operating options
		C2 water line NC solenoid valve not powered	S2 check 24 V power to the solenoid valve.
		C3 water line NO solenoid valve not powered	S3 check 24 V power to the solenoid valve.
		C4 water pressure regulator closed (fully unscrewed)	S4 adjust the pressure regulator so the outlet pressure is 0.35 bars
		C5 regulator not adjusted according to the height of the heads	S5 adjust the pressure regulator so the outlet pressure is 0.35 bars plus 0.1 bars for each metre of difference in height between the cabinet and distribution line
8	water pressure reaches high values and is not controlled.	C1 water pressure regulator dirty	S6 remove the water pressure regulator and clean any impurities.
			S1 remove the water pressure regulator and clean any impurities.
9	for duct installations: low absorption of atomised water and area under the atomisation heads wet	C1 air speed in the duct too high in relation to the free path between the atomising heads and droplet separator.	S1 check the sizing of the installation
		C2 overlapping sprays of atomised water or contact between the spray of atomised water and the walls of the duct	S2 optimise the positioning of the heads
10	water leaks from the NO solenoid valve in the cabinet or at the end of the line	C1 impurities in the solenoid valve that prevent complete closing.	S1 remove the solenoid valve, remove the coil, unscrew the sleeve, remove the impurities, clean the body and sleeve and reassemble.
11	with the unit off or in stand-by with the NC solenoid valve closed, water leaks	C1 impurities in the solenoid valve that prevent complete closing.	S1 remove the solenoid valve, remove the coil, unscrew the sleeve, remove the impurities, clean the body and sleeve and reassemble.
12	atomising heads with abnormal flow, adjusting the calibration screw brings no improvement.	C1 atomising heads dirty	S1 remove the head and clean.
		C2 air and water pressure at the heads outside the limits	S2 check the air and water pressure in the cabinet and at the end of the line
		C3 oil in the air line	S3 check the oil separator filter upstream of the cabinet.
13	the heads produce a jet of water when there is no air	C1 air/water connections reversed	S1 reverse the connection observing the markings on the heads
14	the ambient humidity stabilises at values below the set point	C1 the capacity of the installation is not sufficient to meet the requirements	S1.1 review the sizing of the installation
			S2.1 adjust the heads to increase production increase the number of the heads in relation to the maximum flow-rate of the cabinet. See points 8 and 9.











# CAREL

**CAREL INDUSTRIES HQs**  
Via dell'Industria, 11 - 35020 Brugine - Padova (Italy)  
Tel. (+39) 049.9716611 - Fax (+39) 049.9716600  
e-mail: carel@carel.com - www.carel.com

Agenzia / Agency: