

pRack pR100

compressor rack controller

CAREL



User manual

**LEGGI E CONSERVA
QUESTE ISTRUZIONI**

**READ AND SAVE
THESE INSTRUCTIONS**



READ CAREFULLY IN THE TEXT!

IMPORTANT



CAREL bases the development of its products on decades of experience in HVAC, on the continuous investments in technological innovations to products, procedures and strict quality processes with in-circuit and functional testing on 100% of its products, and on the most innovative production technology available on the market. CAREL and its subsidiaries nonetheless cannot guarantee that all the aspects of the product and the software included with the product respond to the requirements of the final application, despite the product being developed according to start-of-the-art techniques.

The customer (manufacturer, developer or installer of the final equipment) accepts all liability and risk relating to the configuration of the product in order to reach the expected results in relation to the specific final installation and/or equipment. CAREL may, based on specific agreements, act as a consultant for the positive commissioning of the final unit/application, however in no case does it accept liability for the correct operation of the final equipment/system.

The CAREL product is a state-of-the-art product, whose operation is specified in the technical documentation supplied with the product or can be downloaded, even prior to purchase, from the website www.CAREL.com.

Each CAREL product, in relation to its advanced level of technology, requires setup / configuration / programming / commissioning to be able to operate in the best possible way for the specific application. The failure to complete such operations, which are required/indicated in the user manual, may cause the final product to malfunction; CAREL accepts no liability in such cases.

Only qualified personnel may install or carry out technical service on the product. The customer must only use the product in the manner described in the documentation relating to the product.

In addition to observing any further warnings described in this manual, the following warnings must be heeded for all CAREL products:

- Prevent the electronic circuits from getting wet. Rain, humidity and all types of liquids or condensate contain corrosive minerals that may damage the electronic circuits. In any case, the product should be used or stored in environments that comply with the temperature and humidity limits specified in the manual.
- Do not install the device in particularly hot environments. Too high temperatures may reduce the life of electronic devices, damage them and deform or melt the plastic parts. In any case, the product should be used or stored in environments that comply with the temperature and humidity limits specified in the manual.
- Do not attempt to open the device in any way other than described in the manual.
- Do not drop, hit or shake the device, as the internal circuits and mechanisms may be irreparably damaged.
- Do not use corrosive chemicals, solvents or aggressive detergents to clean the device.
- Do not use the product for applications other than those specified in the technical manual.

All of the above suggestions likewise apply to the controllers, serial boards, programming keys or any other accessory in the CAREL product portfolio. CAREL adopts a policy of continual development. Consequently, CAREL reserves the right to make changes and improvements to any product described in this document without prior warning.

The technical specifications shown in the manual may be changed without prior warning.

The liability of CAREL in relation to its products is specified in the CAREL general contract conditions, available on the website www.CAREL.com and/or by specific agreements with customers; specifically, to the extent where allowed by applicable legislation, in no case will CAREL, its employees or subsidiaries be liable for any lost earnings or sales, losses of data and information, costs of replacement goods or services, damage to things or people, downtime or any direct, indirect, incidental, actual, punitive, exemplary, special or consequential damage of any kind whatsoever, whether contractual, extra-contractual or due to negligence, or any other liabilities deriving from the installation, use or impossibility to use the product, even if CAREL or its subsidiaries are warned of the possibility of such damage.

DISPOSAL



INFORMATION FOR USERS ON THE CORRECT HANDLING OF WASTE ELECTRICAL AND ELECTRONIC EQUIPMENT (WEEE)

In reference to European Union directive 2002/96/EC issued on 27 January 2003 and the related national legislation, please note that:

- WEEE cannot be disposed of as municipal waste and such waste must be collected and disposed of separately;
- the public or private waste collection systems defined by local legislation must be used. In addition, the equipment can be returned to the distributor at the end of its working life when buying new equipment;
- the equipment may contain hazardous substances: the improper use or incorrect disposal of such may have negative effects on human health and on the environment;
- the symbol (crossed-out wheeled bin) shown on the product or on the packaging and on the instruction sheet indicates that the equipment has been introduced onto the market after 13 August 2005 and that it must be disposed of separately;
- in the event of illegal disposal of electrical and electronic waste, the penalties are specified by local waste disposal legislation.

Warranty on the materials: 2 years (from the date of production, excluding consumables).

Approval: the quality and safety of CAREL INDUSTRIES Hqs products are guaranteed by the ISO 9001 certified design and production system.

WARNING: separate as much as possible the probe and digital input signal cables from the cables carrying inductive loads and power cables to avoid possible electromagnetic disturbance.
Never run power cables (including the electrical panel wiring) and signal cables in the same conduits.

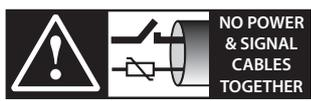

NO POWER & SIGNAL CABLES TOGETHER

READ CAREFULLY IN THE TEXT!

Key icone		
	NOTE:	to bring attention to a very important subject; in particular, regarding the practical use of the various functions of the product.
	IMPORTANT:	to bring critical issues regarding the use of the pRack PR100 to the attention of the user.
	TUTORIAL:	some simple examples to accompany the user in configuring the most common settings.

Content

1. INTRODUCTION	7
1.1 Main features	7
1.2 Components and accessories.....	7
1.3 System configurations and input and output configuration	9
2. HARDWARE FEATURES AND INSTALLATION	10
2.1 Description of the pRack PR100 Compact	10
2.2 Description of the pRack PR100 S, M, L, XL boards	14
2.3 pRACK pR100 board general connection diagram.....	20
3. INSTALLATION	22
3.1 General installation instructions	22
3.2 Power supply	22
3.3 Connecting the analogue inputs.....	22
3.4 Connecting the digital inputs	24
3.5 Connecting the analogue outputs	25
3.6 Connecting the digital outputs.....	26
3.7 pLAN electrical connections	27
4. START UP	28
4.1 Starting the first time	28
5. USER INTERFACE	30
5.1 Graphic terminal.....	30
5.2 Description of the display	30
5.3 Password.....	31
5.4 Description menu	31
6. FUNCTIONS	33
6.1 Unit On-Off.....	33
6.2 Control	33
6.3 Compressors.....	35
6.4 Fans.....	40
6.5 Energy saving	42
6.6 Accessory functions.....	43
6.7 Settings.....	47
6.8 Managing the default values	47
7. PARAMETERS TABLE	48
8. ALARMS	69
8.1 Alarm management	69
8.2 Compressor alarms	69
8.3 Pressure and prevent alarms.....	70
9. SUPERVISORY AND COMMISSIONING SYSTEMS	72
9.1 PlantVisor PRO and PlantWatch PRO supervisory systems	72
9.2 Commissioning software	72
10. UPDATING THE SOFTWARE	73
10.1 Updating using pRack Manager	73
10.2 Updating using SmartKey.....	73
10.3 Saving parameters between different software versions	73
11. APPENDIX	74

1. INTRODUCTION

1.1 Main features

List of functions:

Main characteristics	Up to 2 suction lines and 2 condenser lines
	Management of scroll, piston, digital scroll, screw compressors
	Up to 12 scroll or piston compressors per line
	Up to 2 screw compressors for line 1, maximum one line with screw compressors
	Up to 16 fans per line
	Inverter on suction and condenser lines
	Generic functions configurable by the user (ON/OFF, modulation, alarms, time bands)
Hardware	Heat recovery
	Compact, S, M, L, XL versions
Languages	Built-in or external pGD1
	Italian
	English
Unit of measure	Note: other languages available as standard, downloadable from ksa.carel.com
	Temperature: °C, °F
Control	Pressure: barg, psig (all pressure values are also converted to temperature)
	Date format settable between: dd/mm/yy, mm/dd/yy, yy.mm.dd
Compressor rotation	Proportional band (P, PI) available for compressors and fans
	Neutral zone available for compressors and fans
Scheduling by calendar	FIFO
	LIFO
	Timed
	Fixed (the on/off order can be set as required)
Set point	Scheduling available: heating/cooling, 4 daily time bands, 5 special periods (e.g.: closing period), 10 special days (e.g.: holidays)
	Schedulable functions: set point compensation for compressors and fans, split condenser (heating/cooling only), anti noise, heat recovery, generic functions
Prevention	Compensation from digital input, from scheduling, floating based on supervisor parameter (compressors) or outside temperature (fans)
Alarms	High pressure, including activation of heat recovery or ChillBooster
	Automatic and manual management
	Configurable compressor alarms
Supervisor protocol	Double Signal on digital outputs for high or low priority alarms
	Log from application
Supervisor protocol	Carel
	Modbus®

Tab. 1.a

1.2 Components and accessories

pRack PR100 is available in 5 hardware sizes, listed in the table (for the detailed description of each size, the electrical specifications and installation see Chapter 2.):

Hardware Sizes:

Size	Analogue inputs available	Digital inputs available	Analogue outputs available	Digital outputs available
Compact	2 + 6 (*)	2	1 (PWM) + 1 (0-10 Vdc)	5 + 2 (SSR, depending on model)
Small	3 + 2 (*)	8	4 (0-10 Vdc)	6 + 2 (SSR, depending on model)
Medium	6 + 2 (*)	12 (24 V) + 2 (230 V)	4 (0-10 Vdc)	11 + 2 (SSR, depending on model)
Large	6 + 4 (*)	14 (24 V) + 4 (230 V)	6 (0-10 Vdc)	14 + 4 (SSR, depending on model)
Extra large NO	6 + 2 (*)	12 (24 V) + 2 (230 V)	4 (0-10 Vdc)	25 + 4 (SSR, depending on model)

Tab. 1.b

(*) can also be used as digital inputs

The following versions are available for each size:

- with built-in or external PGD1 terminal, white background, without terminal
- with RS485 serial interface incorporated, without serial interface
- with or without SSR digital outputs.

All models of pRack PR100 come with:

- optically-isolated pLAN
- black plastic cover
- maximum number of SSR relays available (for models with SSR)
- connector kit.

Below are the codes of the models with RS485 serial (with or without SSR), without RS485 serial (with or without SSR), the spare parts and accessories.

Models with RS485 serial:

Size	Code	Description
Compact	PRK100X3B0	pRack PR100 compact, built-in white PGD1, RS485, 2 SSR, connector kit
	PRK100X3BK	pRack PR100 compact, external white pGD1 with connection cable, RS485, 2 SSR, connector kit
	PRK100X3D0	pRack PR100 compact, built-in white PGD1, RS485, connector kit
	PRK100X3DK	pRack PR100 compact, external white pGD1 with connection cable, RS485, connector kit
Small	PRK100S3B0	pRack PR100 small, built-in white PGD1, RS485, 2 SSR, connector kit
	PRK100S3BK	pRack PR100 small, external white pGD1 with connection cable, RS485, 2 SSR, connector kit
	PRK100S3D0	pRack PR100 small, built-in white PGD1, RS485, connector kit
	PRK100S3DK	pRack PR100 small, external white pGD1 with connection cable, RS485, connector kit
Medium	PRK100M3B0	pRack PR100 medium, built-in white PGD1, RS485, 2 SSR, connector kit
	PRK100M3BK	pRack PR100 medium, external white pGD1 with connection cable, RS485, 2 SSR, connector kit
	PRK100L3B0	pRack PR100 large, built-in white PGD1, RS485, 4 SSR, connector kit
Large	PRK100L3BK	pRack PR100 large, external white pGD1 with connection cable, RS485, 4 SSR, connector kit
	PRK100L3DK	pRack PR100 large, external white pGD1 with connection cable, RS485, connector kit
	PRK100Z3B0	pRack PR100 XL NO, built-in white PGD1, RS485, 4 SSR, connector kit
Extra large NO	PRK100Z3BK	pRack PR100 XL NO, external white pGD1 with connection cable, RS485, 4 SSR, connector kit
	PRK100S3AK	pRack PR100 XL NO, external white pGD1 with connection cable, RS485, 4 SSR, connector kit

Tab. 1.c

Models without RS485 serial:

Size	Code	Description
Small	PRK100S3A0	pRack PR100 small, built-in white PGD1, 2 SSR, connector kit
	PRK100S3AK	pRack PR100 small, external white pGD1 with connection cable, 2 SSR, connector kit
	PRK100S3C0	PR100 small, built-in white PGD1, connector kit
	PRK100S3CK	PR100 small, external white pGD1 with connection cable, connector kit
Medium	PRK100M3A0	pRack PR100 medium, built-in white PGD1, 2 SSR, connector kit
	PRK100M3AK	pRack PR100 medium, external white pGD1 with connection cable, 2 SSR, connector kit
	PRK100M3C0	pRack PR100 medium, built-in white PGD1, connector kit
	PRK100M3CK	pRack PR100 medium, external white pGD1 with connection cable, connector kit
Large	PRK100L3A0	pRack PR100 large, built-in white PGD1, 4 SSR, connector kit
	PRK100L3AK	pRack PR100 large, external white pGD1 with connection cable, 4 SSR, connector kit
Extra large NO	PRK100Z3A0	pRack PR100 XL NO, built-in white PGD1, 4 SSR, connector kit
	PRK100Z3A0	pRack PR100 XL NO, external white pGD1 with connection cable, 4 SSR, connector kit

Tab. 1.d

Spare parts:

Code	Description
PRK100X0A0	pRack PR100 compact, without terminal, 2 SSR, connector kit
PRK100X0B0	pRack PR100 compact, without terminal, RS485, 2 SSR, connector kit
PRK100X0C0	pRack PR100 compact, without terminal, connector kit
PRK100X0D0	pRack PR100 compact, without terminal, RS485, connector kit
PRK100S0A0	pRack PR100 small, without terminal, 2 SSR, connector kit.
PRK100S0B0	pRack PR100 small, without terminal, RS485, 2 SSR, connector kit
PRK100S0C0	pRack PR100 small, without terminal, connector kit
PRK100S0D0	pRack PR100 small, without terminal, RS485, connector kit
PRK100M0A0	pRack PR100 medium, without terminal, connector kit, 2 SSR
PRK100M0B0	pRack PR100 medium, without terminal, RS485, connector kit, 2 SSR
PRK100L0A0	pRack PR100 large, without terminal, connector kit, 4 SSR
PRK100L0B0	pRack PR100 large, without terminal, RS485, connector kit, 4 SSR
PRK100Z0A0	pRack PR100 XL, without terminal, connector kit, 4 SSR
PRK100Z0B0	pRack PR100 XL, without terminal, RS485, connector kit, 4 SSR

Tab. 1.e

Accessories:

Code	Description
PGD1Rk0FX0	PGD1 user terminal for pRack PR100
CONV0/10A0	Module for converting a PWM output to a liner 0...10V and 4...20 mA analogue output
CONVONOFF0	Module for converting a 0...10V analogue output to an SPDT digital output
PCOS004850	RS485 serial connection card
CVSTDUTLFO	USB/RS485 serial converter with telephone connector
CVSTDUMORO	USB/RS485 serial converter with 3 pin terminal
PCOS00AKY0	Smart key (programming key)
PCOS00AKC0	PC Smart Key USB converter
S90CONN002	Terminal connection cable l=0,8 m
S90CONN000	Terminal connection cable l=1.5 m
S90CONN001	Terminal connection cable l=3 m
SPKT*R* e SPKC00*	0 to 5 Vdc ratiometric pressure probes
SPK*C*, SPK1*, SPK2*, SPK3*	4...20 mA active pressure probes
NTC*	NTC temperature probes -50T90°C
NTC*HT*	NTC temperature probes -0T150°C

Tab. 1.f

1.3 System configurations and input and output configuration

pRack PR100 manages 35 possible system configurations, with up to 2 suction lines and up to 2 condenser lines, on individual boards or on more than one board connected in a pLAN network.

The configuration of the inputs and outputs therefore varies according to the selected system configuration.

Note: Each input/output can be fully configured, with the only limits being set by the system configuration; for example, the suction pressure probe on line 1 can be configured on any one of the analogue inputs that is compatible with the type of probe on the pLAN board with address 1.

pRack PR100 also provides fourteen configurations pre-loaded in the software. These configurations are complete with all the parameters need to start the unit. For the details on the pre-configurations available, see the Quick Guide +040000070.

For further details on selecting the system configuration and the pre-configurations see Chapter 4.

1.3.1 System configurations available

pRack PR100 can manage system configurations with up to 2 suction lines (maximum 12 scroll or piston compressors for lines 1 and 2 or 2 screw compressors for line 1) and up to 2 condenser lines (maximum 16 fans per line). When there are two suction lines, the lines can be managed by the same pRack board or by separate boards. The condenser lines can be managed by the board that manages the suction line, or by separate boards, in accordance with the number of inputs/outputs available.

For each line, both suction and condensing, pRack PR100 can manage a modulating device (inverter, Digital Scroll® compressor or compressor with continuous control).

pRack PR100 manages up to 1 line with screw compressors and each board can control up to 2 compressors.

Some examples of the system configurations managed are shown below, while for the complete list of the configurations and the related features, see Appendix A1.

Example 1: 1 suction line with scroll or piston compressors, 1 condenser line:

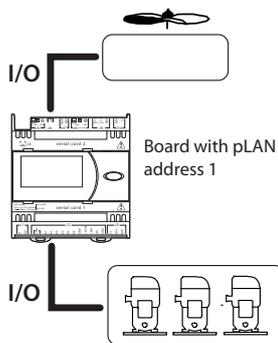

Fig. 1.a

Example 2: 2 suction lines on the same board with scroll or piston compressors, 1 condenser line:

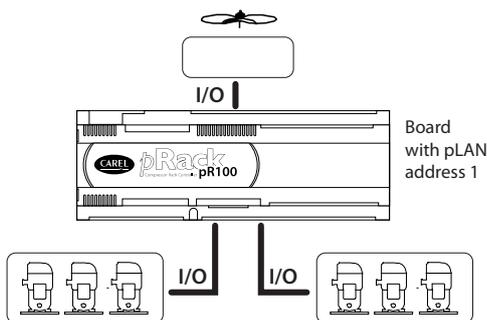

Fig. 1.b

Example 3: 2 suction lines on the same board with scroll or piston compressors, 2 condenser lines on the same board:

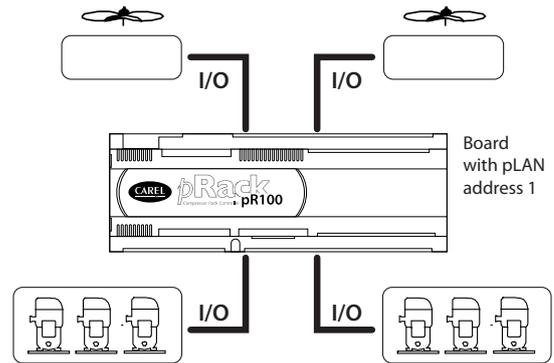

Fig. 1.c

Example 4: 2 suction lines on separate boards (scroll or piston compressors), 2 condenser lines (one for each suction line board)

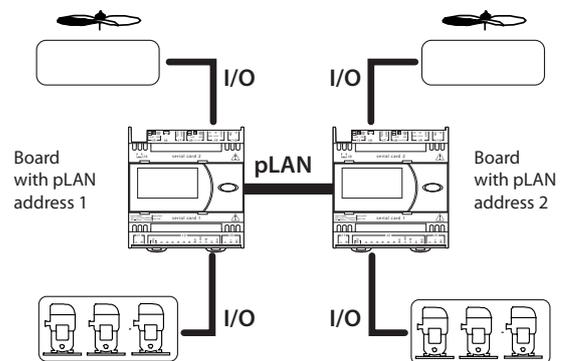

Fig. 1.d

Example 5: 2 suction lines on separate boards with scroll or piston compressors, 2 condenser lines on separate boards:

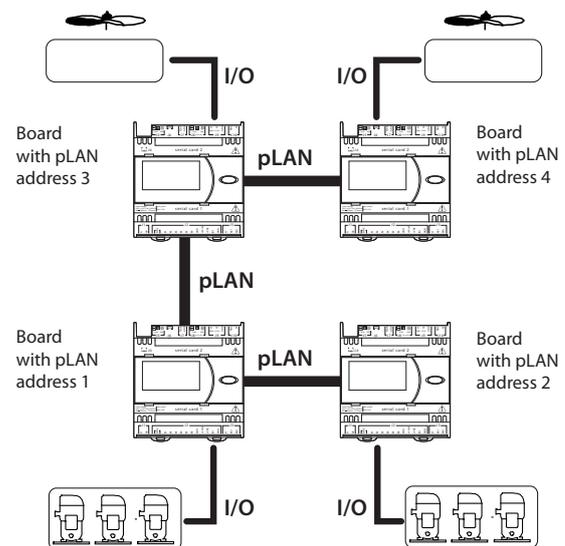

Fig. 1.e

Note: if connecting more than one pRack pR100 board in a pLAN, mixed networks cannot be created combining Compact boards and S, M, L, XL boards, while mixed networks are possible using combinations of the latter models only.

Important: all the boards connected to the pLAN must have the same software revision.

2. HARDWARE FEATURES AND INSTALLATION

2.1 Description of the pRack PR100 Compact

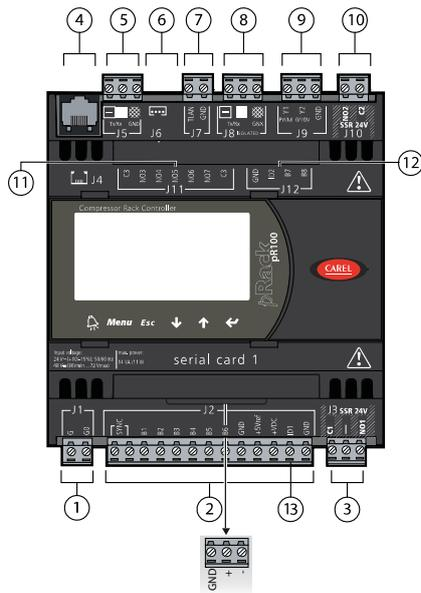

Fig. 2.a

Key

1	power supply connector (G+, G0-) 24 Vac or 36 Vmin to 72 Vmax
2	"SYNC" synchronicity inputs for phase control; NTC, 0 to 1 V, 0 to 5 V, 0 to 20 mA, 4 to 20 mA analogue inputs; +5 Vref to supply 5 V ratiometric probes; +VDC (+21 Vdc) for power to active probes; digital input
3	24 Vac/Vdc SSR or SPDT digital output (based on the model)
4	connector for pGD1 terminal and for downloading the application program
5	pLAN network connector
6	connector for pLD terminals (not used)
7	tLAN network connector (not used)
8	optically-isolated "Field-bus" serial connector
9	0 to 10 V analogue and PWM / phase control outputs
10	24 Vac/Vdc SSR or SPDT digital output (based on the model)
11	SPST relay digital outputs
12	NTC analogue inputs and digital input
13	cover for inserting supervisor and telemaintenance option or "BMS" serial connector (available on models PRK100**B* & PRK100**D*)

2.1.1 Meaning of the inputs/outputs on the pRack PR100 Compact board

Connettore	Segnale	Description
J1-1	G	24 Vac or 36/72 Vdc power supply
J1-2	G0	power supply reference
J2-1	SYNC	synchronicity input for phase control (G0 is the reference)
J2-2	B1	universal analogue input 1 (NTC, 0 to 1 V, 0 to 5 V ratiometric, 0...10 V, 0...20 mA, 4...20 mA)
J2-3	B2	universal analogue input 2 (NTC, 0 to 1 V, 0 to 5 V ratiometric, 0...10 V, 0...20 mA, 4...20 mA)
J2-4	B3	universal analogue input 3 (NTC, 0/1 V, PT1000)
J2-5	B4	universal analogue input 4 (NTC, 0/1 V, PT1000)
J2-6	B5	universal analogue input 5 (NTC, 0 to 1 V, 0 to 5 V ratiometric, 0 to 10 V, ON/OFF)
J2-7	B6	universal analogue input 6 (NTC, 0 to 1 V, 0 to 5 V ratiometric, 0 to 10 V, ON/OFF)
J2-6	GND	analogue input reference
J2-8	+5Vref	power supply for 0/5 V ratiometric probes
J2-9	+VDC	21 Vdc power supply for active probes
J2-10	ID1	digital input no. 1
J2-11	GND	common for digital inputs and analogue inputs
J3-1	C1	common for relay: 1
J3-2	---/NC1(*)	not used/ normally closed contact, relay no. 1 (*)
J3-3	NO1	normally open contact, relay no. 1/ normally open contact, relay no. 1 SSR 24 Vac/Vdc (*)
J4		6-pin telephone connector for connecting the standard user terminal
J5-1	RX-/TX-	RX-/TX- connector for RS485 connection to the pLAN network
J5-2	RX+/TX+	RX+/TX+ connector for RS485 connection to the pLAN network
J5-3	GND	reference for RS485 connection to the pLAN network
J6		4-pin connector for connecting the user terminal pLD (not used)
J7-1	tLAN	tLAN network connector
J7-2	GND	tLAN network connection reference
J8-1	RX-/TX-	RX-/TX- connector for RS485 connection to the optically-isolated "Field-bus" network
J8-2	RX+/TX+	RX+/TX+ connector for RS485 connection to the optically-isolated "Field-bus" network
J8-3	GND	reference for RS485 connection to the optically-isolated "Field-bus" network
J9-1	Y1	analogue output no. 1 PWM (for phase cutting speed controllers)
J9-2	Y2	analogue output no. 2 0/10V
J9-3	GND	analogue output reference
J10-1	NO2	normally open contact, relay no. 2/ normally open contact, relay no. 2 SSR 24 Vac/Vdc (*)
J10-2	C2	common for relay: 2
J11-1	C3	common for relays: 3, 4, 5, 6, 7
J11-2	NO3	normally open contact, relay no. 3
J11-3	NO4	normally open contact, relay no. 4
J11-4	NO5	normally open contact, relay no. 5
J11-5	NO6	normally open contact, relay no. 6
J11-6	NO7	normally open contact, relay no. 7
J11-7	C3	common for relays: 3, 4, 5, 6, 7
J12-1	GND	common for digital inputs and analogue inputs
J12-2	ID2	passive analogue input 7 (NTC, ON/OFF)
J12-3	B7	passive analogue input 8 (NTC, ON/OFF)
J12-4	B8	passive analogue input 8 (NTC, ON/OFF)

(*) depending on the model

Tab. 2.a

2.1.2 Technical specifications of the pRack PR100 Compact board

Analogue inputs

Analogue conversion	10-bit A/D converter embedded in CPU
Maximum number	8
Type	Universal: 2 (inputs B1, B2) - CAREL NTC (-50T90°C; R/T 10 kΩ±1% at 25°C), NTC HT0T150 °C - Voltage 0 to 1 Vdc, 0...10 Vdc, 0 to 5 Vdc ratiometric - Current 0...20 mA or 4...20 mA. Input Resistance: 100 Ω Universal: 2 (inputs B3, B4) - CAREL NTC (-50T90°C; R/T 10 kΩ±1% at 25°C) NTC HT0T150 °C - Voltage 0 to 1 Vdc - PT1000 (-100T200 °C; R/T 1000 Ω at 0°C) Universal: 2 (inputs B5, B6) - CAREL NTC (-50T90°C; R/T 10 kΩ±1% at 25°C) NTC HT0T150 °C - Voltage 0 to 1 Vdc, 0...10 Vdc, 0 to 5 Vdc ratiometric - Voltage-free digital inputs, 5 mA Passive: 2 (inputs B7, B8) - CAREL NTC (-50T90°C; R/T 10kΩ±1% at 25°C) NTC HT0T150 °C - Voltage-free digital inputs, 5 mA Selectable via software
Time constant	0,5 s
Input precision	± 0.3 % of full scale
Classification of the measurement circuits	Category 1 (IEC EN 61010-1)

Tab. 2.b

Important: the 21 Vdc available at terminal +VDC (J2) can be used to power any active probes. The maximum current is I_{max}=60 mA, thermally protected against short-circuits. To power the 0 to 5 Vdc ratiometric probes, use the 5V available at terminal +5Vref (J2). The maximum current is I_{max}=60 mA, thermally protected against short-circuits.

Digital inputs

Type	Not optically-isolated, voltage-free contact	
Maximum number	6: 2 + 4 multifunction analogue inputs	
Minimum digital input impulse detection time	Normally open (open-closed-open)	250 ms
	Normally closed (closed-open-closed)	250 ms
Power supply	internal	

Tab. 2.c

Analogue outputs

Type	Not optically-isolated
Maximum number	2: 1 PWM phase control output (Y1) with 5V pulse of programmable duration and 1 x 0 to 10 Vdc output (Y2)
Power supply	internal
Precision	± 2% of full scale on Y2
Resolution	8 bit
Settling time	2 s on Y2
Maximum load	1 kΩ (10 mA) for 0...10 Vdc and 470 Ω (10 mA) for PWM

Tab. 2.d

Note: the synchronicity for the PWM phase control output is taken from the SYNC input and G0 (J2).

Digital outputs

Important: The outputs can be divided into groups, depending on the insulation distance. The relays belonging to the same group have basic insulation between each other and therefore must have the same power supply (24 Vac or 110 to 230 Vac). Between groups there is double insulation and consequently these may have different voltages.

Models PRK100X*A* & PRK100X*B*

Makeup of the groups	Type of relay	Group 1 (J3)	Group 2 (J10)	Group 3 (J11)
		Type A Available with NC and NO contacts	Type A Available with NO contacts	Type B Available with NO contacts
Features		MOSFET photovoltaic relay Operating voltage 24 Vac/Vdc Maximum power 10 W		SPST, 1250 VA, 250 Vac, 5 A resistive. UL873: 1 A resistive, 1 A FLA, 6 A LRA, 250 Vac, D300 pilot duty (30.000 cycles). EN 60730-1: 1 A resistive, 1 A inductive, cosφ=0.6, 1(1) A (100.000 cycles)
Maximum number	7			
No. of changeover contacts	None			
Number of SSR outputs	2: outputs NO1 and NO2 (J3 and J10)			

Tab. 2.e

Models PRK100X*C* & PRK100X*D*

Makeup of the groups	Type of relay	Group 1 (J3)	Group 2 (J10)	Group 3 (J11)
		Type A Available with NC and NO contacts	Type A Available with NO contacts	Type B Available with NO contacts
Features		SPDT: UL873: 2.5 A resistive, 2 A FLA, 12 A LRA, 250 Vac, C300 pilot duty (30.000 cycles) EN 60730-1: 2 A resistive, 2 A inductive, $\cos\phi=0.6$, 2 (2) A (100.000 cycles)		SPST: UL873: 1 A resistive, 1 A FLA, 6 A LRA, 250 Vac, D300 pilot duty (30.000 cycles). EN 60730-1: 1 A resistive, 1 A inductive, $\cos\phi=0.6$, 1(1) A (100.000 cycles)
Maximum number	7			
No. of changeover contacts	1 (J3)			
Number of SSR outputs	None			

Tab. 2.f



Important: the groups that the digital outputs are divided into have two common pole terminals to simplify wiring. Make sure that the current running through the common terminals does not exceed the rated current of an individual terminal, that is, 8 A.
To connect the digital outputs use a cable with minimum cross-section of 1.5 mm².

The following rules must be observed for the SSR digital outputs, otherwise they may be damaged:

- control only resistive loads with a maximum power of 10 W;
- to control inductive loads, use an external relay;
- to power resistive loads or the external relay use the same power supply as pRack Compact (terminals G-G0) that must be dedicated and not common with other devices (in the case of external SSRs the voltage supplied by pRack to the +Vdc terminal can be used, after having checked the maximum current draw of the active probes and the SSRs).

For the connection diagrams, see the paragraph 3.6.2.

2.1.3 Electrical specifications of the pRack PR100 Compact board

Isolated power supply	24 Vac +10/-15 % 50/60 Hz, at least 30 VA for each board and 48 Vdc (36 Vmin...72 Vmax),
Maximum current	P=11 W, P=14 VA, I _{max} =700 mA
Terminal block	with male/female plug-in connectors (250 Vac max, 8 A max)
Cable cross-section	min 0.5 mm ² – max 2.5 mm ²
CPU	H8SX/1651 32 bit, 50 MHz
Program memory (FLASH)	2+2 MByte
Data memory (SRAM)	512 Kbyte at 16 bit
Parameter data memory (EEPROM)	13 Kbyte +32 Kbyte
NAND FLASH memory	32 MByte
Working cycle duration	0.5 s (application of average complexity)
Clock with battery	Available as standard and integrated into main board
Battery	Lithium button battery, code CR2430, voltage 3 Vdc, dimensions 24x3 mm

Tab. 2.g

2.1.4 Mechanical specifications of the pRack PR100 Compact board

Physical dimensions	6 DIN modules: 105x110x60 mm	
Plastic case	Assembly	Fitted on DIN rail as per DIN 43880 and IEC EN 50022
	Material	technopolymer
	Flame retardance	V2 (UL94) and 960°C (IEC 695)
	Ball pressure test	125 °C
	Resistance to creeping current	≥ 250 V
	Colour	Grey RAL7016

Tab. 2.h

2.1.5 Other specifications of the pRack PR100 Compact board

Operating conditions	-10T60 °C, 90% RH non-condensing	
Storage conditions	-20T70 °C, 90% RH non-condensing	
Index of protection	IP20, IP40 on the front panel only	
Environmental pollution	2	
Class according to protection against electric shock	to be integrated into Class 1 and/or 2 appliances	
Period of stress across the insulating parts	long	
Type of action	1C	
Type of disconnection or microswitching	microswitching	
Category of Resistance to heat and fire	Category D (UL94-V0)	
Immunity against voltage surges	Category 1I	
Ageing characteristics (operating hours)	80.000	
No. of automatic operating cycles	100.000 (EN 60730-1); 30.000 (UL 873)	
Software class and structure	Class A	
Category of immunity to voltage surges (IEC EN 61000-4-5)	Category 2 (IEC EN 61000-4-5)	
Clock	Error at 25°C	±5.3 min/year
	Error in the temperature range -10T60 °C	±27 min/year
	Ageing	< ± 5ppm (±2.7min/year)
	Battery duration	typically 6 months (8 months maximum)
	Recharge time	typically 5 hours (< 8 hours maximum)

Tab. 2.i

2.1.6 pRack PR100 Compact board dimensions

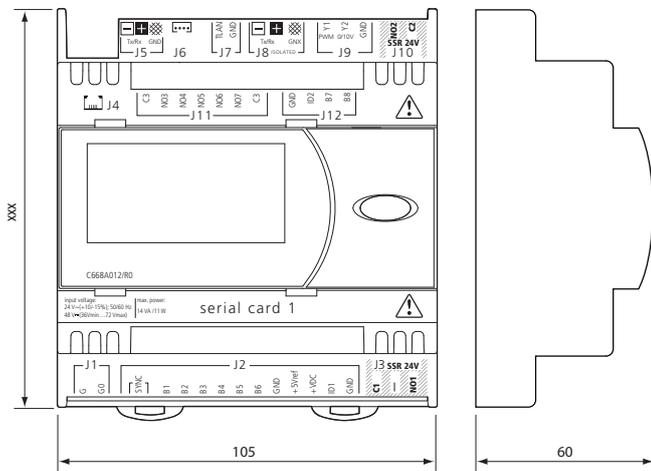

Fig. 2.b

pRack PR100 Compact product certification

UL 873 and C22.2 No. 24-93: "Temperature-indicating and regulating equipment".
CE directives (LVD/EMC).

2.2 Description of the pRack PR100 S, M, L, XL boards

pRack PR100 S

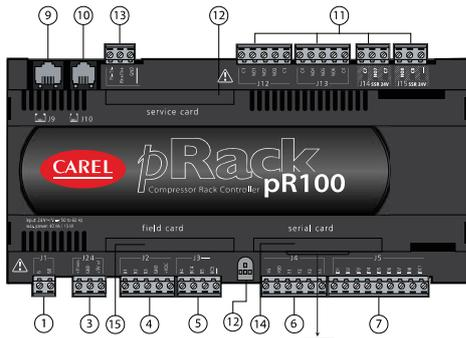

Fig. 2.c

pRack PR100 M

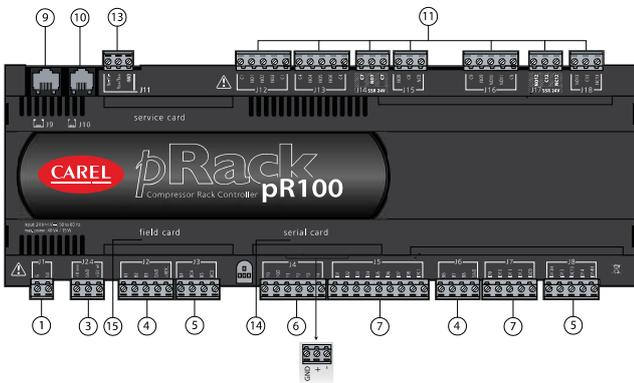

Fig. 2.d

pRack PR100 L

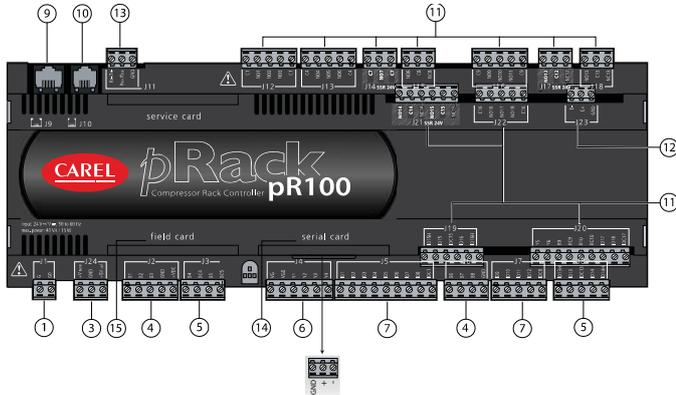

Fig. 2.e

pRack PR100 XL

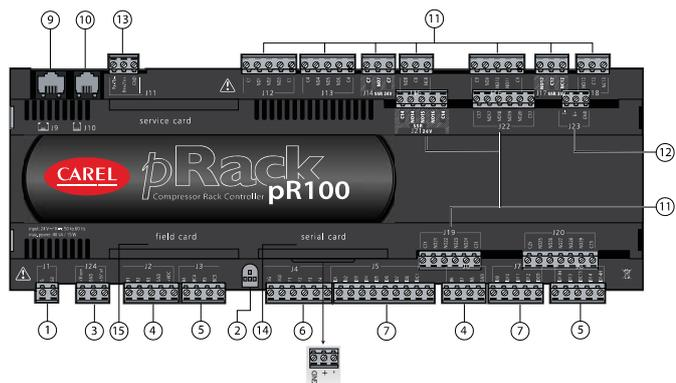

Fig. 2.f

Key

1	power supply connector (G+, G0-)
2	yellow power LED and 3 status LEDs;
3	additional power supply for the terminal and 0 to 5 V ratiometric probes;
4	universal NTC, 0...1 V, 0...5 V - ratiometric, 0...10 V, 0...20 mA, 4...20 mA analogue inputs;
5	passive NTC, PT1000, ON/OFF analogue inputs;
6	0...10 V analogue outputs;
7	24 Vac/Vdc digital inputs;
8	230 Vac or 24 Vac/Vdc digital inputs;
9	display terminal connector (not used);
10	connector for pGD1 terminal and for downloading the application program
11	relay digital outputs, SPST, 24 Vac/Vdc SSR or SPDT (depending on the model)
12	I/O expansion board connector (not used);
13	pLAN network connector;
14	cover for inserting the supervisor and telemaintenance option or "BMS" serial connector (available on models PRK100**B* and PRK100**D*);
15	cover for inserting the field card option

Tab. 2.j

2.2.1 Meaning of the inputs/outputs on the pRack PR100 S, M, L, XL boards

Version	Connector	Signal	Description	
S, M, L, XL	J1-1	G	+24 Vdc or 24 Vac power supply	
	J1-2	G0	power supply reference	
	J2-1	B1	universal analogue input 1 (NTC, 0 to 1 V, 0 to 5 V ratiometric, 0...10 V, 0...20 mA, 4...20 mA)	
	J2-2	B2	universal analogue input 2 (NTC, 0 to 1 V, 0 to 5 V ratiometric, 0...10 V, 0...20 mA, 4...20 mA)	
	J2-3	B3	universal analogue input 3 (NTC, 0 to 1 V, 0 to 5 V ratiometric, 0...10 V, 0...20 mA, 4...20 mA)	
	J2-4	GND	common for analogue inputs	
	J2-5	+VDC	21 Vdc power supply for active probes (maximum current 200 mA)	
	J3-1	B4	passive analogue input 4 (NTC, PT1000, ON/OFF)	
	J3-2	BC4	common for analogue input 4	
	J3-3	B5	passive analogue input 5 (NTC, PT1000, ON/OFF)	
	J3-4	BC5	common for analogue input 5	
	J4-1	VG	power to optically-isolated analogue output, 24 Vac/Vdc	
	J4-2	VG0	power to optically-isolated analogue output, 0 Vac/Vdc	
	J4-3	Y1	analogue output no. 1, 0...10 V	
	J4-4	Y2	analogue output no. 2, 0...10 V	
	J4-5	Y3	analogue output no. 3, 0...10 V	
	J4-6	Y4	analogue output no. 4, 0...10 V	
	J5-1	ID1	digital input no. 1, 24 Vac/Vdc	
	J5-2	ID2	digital input no. 2, 24 Vac/Vdc	
	J5-3	ID3	digital input no. 3, 24 Vac/Vdc	
	J5-4	ID4	digital input no. 4, 24 Vac/Vdc	
	J5-5	ID5	digital input no. 5, 24 Vac/Vdc	
	J5-6	ID6	digital input no. 6, 24 Vac/Vdc	
	J5-7	ID7	digital input no. 7, 24 Vac/Vdc	
	J5-8	ID8	digital input no. 8, 24 Vac/Vdc	
	J5-9	IDC1	common for digital inputs from 1 to 8 (negative pole for DC power supply)	
	M, L, XL	J6-1	B6	universal analogue input 6 (NTC, 0 to 1 V, 0 to 5 V ratiometric, 0...10 V, 0...20 mA, 4...20 mA)
		J6-2	B7	universal analogue input 7 (NTC, 0 to 1 V, 0 to 5 V ratiometric, 0...10 V, 0...20 mA, 4...20 mA)
		J6-3	B8	universal analogue input 8 (NTC, 0 to 1 V, 0 to 5 V ratiometric, 0...10 V, 0...20 mA, 4...20 mA)
J6-4		GND	common for analogue inputs	
J7-1		ID9	digital input no. 9, 24 Vac/Vdc	
J7-2		ID10	digital input no. 10, 24 Vac/Vdc	
J7-3		ID11	digital input no. 11, 24 Vac/Vdc	
J7-4		ID12	digital input no. 12, 24 Vac/Vdc	
J7-5		IDC9	common for digital inputs from 9 to 12 (negative pole for DC power supply)	
J8-1		ID13H	digital input no. 13, 230 Vac	
J8-2		ID13	digital input no. 13, 24 Vac/Vdc	
J8-3		IDC13	common for digital inputs 13 and 14 (negative pole for DC power supply)	
J8-4		ID14	digital input no. 14, 24 Vac/Vdc	
J8-5		ID14H	digital input no. 14, 230 Vac	
S, M, L, XL		J9		8-pin telephone connector for connecting a display terminal (not used)
	J10		6-pin telephone connector for connecting the standard pGD1 user terminal	
	J11-1	RX-/TX-	RX-/TX- connector for RS485 connection to the pLAN network	
	J11-2	RX+/TX+	RX+/TX+ connector for RS485 connection to the pLAN network	
	J11-3	GND	GND connector for RS485 connection to the pLAN network	
	J12-1	C1	common for relays: 1, 2, 3	
	J12-2	NO1	normally open contact, relay no. 1	
	J12-3	NO2	normally open contact, relay no. 2	
	J12-4	NO3	normally open contact, relay no. 3	
	J12-5	C1	common for relays: 1, 2, 3	
	J13-1	C4	common for relays: 4, 5, 6	
	J13-2	NO4	normally open contact, relay no. 4	
	J13-3	NO5	normally open contact, relay no. 5	
	J13-4	NO6	normally open contact, relay no. 6	
	J13-5	C4	common for relays: 4, 5, 6	
	J14-1	C7	common for relay no. 7	
	J14-2	NO7	normally open contact, relay no. 7/ normally open contact, relay no. 7 SSR 24 Vac/Vdc (*)	
	J14-3	C7	common for relay no. 7	
	J15-1	NO8	normally open contact, relay no. 8/ only S-board: normally open contact, relay no. 8 SSR 24 Vac/Vdc, S board only (*)	
	J15-2	C8	common for relay no. 8	
J15-3	NC8/---	normally closed contact relay no. 8/ only S-board: not used, S board only (*)		
M, L, XL	J16-1	C9	common for relay: 9, 10, 11	
	J16-2	NO9	normally open contact, relay no. 9	
	J16-3	NO10	normally open contact, relay no. 10	
	J16-4	NO11	normally open contact, relay no. 11	
	J16-5	C9	common for relay: 9, 10, 11	
	J17-1	NO12	normally open contact, relay no. 12/ normally open contact, relay no. 12 SSR 24 Vac/Vdc (*)	
	J17-2	C12	common for relay no. 12	
	J17-3	NC12/---	normally closed contact relay no. 12/ not used (*)	
	J18-1	NO13	normally open contact, relay no. 13	
	J18-2	C13	common for relay no. 13	
J18-3	NC13	normally closed contact relay no. 13		
L	J19-1	ID15H	digital input no. 15, 230 Vac	
	J19-2	ID15	digital input no. 15, 24 Vac/Vdc	
	J19-3	IDC15	common for digital inputs 15 and 16 (negative pole for DC power supply)	
	J19-4	ID16	digital input no. 16, 24 Vac/Vdc	
	J19-5	ID16H	digital input no. 16, 230 Vac	
	J20-1	Y5	digital input no. 5 0...10 V	
	J20-2	Y6	digital input no. 6 0...10 V	
	J20-3	B9	passive analogue input 9 (NTC, PT1000, ON/OFF)	
	J20-4	BC9	common for analogue input 9	
	J20-5	B10	passive analogue input 10 (NTC, PT1000, ON/OFF)	

Version	Connector	Signal	Description
	J20-6	BC10	common for analogue input 10
	J20-7	ID17	digital input no. 17, 24 Vac/Vdc
	J20-8	ID18	digital input no. 18, 24 Vac/Vdc
	J20-9	IDC17	common for digital inputs 17 and 18 (negative pole for DC power supply)
	J21-1	NO14	normally open contact, relay no. 14/ normally open contact, relay no. 14 SSR 24 Vac/Vdc (*)
	J21-2	C14	common for relay no. 14
	J21-3	NC14/---	normally closed contact relay no. 14/ not used (*)
	J21-4	NO15	normally open contact, relay no. 15/ normally open contact, relay no. 15 SSR 24 Vac/Vdc (*)
	J21-5	C15	common for relay no. 15
	J21-6	NC15/---	normally closed contact relay no. 15/ not used (*)
	J22-1	C16	common for relay: no. 16, 17, 18
	J22-2	NO16	normally open contact, relay no. 16
	J22-3	NO17	normally open contact, relay no. 17
	J22-4	NO18	normally open contact, relay no.18
	J22-5	C16	common for relay: no. 16, 17, 18
	J23-1	E-	E- terminal for RS485 connection to the I/O expansion modules (not used)
	J23-2	E+	E+ terminal for RS485 connection to the I/O expansion modules (not used)
	J23-3	GND	GND terminal for RS485 connection to the I/O expansion modules (not used)
	J19-1	C21	common for relay: no. 21, 22, 23, 24
	J19-2	NO21	normally open contact, relay no. 21
	J19-3	NO22	normally open contact, relay no. 22
	J19-4	NO23	normally open contact, relay no. 23
	J19-5	NO24	normally open contact, relay no. 24
	J19-6	C21	common for relay: no. 21, 22, 23, 24
	J20-1	C25	common for relay: no. 25, 26, 27, 28, 29
	J20-2	NO25	normally open contact, relay no. 25
	J20-3	NO26	normally open contact, relay no. 26
	J20-4	NO27	normally open contact, relay no. 27
	J20-5	NO28	normally open contact, relay no. 28
	J20-6	NO29	normally open contact, relay no. 29
	J20-7	C25	common for relay: no. 25, 26, 27, 28, 29
	J21-1	C14	common for relay: no. 14, 15, 16
	J21-2	NO14	normally open contact, relay no. 14
	J21-3	NO15	normally open contact, relay no. 15
	J21-4	NO16	normally open contact, relay no. 16
	J21-5	C14	common for relay: no. 14, 15, 16
	J22-1	C17	common for relay: no. 17, 18, 19, 20
	J22-2	NO17	normally open contact, relay no. 17
	J22-3	NO18	normally open contact, relay no. 18
	J22-4	NO19	normally open contact, relay no. 19
	J22-5	NO20	normally open contact, relay no. 20
	J22-6	C17	common for relay: no. 17, 18, 19, 20
	J23-1	E-	terminal E- for RS485 connection to the I/O expansion modules (not used)
	J23-2	E+	terminal E+ for RS485 connection to the I/O expansion modules (not used)
	J23-3	GND	GND terminal for RS485 connection to the I/O expansion modules (not used)
	J24-1	+V term	additional power supply terminal Aria (not used)
	J24-2	GND	power supply common
	J24-3	+5 Vref	power supply for 0/5 V ratiometric probes

(*) depending on model

Tab. 2.k

2.2.2 Technical specifications of the pRack PR100 S, M, L, XL boards

Analogue inputs

Analogue conversion	10-bit A/D converter embedded in CPU		
Maximum number	pRack pR100 S	pRack pR100 M, XL	pRack pR100 L
	5	8	10
Type	<ul style="list-style-type: none"> • Universal: 6 (inputs B1, B2, B3, B6, B7, B8) CAREL NTC (-50T90°C; R/T 10 kΩ±1% at 25°C) or HT NTC (0T150°C) • Voltage: 0 to 1 Vdc, 0 to 5 Vdc ratiometric or 0 to 10 Vdc • Current: 0 to 20 mA or 4 to 20 mA. Input resistance: 100 Ω • Passive: 4 (inputs B4, B5, B9, B10) CAREL NTC (-50T90°C; R/T 10kΩ ±1% at 25°C), PT1000 (-100T200°C; R/T 1 kΩ to 0 °C) or digital input from voltage-free contact 		
	Selectable via software.		
Minimum normally-open voltage-free digital input detection time	Normally open (open-closed-open)	250 ms	
	Normally closed (closed-open-closed)	250 ms	
NTC input precision	± 0.5 °C		
PT1000 input precision	± 1 °C		
0-1 V input precision	± 3 mV		
0-10 V input precision	± 30 mV		
0-5 V input precision	± 15 mV		
0-20 mA input precision	± 0.06 mA		

Tab. 2.l

 **Important:** the 21 Vdc available at terminal +VDC (J2) can be used to power any active probes. The maximum current is 150 mA, thermally protected against short-circuits. To power the 0/5 V ratiometric probes use the 5 V available at terminal +5Vref (J24). The maximum current is 60 mA.

Digital inputs

Type	optically-isolated			
Maximum number		no. of 24 Vac 50/60 Hz or 24 Vdc optically-isolated inputs	no. of 24 Vac 50/60 Hz or 230 Vac 50/60 Hz optically-isolated inputs	Total
	pRack PR100 S	8	0	8
	pRack PR100 M, XL	12	2	14
	pRack PR100 L	14	2+2	18
Minimum digital input impulse detection time	Normally open (open-closed-open)		200 ms	
	Normally closed (closed-open-closed)		400 ms	
Power supply to the inputs	External	230 Vac o 24 Vac (50/60 Hz)	+10/-15 %	
		24 Vdc	+10/-20 %	
Classification of the measurement circuits (IEC EN 61010-1)	Category I 24 Vac/Vdc			
	Category III 230 Vac			

Tab. 2.m

Important:

- the 2 inputs, 230 Vac or 24 Vac/Vdc, present at terminals J8 (ID13, ID14) have the same common pole and therefore must be set to the same voltage (230 Vac or 24 Vac/Vdc). There is basic insulation between the 2 inputs. The same is true for J19 (ID15, ID16).
- in the event of direct current (24 Vdc), connect the negative pole to the common terminal.

Analogue outputs

Type	optically-isolated	
Maximum number	pRack PR100 S, M, XL	4 outputs (Y1-Y4) 0...10 Vdc
	pRack PR100 L	6 outputs (Y1-Y6) 0...10 Vdc
Power supply	external	
Precision	outputs Y1-Y4	± 2 % of full scale
	outputs Y5-Y6	-2/+5 % of full scale
Resolution	8 bit	
Settling time	outputs Y1-Y4	2 s
	outputs Y5-Y6	2 s o 15 s (selectable via software)
Maximum load	1 kΩ (10 mA)	

Tab. 2.n

Digital outputs

Important: the outputs can be divided into groups, depending on the insulation distance. The relays belonging to the same group have basic insulation between each other and therefore must have the same power supply (24 Vac or 230 Vac). Between groups there is double insulation and consequently these may have different voltages.

Models PRK100S*A*, PRK100M*A*, PRK100L*A*, PRK100Z*A* & PRK100S*B*, PRK100M*B*, PRK100L*B*, PRK100Z*B*

Makeup of the groups	Reference for relays with the same insulation/isolamento							
	Group 1	Group 2	Group 3	Group 4	Group 5	Group 6	Group 7	
	pRack PR100 S	1...7	8					
	Type of relay	Type A	Type A					
	pRack PR100 M	1...7	8	9...13				
	Type of relay	Type A	Type A	Type A				
	pRack PR100 L	1...7	8	9...13	14...18			
	Type of relay	Type A	Type A	Type A	Type A			
	pRack PR100 XL	1...7	8	9...13	14...16	17...20	21...24	25...29
	Type of relay	Type A	Type A	Type A	Type B	Type B	Type B	Type B
Number of changeover contacts	pRack PR100 S: none							
	pRack PR100 M, L, XL: 2 (outputs 8 & 13: J15 & J18)							
Switchable power	Relay Type A	Relay ratings	SPDT, 2000 VA, 250 Vac, 8 A resistive					
		Approval	UL873 EN 60730-1					
	Relay Type B	Relay ratings	SPDT, 1250 VA, 250 Vac, 5 A resistive					
		Approval	UL873 EN 60730-1					
Number of SSR outputs	pRack PR100 S: 2 (outputs 7 e 8); pRack PR100 M: 2 (outputs 7 e 12); pRack PR100 L, XL: 4 (outputs 7, 12, 14 e 15)							
SSR contact specifications	Operating voltage 24 Vac/Vdc Maximum power 10 W.							

Tab. 2.o

Models PRK100S*C*, PRK100M*C*, PRK100L*C*, PRK100Z*C* & PRK100S*D*, PRK100M*D*, PRK100L*D*, PRK100Z*D*

Makeup of the groups	References for relays with the same insulation							
	Group 1	Group 2	Group 3	Group 4	Group 5	Group 6	Group 7	
pRack PR100 S	1...7	8						
Type di Relay	Type A	Type A						
pRack PR100 M	1...7	8	9...13					
Type di Relay	Type A	Type A	Type A					
pRack PR100 L	1...7	8	9...13	14...18				
Type di Relay	Type A	Type A	Type A	Type A				
pRack PR100 XL	1...7	8	9...13	14...16	17...20	21...24	25...29	
Type di Relay	Type A	Type A	Type A	Type B	Type B	Type B	Type B	
Number of changeover contacts	pRack PR100 S: 1 (output 8: J15); pRack PR100 M, XL: 3 (outputs 8, 12 e 13: J15, J17, J18); pRack PR100 L: 5 (outputs 8, 12, 13, 14 e 15: J15, J17, J18, J21)							
Switchable power	Relay Type A	Relay ratings	SPDT, 2000 VA, 250 Vac, 8 A resistive					
		Approval	UL873	2.5 A resistive, 2 A FLA, 12 A LRA, 250 Vac, C300 pilot duty (30.000 cycles)				
	Relay Type B	Relay ratings	EN 60730-1	2 A resistive, 2 A inductive, $\cos\phi=0,6$, 2(2)A (100.000 cycles)				
		Approval	UL873	2.5 A resistive, 2 A FLA, 12 A LRA, 250 Vac, C300 pilot duty (30.000 cycles)				
Number of SSR outputs	nessuna							

Tab. 2.p

Important: the groups that the digital outputs are divided into have two common pole terminals to Simplify wiring. Make sure that the current running through the common terminals does not exceed the rated current of an individual terminal, that is, 8 A. To connect the digital outputs use a cable with minimum cross-section of 1.5 mm².

Important: the following rules must be observed for the SSR digital outputs, otherwise they may be damaged:

- control only resistive loads with a maximum power of 10 W;
- to control inductive loads, use an external relay;
- to power resistive loads or the external relay use the same power supply as pRack Compact (terminals G-G0) that must be dedicated and not common with other devices (in the case of external SSRs the voltage supplied by pRack to the +Vdc terminal can be used, after having checked the maximum current draw of the active probes and the SSRs).

See paragraph 3.6.2 for the connection diagrams.

2.2.3 Electrical specifications of the pRack PR100 S, M, L, XL boards

Power supply	24 Vac +10/-15 % 50/60 Hz e 28...36 Vdc +10/-20 %, at least 50 VA for each board		
Maximum current with terminal connected	40 VA (Vac) /15 W (Vdc)		
Type of insulation of power supply from the rest of the controller	-		
Terminal block	with male/female plug-in connectors (250 Vac max, 8 A max)		
Cable cross-section	min 0.5 mm ² - max 2.5 mm ²		
CPU	H8S2320, 16 bit, 24 MHz		
Program memory (FLASH)	2+2MByte (Dual Bank) at 16 bit		
Data memory (RAM)	512 Kbyte at 16 bit		
Parameter data memory (EEPROM)	13 Kbyte + 32KByte		
Working cycle duration	0.2 s (application of average complexity)		
Clock with battery	Available as standard		

Tab. 2.q

2.2.4 Mechanical specifications of the pRack PR100 S, M, L, XL boards

Physical dimensions:	pRack PR100 S	13 DIN modules	110x227.5x60 mm
	pRack PR100 M, L, XL	18 DIN modules	110x315x60 mm

Plastic case:	
Assembly	Fitted on DIN rail as per DIN 43880 and IEC EN 50022
Material	Technopolymer
Flame retardance	V0 (UL94) and 960 °C (IEC 695)
Ball pressure test	125 °C
Resistance to creeping current	≥250 V
Colour	Grey RAL7016

Tab. 2.r

2.2.5 Other specifications of the pRack PR100 S, M, L, XL boards

Operating conditions	-25T70°C, 90 % RH non-condensing	
Storage conditions	-40T70°C, 90 % RH non-condensing	
Index of protection	IP20, IP40 on the front panel only	
Environmental pollution	2	
Class according to protection against electric shock	to be integrated into Class 1 and/or 2 appliances	
PTI of the insulating materials	250 V	
Period of stress across the insulating parts	Long	
Type of action	1C	
Type of disconnection or microswitching	microswitching, for all relay outputs	
Category of Resistance to heat and fire	Category D	
Immunity against voltage surges	Category I	
Ageing characteristics (operating hours)	80.000	
No. of automatic operating cycles	100.000 (EN 60730-1); 30.000 (UL 873)	
Software class and structure	Class A	
Category of immunity to voltage surges (IEC EN 61000-4-5)	Category III	
Clock	Error at 25°C	±5.3 min/year
	Error in the temperature range -10T60 °C	±27 min/year
	Ageing	< ± 5ppm (±2.7min/year)
	Battery duration	typically 6 months (8 months maximum)
	Recharge time	typically 5 hours (< 8 hours maximum)

Tab. 2.s

2.2.6 pRack PR100 S board dimensions

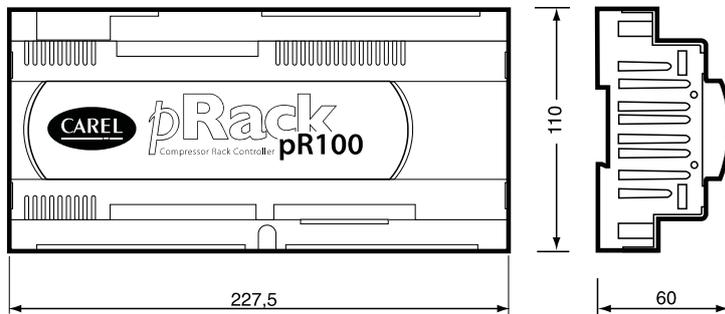

Fig. 2.g

2.2.7 pRack PR100 M, L, XL board dimensions

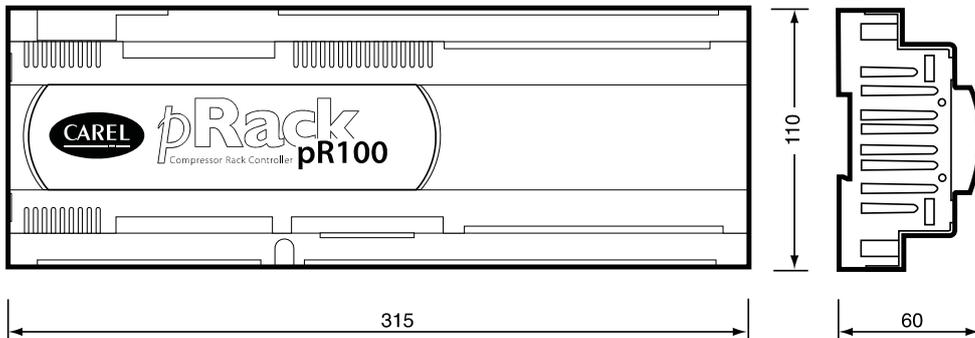

Fig. 2.h

2.2.8 pRack PR100 S, M, L, XL product certification

- IEC EN 50155: "Railway applications – Electronic equipment used on rolling stock";
- UL 873 and C22.2 No. 24-93: "Temperature-indicating and regulating equipment";
- CE directives (LVD/EMC).

 **Note:** for further details on the pRack boards, see the pCO Sistema manual, code +030220335.

2.3 pRACK pR100 board general connection diagram

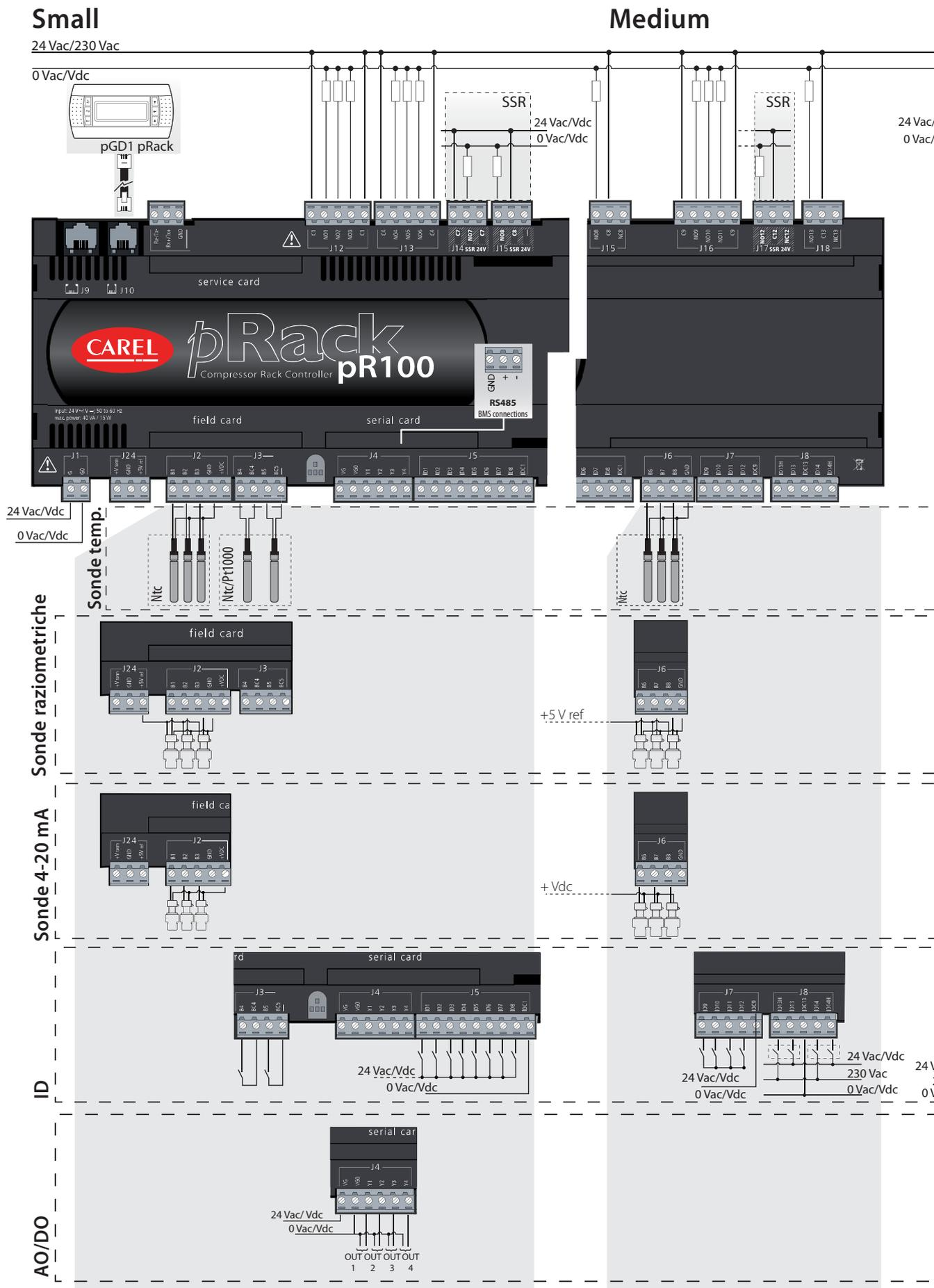
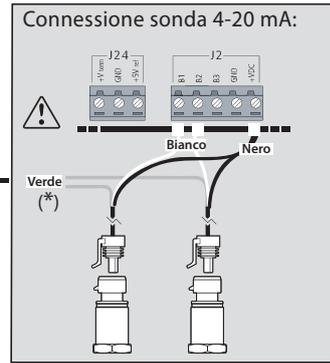
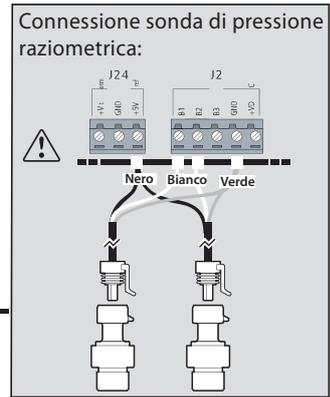
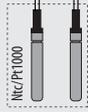
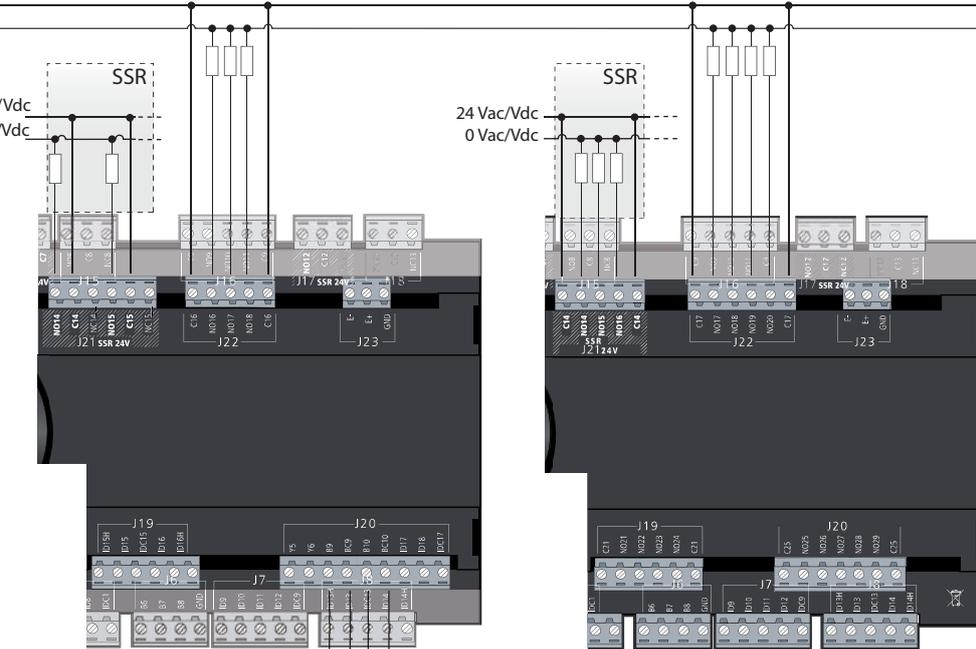

Fig. 2.i

Large

ExtraLarge



(*) NOT USED
For other kind of 4-20mA sensors check the relative technical leaflets

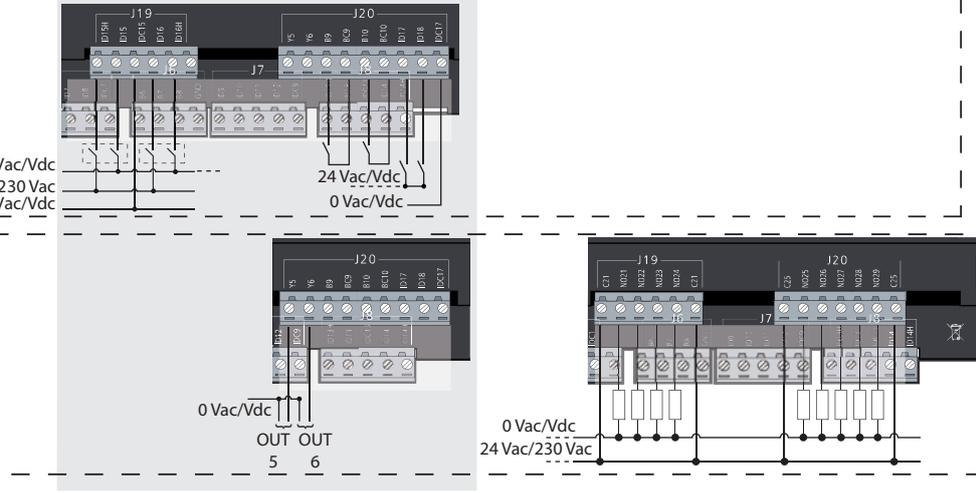

3. INSTALLATION

3.1 General installation instructions

3.1.1 Installation procedure

Environmental conditions

Avoid assembling the pRack PR100 and the terminal in environments with the following characteristics:

- temperature and humidity that do not conform to the rated operating data of the product;
- strong vibrations or knocks;
- exposure to aggressive and polluting atmospheres (e.g.: sulphur and ammonia fumes, saline mist, smoke) so as to avoid corrosion and/or oxidation;
- strong magnetic and/or radio frequency interference (therefore avoid installing the units near transmitting antennae);
- exposure of the pRack PR100 to direct sunlight and to the elements in general;
- large and rapid fluctuations in the room temperature;
- environments containing explosives or mixes of flammable gases;
- exposure to dust (formation of corrosive patina with possible oxidation and reduction of insulation).

Positioning the instrument inside the panel

The position of the instrument in the electrical cabinet must be chosen so as to guarantee correct physical separation of the instrument from the power components (solenoids, contactors, actuators, inverters, ...) and the connected cables. Proximity to such devices/cables may create random malfunctions that are not immediately evident.

The structure of the panel must allow the correct flow of cooling air.

3.1.2 Wiring procedure

When laying the wiring, "physically" separate the power part from the control part. The proximity of these two sets of wires will, in most cases, cause problems of induced disturbance or, over time, malfunctions or damage to the components. The ideal solution is to house these two circuits in two separate cabinets. Sometimes this is not possible, and therefore the power part and the control part must be installed inside the same panel. For the control Signals, it is recommended to use shielded cables with twisted wires.

If the control cables have to cross over the power cables, the intersections must be as near as possible to 90 degrees, always avoiding running the control cables parallel to the power cables.

- Use cable ends suitable for the corresponding terminals. Loosen each screw and insert the cable ends, then tighten the screws. When the operation is completed, slightly tug the cables to check they are sufficiently tight;
- separate as much as possible the sensor Signal, digital input and serial line cables from the cables carrying inductive loads and power cables to avoid possible electromagnetic disturbance. Never insert power cables (including the electrical cables) and probe Signal cables in the same conduits. Do not install the sensor cables in the immediate vicinity of power devices (contactors, circuit breakers or similar);
- reduce the path of the sensor cables as much as possible, and avoid spiral paths that enclose power devices;
- avoid touching or nearly touching the electronic components fitted on the boards to avoid electrostatic discharges (extremely damaging) from the operator to the components;
- if the power transformer secondary is earthed, check that the earth wire corresponds to the wire that runs to the controller and enters terminal G0; this applies to all the devices connected to the pRack PR100;
- do not secure the cables to the terminals by pressing the screwdriver with excessive force, to avoid damaging the pRack PR100;
- for applications subject to considerable vibrations (1.5 mm pk-pk 10/55 Hz), secure the cables connected to the pRack PR100 around 3 cm from the connectors using clamps;
- if the product is installed in industrial environments (application of the EN 61000-6-2 standard) the length of the connections must be less than 30 m;

- all the very low voltage connections (analogue and 24 Vac/Vdc digital inputs, analogue outputs, serial bus connections, power supplies) must have reinforced or double insulation from the mains network;
- in residential environments, the connection cable between the pRack PR100 and the terminal must be shielded;
- there is no limit to the number of cables that can be connected to an individual terminal. The only limitation concerns the maximum current crossing each terminal: this must not exceed 8 A;
- the maximum cross-section of the cable that connected to a terminal is 2.5 mm² (12 AWG);
- the maximum value of the twisting torque to tighten the screw on the terminal (torque tightening) is 0.6 Nm;



- Important:**
- Installation must be performed according to the standards and legislation in force in the country where the device is used;
 - for safety reasons the equipment must be housed inside an electrical panel, so that the only accessible part is the display and the keypad;
 - in the event of malfunctions, do not attempt to repair the device, but rather contact the CAREL service centre;
 - the connector kit also contains the stick-on labels.

3.1.3 Anchoring the pRack PR100

The pRack PR100 is installed on a DIN rail. To fasten the unit to the DIN rail, press it lightly against the rail. The rear tabs will click into place, locking the unit to the rail. Removing the unit is just as Simple, using a screwdriver through the release slot to lever and lift the tabs. The tabs are kept in the locked position by springs.

3.2 Power supply

Power supply to the pRack PR100 S, M, L, XL (controller with terminal connected)	28...36 Vdc +10/-20% or 24 Vac +10/-15% 50...60 Hz; Maximum current P= 15 W (power supply Vdc). P=40 VA (Vac)
Power supply to the pRack PR100 Compact	DC power supply: 48 Vdc (36 Vmin...72 Vmax) AC power supply: 24 Vac +10/-15 %, 50/60 Hz Maximum current P=11W, P=14VA, I _{max} =700mA

Tab. 3.a



- Important:**
- power supplies other than those specified seriously damage the system;
 - a Class II safety transformer, must be used in the installation to supply just one pRack PR100 controller, rating 30 VA for pRack Compact and 50 VA for pRack S, M, L, XL ;
 - the power supply to the pRack PR100 controller and terminal (or pRack PR100 controllers and terminals) should be separated from the power supply to the other electrical devices (contactors and other electromechanical components) inside the electrical panel;
 - if the power transformer secondary is earthed, check that the earth wire corresponds to the wire that runs to the controller and enters terminal G0. This applies to all the devices connected to the pRack PR100;
 - a yellow LED indicates that power is connected to the pRack PR100.

3.3 Connecting the analogue inputs

The analogue inputs on the pRack PR100 can be configured for the most common sensors on the market: 0 to 1 V, 0...10 V, 0...20 mA, 4...20 mA. The different types of sensors for each input can be selected by setting a parameter on the user terminal.

3.3.1 Connecting universal NTC temperature sensors

The analogue inputs are compatible with 2-wire NTC sensors. The inputs must be set for NTC Signals from the user terminal or using the default value installation procedure. The connection diagram is shown below:

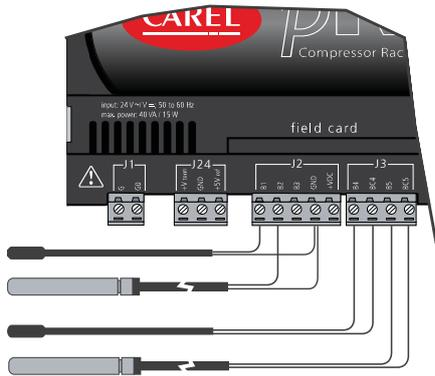

Fig. 3.a

Hardware Version	Terminals	NTC probe cable
Compact	GND	1
	B1, B2, B3, B4, B5, B6, B7, B8	2
S	GND, BC4, BC5	1
	B1, B2, B3, B4, B5	2
M, XL	GND, BC4, BC5	1
	B1, B2, B3, B4, B5, B6, B7, B8	2
L	GND, BC4, BC5, BC9, BC10	1
	B1, B2, B3, B4, B5, B6, B7, B8, B9, B10	2

Tab. 3.b

Note: the two wires of the NTC sensors are equivalent, as they have no polarity, therefore it is not necessary to follow any specific order when connecting to the terminal block.

3.3.2 Connecting PT1000 temperature sensors

The pRack PR100 can be connected to 2-wire PT1000 sensors for all high temperature applications; the operating range is: -100 to 200 °C. The inputs must be pre-configured for PT1000 Signals from the user terminal or using the default value installation procedure. The connection diagram is shown below:

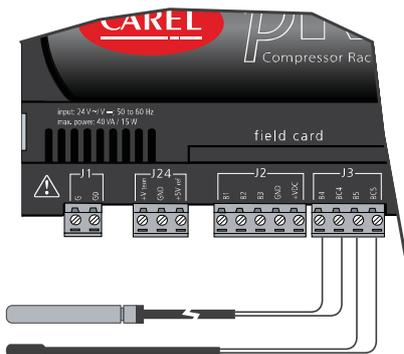

Fig. 3.b

Hardware Version	Terminals	PT1000 probe cable
Compact	GND	1
	B3, B4	2
S, M, XL	BC4, BC5	1
	B4, B5	2
L	BC4, BC5, BC9, BC10	1
	B4, B5, B9, B10	2

Tab. 3.c

Important: for correct measurement by the PT1000 sensor, each sensor wire needs to be connected to a dedicated terminal, as shown in Fig. 3.b.

Note: the two wires of the PT1000 sensors are equivalent, as they have no polarity, therefore it is not necessary to follow any specific order when connecting to the terminal block.

3.3.3 Connecting current pressure probes

pRack PR100 can be connected to all CAREL SPK* series active pressure probes or any other pressure sensors available on the market with 0...20 mA or 4...20 mA Signal.

The inputs must be set for 0...20 mA or 4...20 mA Signals from the user terminal or using the default value installation procedure. The connection diagram is shown below:

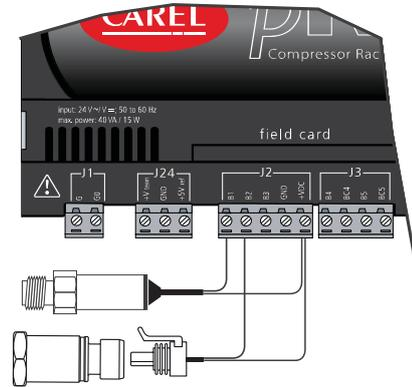

Fig. 3.c

Hardware Version	Terminals	Probe wire colour	Description
Compact	+VDC	brown	power supply
	B1, B2, B5, B6	white	Signal
S, M, L, XL	+VDC	brown	power supply
	B1, B2, B3, B6, B7, B8	white	Signal

Tab. 3.d

Important: do not connect the green wire.

3.3.4 Connecting 0 to 5 V ratiometric pressure probes

pRack PR100 can be connected to any other pressure probes available on the market with 0 to 5 V ratiometric sensor.

The inputs must be set for 0 to 5 V Signals from the user terminal or using the default value installation procedure. The connection diagram is shown below:

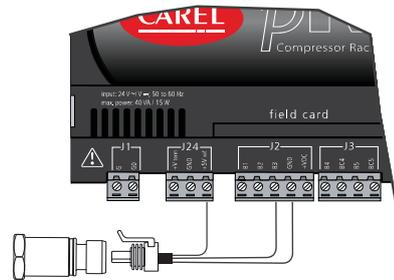

Fig. 3.d

Hardware Version	Terminals	Probe wire colour	Description
Compact	+5Vref	black	power supply
	GND	green	power supply reference
	B1, B2, B5, B6	white	Signal
S, M, L, XL	+5 Vref	black	power supply
	GND	green	power supply reference
	B1, B2, B3, B6, B7, B8	white	Signal

Tab. 3.e

3.3.5 Connecting 0...10 V active probes

pRack PR100 can be connected to 0...10 V sensors. The inputs must be set for 0...10 V Signals from the user terminal or using the default value installation procedure. The connection diagram is shown below:

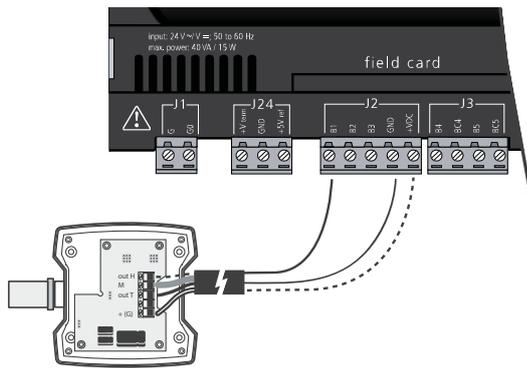

Fig. 3.e

Hardware Version	Terminals	Description
Compact	+VDC	power supply (any)
	GND	reference
	B1, B2, B5, B6	Signal
S, M, L, XL	+VDC	power supply (any)
	GND	reference
	B1, B2, B3, B6, B7, B8	Signal

Tab. 3.f

3.3.6 Connecting the analogue inputs selected as ON/OFF

The pRack PR100 allows some analogue inputs to be configured as voltage-free digital inputs, not optically-isolated. The inputs must be pre-configured as voltage-free digital inputs from the user terminal or using the default value installation procedure.

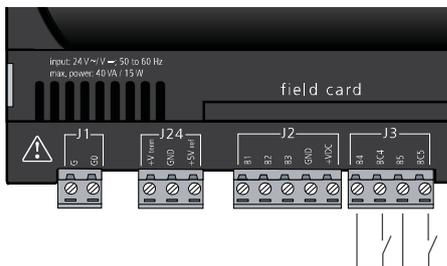

Fig. 3.f

Hardware Version	Terminals	Digital input cable
Compact	GND	1
	B5, B9	2
S, M, XL	BC4, BC5	1
	B4, B5	2
S, M, L, XL	BC4, BC5, BC9, BC10	1
	B4, B5, B9, B10	2

Tab. 3.g

Important: the maximum current available at the digital input is 5 mA (thus the rating of the external contact must be at least 5 mA).

Important: these inputs are not optically-isolated.

3.3.7 Remote connection of the analogue inputs

The Sizes of the cables for the remote connection of the analogue inputs are shown in the following table:

Type of input	Size [mm ²] for length up to 50 m	Size [mm ²] for length up to 100 m
NTC	0.5	1.0
PT1000	0.75	1.5
current	0.25	0.5
voltage	0.25	0.5

Tab. 3.h

3.4 Connecting the digital inputs

The pRack PR100 features digital inputs for connecting safety devices, alarms, device status and remote switches. These inputs are all optically isolated from the other terminals. They can work at 24 Vac, 24 Vdc and some at 230 Vac.

Note: separate the sensor Signal and digital input cables as much as possible from the inductive load and power cables, to avoid possible electromagnetic disturbance.

Important:

- if the control voltage is drawn in parallel with a coil, fit a dedicated RC filter in parallel with the coil (the typical ratings are 100 Ω, 0.5 μF, 630 V).
- If connecting the digital inputs to safety systems (alarms), remember that: the presence of voltage across the contact must be the normal operating condition, while no voltage must represent an alarm situation. This will ensure that any interruption (or disconnection) of the input will also be Signalled. Do not connect the neutral in place of an open digital input. Always interrupt the phase. The 24 Vac/Vdc digital inputs have a Resistance of around 5 kΩ.

3.4.1 Connecting the digital inputs

Connecting the pRack Compact digital inputs

The digital inputs on the pRack PR100 Compact are voltage-free contacts. The following figure shows a connection example.

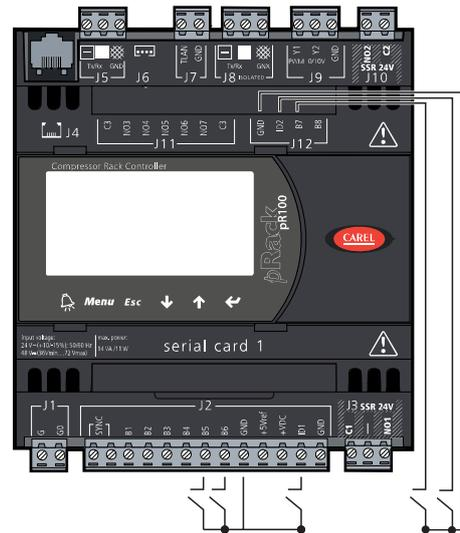

Fig. 3.g

Connecting the digital inputs: S, M, L, XL models

All pRack digital inputs can be powered at 24 Vac and 24 Vdc, while for models M, L and XL only 230 Vac inputs are also available.

To maintain the optical isolation of the digital inputs, a separate power supply must be used just for the digital inputs.

The connection diagrams shown in these figures, which while being the more common and the more convenient, do not exclude the possibility of powering the digital inputs independently from the power supply to the pRack PR100.

In any case, the inputs only have functional insulation from the rest of the controller.

24 Vac digital inputs.

The following figure represents an example for connecting the 24 Vac digital inputs on pRack models S, M, L XL.

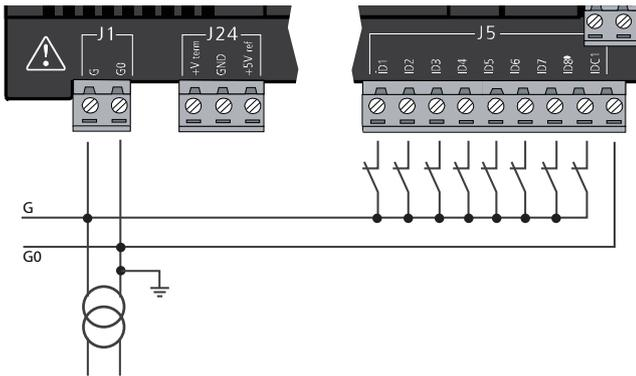

Fig. 3.h

24 Vdc digital inputs

The following figure represents an example for connecting the 24 Vdc digital inputs on pRack models S, M, L XL.

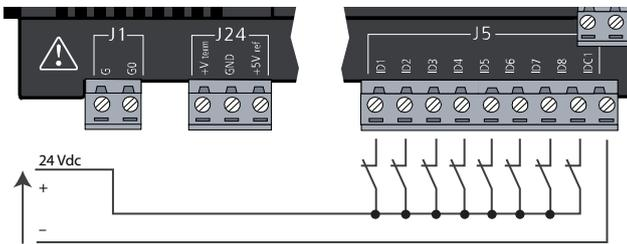

Fig. 3.i

230 Vac digital inputs.

pRack M, L, XL models have up to two groups of inputs powered at 230 Vac 50/60 Hz +10/-15%; each group features two inputs (see paragraph 2.2.1 for details). The groups have double insulation between them and can have different voltages.

⚠ Important: within each group the inputs must be powered at the same voltage to avoid short-circuits or powering lower voltage inputs at 230 Vac.

The range of uncertainty of the switching threshold is from 43 to 90 Vac. It is recommended to use a 100 mA fuse in series with the digital inputs.

The following figure represents an example for connecting the 230 Vac digital inputs on pRack models S, M, L XL.

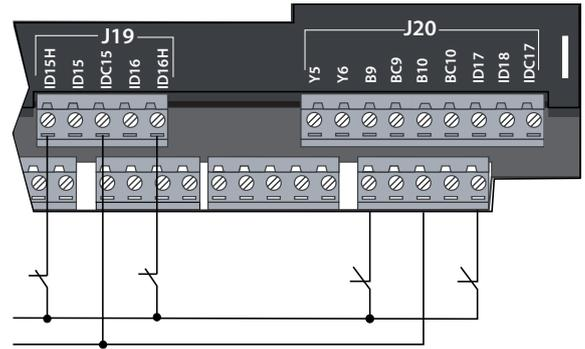

Fig. 3.j

3.4.2 Remote connection of the digital inputs

⚠ Important note: do not connect other devices to the digital inputs IDn inputs.

The Sizes of the cables for the remote connection of the digital inputs are shown in the following table:

Size (mm ²) for length up to 50 m	Size (mm ²) for length until 100 m
0,25	0,5

If the product is installed in industrial environments (application of the EN 61000-6-2 standard) the length of the connections must be less than 30 m. This length shouldn't be exceeded in any case, to avoid measurement errors.

3.5 Connecting the analogue outputs

3.5.1 Connecting 0...10 V analogue outputs

The pRack PR100 provides 0...10 V optically-isolated analogue outputs, powered externally at 24 Vac/Vdc.

The figure below shows the electrical connection diagram; the 0V (zero) of the power supply is also the reference for the output voltage:

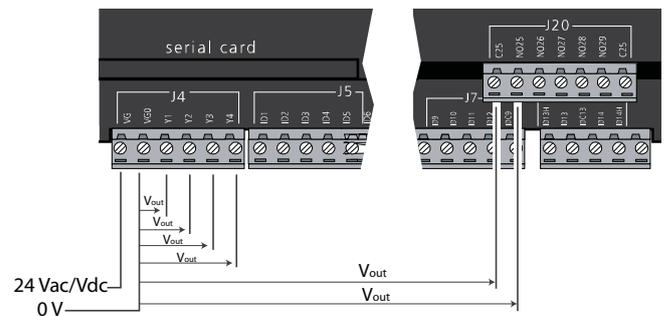

Fig. 3.k

Hardware Version	Terminals	Reference
Compact	Y2	G0
S, M, XL	Y1, Y2, Y3, Y4	VG0
L	Y1, Y2, Y3, Y4, Y5, Y6	VG0

Tab. 3.i

3.5.2 Connecting PWM analogue outputs

The pRack PR100 Compact Version provides a PWM analogue output (5 V pulses) for phase cutting speed controllers or for connecting the CONV0/10A0 or CONVONOFF modules (see following paragraph), based on the setting from the user terminal or using the default value installation procedure. The following figure shows a connection example:

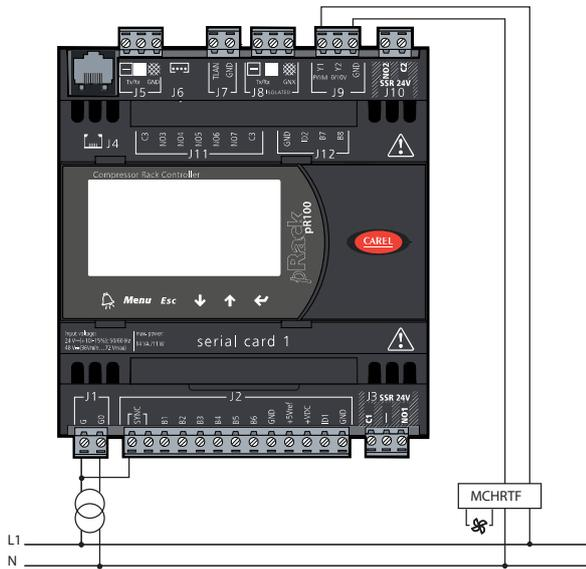

Fig. 3.l

Hardware Version	Terminals	Reference
Compact	Y1	G0
S, M, L, XL	Not available	

Tab. 3.j

Note: the power supply to the circuit measuring the zero crossing is at terminal SYNC on the pRack PR100 Compact and must be 24 Vac, in phase with the power supply to the actuator: for three-phase power supply, use the same phase to power the pRack PR100 Compact and the actuator.

3.5.3 Optional modules

Module for converting a PWM analogue output to a liner 0...10 V and 4...20 mA analogue output (code CONV0/10A0)

The module is used to convert a PWM output (5 V pulses) to a liner 0...10 V and 4...20 mA analogue output (code CONV0/10A0).

The control Signal (at the input terminals optically-isolated from the rest of the module) must have a maximum amplitude of 5V and a period between 8 ms and 200 ms. The 0...10V output voltage can be connected to a maximum load of 2 kΩ, with a maximum ripple of 100 mV.

The 4...20 mA current output can be connected to a maximum load of 280 Ω, with maximum overshoot of 0.3 mA.

The mechanical dimensions of the module are 87x36x60 mm (2 DIN modules) with IP20 index of protection.

Module for converting a 0...10 V analogue output to an SPDT digital output (code CONVONOFF0)

The module is used to convert a 0...10 V analogue output to an ON/OFF relay output. The control Signal (at the input terminals, optically-isolated from the rest of the module), to ensure the switching of the relay from OFF to ON, must have a maximum amplitude of 3.3 V. The relay is SPDT, with max current of 10 A and max inductive load of 1/3 HP. The mechanical dimensions of the module are 87x36x60 mm (2 DIN modules) with IP20 index of protection.

3.6 Connecting the digital outputs

3.6.1 Electromechanical relay digital outputs

The pRack PR100 features digital outputs with electromechanical relays. For ease of installation, the common terminals of some of the relays have been grouped together.

The following figure illustrates a connection example. If the following this diagram is used, the current at the common terminals must not exceed the rating (nominal current) of a single terminal (8 A).

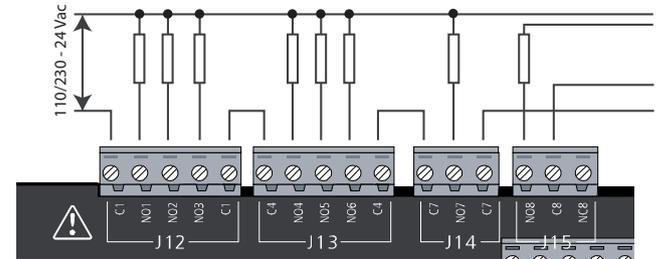

Fig. 3.m

The relays are divided into groups, according to the degree of insulation. Inside each group, the relays have just basic insulation and thus must have the same voltage (generally 24V ac or 110 to 230 Vac).

Between the groups there is double insulation and thus the groups can have different voltages. There is also double insulation from the rest of the controller.

Changeover outputs

Some relays feature changeover outputs, the number of changeover outputs depends on whether or not there are solid state relays (SSR) and consequently varies depending on the models.

Hardware Version	Changeover relay reference, without SSR model	Terminal
PRK100**A* and PRK100**B* models		
Compact	1	J3
S	8	J15
M, XL	8, 12, 13	J15, J17, J18
L	8, 12, 13, 14, 15	J15, J17, J18, J21
PRK100**C* and PRK100**D* models		
Compact, S	-	-
M, L, XL	8, 13	J15, J18

Tab. 3.k

3.6.2 Solid state relay (SSR) digital outputs

The pRack PR100 also features a Version with solid state relays (SSR) on some models for controlling devices that require an unlimited number of switching cycles and thus would not be supported by electromechanical relays (e.g. screw compressor valves). They are dedicated to loads powered at 24 Vac/Vdc with a maximum power Pmax = 10 W.

Important: the SSRs can control resistive loads powered at 24 Vac/Vdc, maximum power Pmax= 10 W. For details see paragraph 2.2.2. The figure shows a connection example for resistive loads.

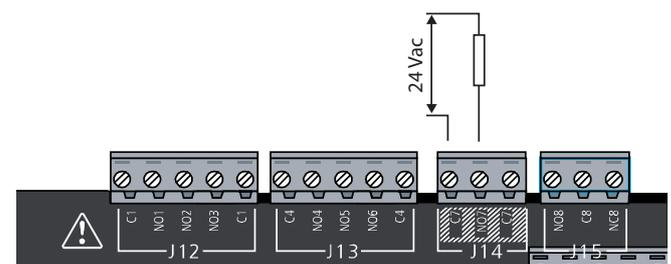

Fig. 3.n

The following figure illustrates correct applications for inductive loads.

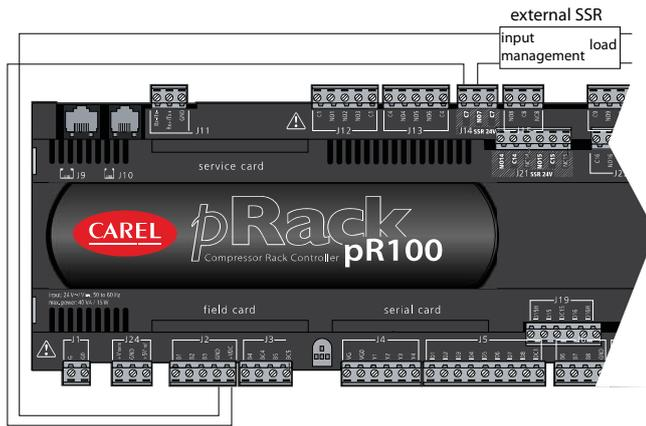

Fig. 3.o

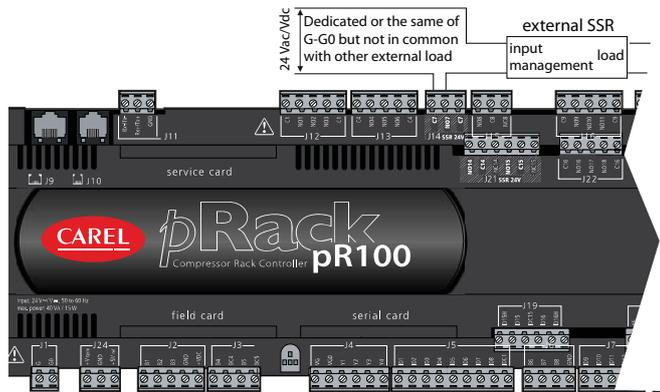

Fig. 3.p

The table below shows the reference outputs for pRack models fitted with SSR outputs.

Hardware Version	Reference Relay SSR	Terminal
Compact	1, 2	J3
S	7, 8	J14, J15
M	7, 12	J14, J15
L, XL	7, 12, 14, 15	J14, J15, J21

Tab. 3.l

Important: the SSR relay load is powered at 24 Vac/Vdc, thus all the other terminals in the group must be powered at 24 Vac/Vdc due to the absence of double insulation within the group. Moreover, the other terminals of the group can be powered at 110-230 Vac using a safety transformer (Class 2).

3.6.3 Summary table of digital outputs according to the Versions available

Hardware Version	NO contacts	NC contacts	changeover contacts	total no. of outputs	SSR relays
Models PRK100**A* and PRK100**B*					
Compact	5	-	-	7	2 (1, 2)
S	6	-	-	8	2 (7, 8)
M	9	-	2 (8, 13)	13	2 (7, 12)
L	12	-	2 (8, 13)	18	4 (7, 12, 14, 15)
XL	23	-	2 (8, 13)	29	4 (7, 12, 14, 15)
Models PRK100**C* and PRK100**D*					
Compact	6	-	1 (1)	7	-
S	7	-	1 (8)	8	-
M	10	-	3 (8, 12, 13)	13	-
L	13	-	5 (8, 12, 13, 14, 15)	18	-
XL	26	-	3 (8, 12, 13)	29	-

Tab. 3.m

3.6.4 Remote connection of the digital outputs

The Sizes of the cables for the remote connection of the digital outputs are shown in the following table:

AWG	Size [mm ²]	Current [A]
20	0,5	2 A
15	1,5	6 A
14	2,5	8 A

Tab. 3.n

If the product is installed in industrial environments (application of the EN 61000-6-2 standard) the length of the connections must be less than 30 m. This length shouldn't be exceeded in any case, to avoid measurement errors.

3.7 pLAN electrical connections

If the selected system configuration involves the connection of more than one pRack PR100 board in a pLAN, AWG20/22 twisted pair shielded cable must be used, with capacitance between the wires less than 90 PF/m. The maximum length of the pLAN network is 500 m with AWG22 twisted pair shielded cable. The boards should be connected in parallel with reference to plug-in connector J5 (pRack Compact) or J11 (Versions S, M, L, XL).

Important: follow the network polarity: RX/TX+ on one board must be connected to RX/TX+ on the other boards; the same applies to RX/TX-.

The figure shows the diagram for more than one board connected in a pLAN network powered by the same transformer; this is a typical application with more than one board connected inside the same electrical panel.

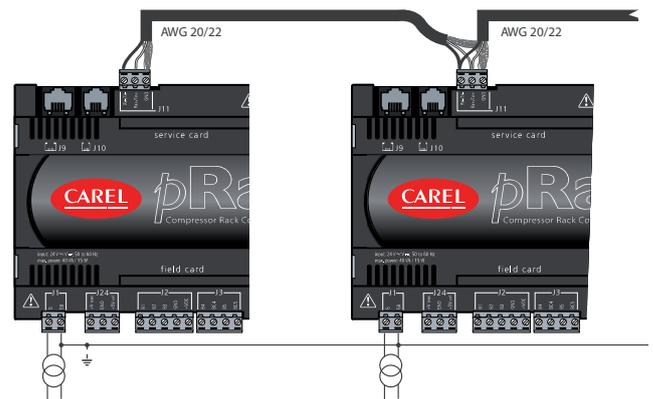

Fig. 3.q

Important: pLAN connections are also possible with multiple boards powered by different transformers, for further details see the pCO Sistema manual, code: +030220335.

3.7.1 Connecting the terminals

pRack PR100 features PGD1 terminals, both built-in and external connected via pLAN. Up to two external terminals can be connected, with pLAN addresses 31 and 32.

The connection can be made using 6-wire telephone cables (connector J4 for Compact models or J10 for S, M, L, XL models) or shielded pair cables with 3-pin plug-in connectors (connector J5 for models Compact or J11 for S, M, L, XL models), as shown in the table:

Type of cable	Power supply distance	Power supply
6-wire telephone (J10)	10 m	Taken from pRack (150 mA)
AWG24	200 m	Taken from pRack (150 mA)
AWG20/22	500 m	Separate, from TCONN6J000

Tab. 3.o

For further details on connecting the terminals see the pCO sistema manual, code: +030220335.

4. START UP

4.1 Starting the first time

After having correctly installed pRack, a number of preliminary operations are required to configure the installation.

Tutorial: the pRack PR100 configuration procedure varies according to the complexity of the installation:

- A. **systems with only one board and maximum one external terminal.** In this case, simply connect the terminal (if not built-in), power up the board and select one of the configuration solutions described below.
- B. **systems with more than one board in pLAN or two external terminals.** In this case, the additional operations described in Appendix A. 2 need to be completed before proceeding with configuration.

The procedure for configuring an installation described below is the same for all system configurations that feature just one pRack PR100 board, and for system configurations with more than one board connected in a pLAN.

When first starting the pRack PR100 board, after waiting around 1 minute, a screen is shown for choosing the language used to display the program (English or Italian).

Press ENTER (↵) to change the language displayed, while pressing ESC displays the following screen.

Note: If no option is chosen within a time set by parameter and visible on the screen, the current language remains selected.

Note: pRack PR100 is available as standard with English and Italian languages loaded on board. Other languages are available at ksa.carel.com that can be loaded onto the control using the pRack Manager software, following the procedure described in Chap. 10.

After having selected the user interface language, the pRack PR100 software shows a screen for choosing between three possible system configuration solutions, as follows:

- Pre-configurations
- Wizard
- Advanced configuration.

Important: after having configured the system, the configuration can be modified, it can be modified by repeating the same procedure, making sure the Carel default values have been reset as described in paragraph 6.8.2.

Important: after having configured the system, power down the controller and power up again.

Summary of pre-configurations

N°	index	lines	compressors				fans	Units in the pLAN(as well as the terminal)	pRack PR100 Version		
			type	N°	capacity	step modulation					
1	RS2	1	Piston - Scroll	2	-	-	1	2	-	1	Compact
2	RS3	1	Piston - Scroll	3	-	-	1	3	-	1	Small
3	RS3p	1	Piston - Scroll	3	1	-	2	1	Inverter	1	Medium
4	RS3i	1	Piston - Scroll	3	-	Inverter	3	1	Inverter	1	Medium
5	RS4	1	Piston - Scroll	4	-	-	2	4	-	1	Medium
6	RS4i	1	Piston - Scroll	4	-	Inverter	3	1	Inverter	1	Large
7	SL3d	1	Scroll	3	-	Digital	1	2	-	1	Medium
8	SL5d	1	Scroll	5	-	Digital	1	1	Inverter	1	Medium
9	SW1	1	Screw	1	2	-	2	2	-	1	Small
10	SW2	1	Vite	2	2	-	2	1	Inverter	1	Small
11	d-RS2	2	Pistoni - Scroll	2	-	-	1	2	-	1	Medium
				2	-	-	1				
12	d-RS3	2	Pistoni - Scroll	3	-	-	1	3	-	1	Large
				3	-	-	1	3	-		
13	d-RS4	2	Pistoni - Scroll	4	-	Inverter	3	1	Inverter	1,2	Medium + Medium
				4	-	Inverter	3	1	Inverter		

(*) configuration not available in versions 1.0 and 1.1 of the pRack software.

4.1.1 Pre-configurations

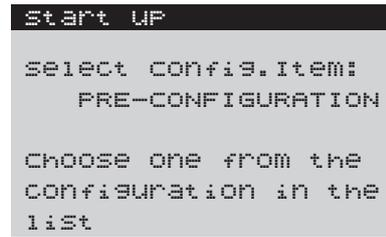

Fig. 4.a

This solution is used to choose between fourteen configurations pre-loaded in the pRack PR100 software. For the description of the pre-configurations see the table below, while for the complete description of each configuration see Appendix A1.

pRack PR100 automatically configures the inputs and outputs as described in paragraph 4.1.4; for details on the inputs and outputs associated with each pre-configuration, see the quick guide code +040000070.

4.1.2 Wizard

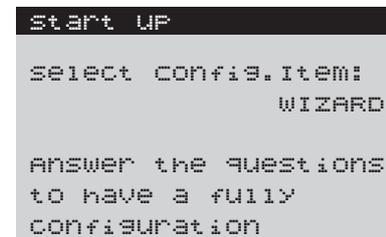

Fig. 4.b

This solution is used to obtain the recommended configuration for the specific installation. By responding to a series of questions, screen by screen, the user is guided through the selection of the devices present.

Once the guided selection procedure has been completed, the end result (report) is shown, and if the configuration is suitable the parameters to start operation of the pRack PR100 can be installed directly, including those associated with the inputs and outputs as described in parag. 4.1.4.

Note: after having configured the parameters using the Wizard, the configuration can be modified manually, within the context of the selected system configuration.

Important: before starting the pRack PR100, carefully check the settings made automatically by the software.

Tutorial: Appendix A.3 shows a configuration example using the Wizard for an installation with two suction lines.

4.1.3 Advanced configuration

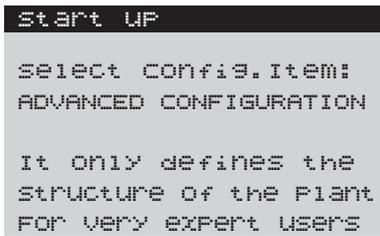

Fig. 4.c

This solution is used to establish the configuration of the pLAN structure required for correct system operation.

Once the procedure for selecting the various factors that affect the final configuration has been completed, the pRack PR100 software verifies whether the pLAN configuration is exact and prepares the user interface for configuration of the parameters that need to be set manually by the user.

⚠ Important: this configuration solution is only recommended for expert users, as all the system parameters need to be set manually.

4.1.4 Associating the inputs and outputs

When using pre-configurations and the wizard, pRack pR100 can automatically associate the board's inputs and outputs with the various functions.

For the wizard only, after having configured the lines, automatic association can be chosen as an option. If choosing not to use this function, the I/Os need to be configured manually, according to requirements.

The criteria applied for automatic association are described below.

Digital outputs

pRack PR100 assigns in order:

- Compressor outputs: first the SSR outputs for screw or Digital Scroll™ then the starting outputs, the capacity control valves and the inverter, if present
- Fan outputs
- Global alarm.

Digital inputs

pRack PR100 assigns in order:

- High and low pressure switches (HP and LP)
- Compressor alarms
- Fan alarms

➡ Note: pRack PR100 can also use certain analogue inputs as digital inputs, nonetheless the common HP and LP pressure switches are always associated with actual digital inputs.

Analogue inputs

pRack PR100 assigns in order:

- Pressure or temperature control probes for 1 or 2 lines, according to the settings made. The types of probe assigned as default are 4...20 mA or 0 to 5 V (first 4...20 mA, then 0 to 5 V if necessary) for the pressure probes, NTC for the suction temperature probes and HTNTC for the condensing temperature probes;
- Suction temperature probe on line 1: if possible this is associated with input B3, otherwise the first free input;
- Discharge temperature probe on line 1;
- Suction temperature probe on line 2;
- Discharge temperature probe on line 2.

Analogue outputs

pRack PR100 assigns in order:

- Compressor inverters for 1 or 2 lines;
- Fan modulating devices for 1 or 2 lines.

➡ Note: for pRack pR100 Compact, analogue output 1 is PWM / phase control, and therefore based on the type of modulating devices selected, pRack pR100 assigns the correct output and generates a warning message if this is not possible. For example, if the compressors use an inverter and the fans use phase control, pRack pR100 Compact assigns analogue output 2 to the compressor inverters and analogue output 1 to the fan modulating device.

5. USER INTERFACE

5.1 Graphic terminal

The pRack PR100 user interface is represented by the pGD1 terminal, panel or built-in versions.

The functions associated with the 6 buttons on the pGD1 terminal are the same on all the screens and are described in the table below.

Functions of the 6 buttons

Button		Function associated
	(ALARM)	displays the list of active alarms and accesses the alarm log
Menu		used to enter the main menu tree
Esc		returns to the higher level screen
	(UP)	scrolls a list upwards or increases the value highlighted by the cursor
	(DOWN)	scrolls a list downwards or decreases the value highlighted by the cursor
	(ENTER)	enters the selected submenu or confirms the set value.

Tab. 5.a

The LEDs associated with the buttons have the following meanings.

Meaning of LEDs

LED	Meaning
Red	Flashing: active alarms present and not acknowledged Steady: alarms present and acknowledged
Yellow	pRack PR100 on
Green	pRack PR100 powered

Tab. 5.b

5.2 Description of the display

There are three fundamental types of screens shown to the user:

- Main screen
- Menu screen
- Screen for displaying/setting the parameters

Main screen

The main screen is the screen that the software on board pRack PR100 automatically returns to 5 minutes after the last button was pressed.

An example of the main screen is shown in the figure, highlighting the fields and icons used:

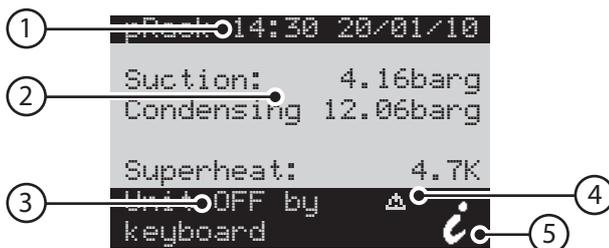

Fig. 5.a

1	Time and date
2	Main values.
3	Unit status (unit off) or compressor and fan status (unit on)
4	Active alarm Signal and manual operation
5	Access further information screens (menu branch A.a) by pressing button

Note: The information shown on the main screen varies according to the system configuration (one line, two lines, two lines with shared condenser) and the type of control value used (pressure or temperature). For two line systems, a parameter is used to select which line is shown first.

Note: The other information shown in menu branch A.a. varies according to the system configuration. For two line systems, pressing from the main screen accesses a different screen based on the starting point (line 1, line 2).

Menu screen

An example of a menu screen is shown in the figure below:

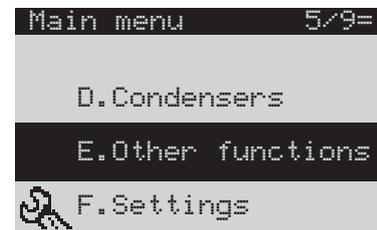

Fig. 5.b

The top right corner shows the selected item and the current password level (for details see the following paragraph). The and buttons are used to select the desired menu item, while accesses the selected item.

Screen for displaying/setting the parameters

An example of a screen for displaying/setting the parameters is shown in the figure, also highlighting the fields and icons used:



Fig. 5.c

1	Menu branch identifier
2	Screen identifier
3	Parameter

The screen identifier uniquely identifies the menu branch and the screen: the first characters indicate the menu branch, while the last two alphanumeric digits identify the order of the screen inside the menu, for example screen Bab01 is the first screen in menu B.a.b.

Note: The information on the screens may vary according to the password level used to access the menu.

5.3 Password

pRack PR100 manages three levels of password:

-  User
-  Maintenance
-  Manufacturer

Each level includes the same rights as the lower levels, that is, the Manufacturer can access all the screens and parameters, the Maintenance can access the screens and parameters available in the Maintenance and User levels, while the User can only access the screens and parameters available in the User level.

 **Note:** All levels display the main screens and the other information screens.

When pressing **Menu** a prompt is shown to enter the password, which remains active for 5 minutes after the last button is pressed.

The menu screens show their own password level using an icon at the top right:  1 line: user,  2 lines: maintenance,  3 lines: manufacturer.

The password level can be changed from menu branch F.d. at any time. The password can also be changed in the corresponding menu branch.

5.4 Description menu

Main menu – Function tree

The following general rules apply to the user interface:

- The parameters are grouped by functions and where necessary repeated, for example the status of the compressors inputs/outputs is visible in both branch C.a.a (Compressors), and in branch B.a (Inputs/Outputs)
- The parameters are grouped by type of access, first User then Maintenance then Manufacturer
- The most frequently used parameters are indicated first, the less frequently used are last
- Each user only sees the parameters and menu items that are available for that access level
- Only the screens and parameters corresponding to the selected system configuration are visible, that is, corresponding to the devices configured. The exception to this rule involves the screens relating to functions that can be enabled/disabled (e.g. set point compensation), which are visible even when disabled.

Regardless of the current screen displayed, pressing the **Menu** button accesses the main menu, as shown below:



🔌	A. Unit Status	a. Main info		
		b. Set Point		
		c. On/Off		
I/O	B. IN/OUT	a. Status	a. Digital in b. Analog in c. Digital out d. Analog out	
		b. Manual OP.	a. Digital out b. Analog out	
		c. Test	a. Digital out b. Analog out	
	🔧	C. COMPRESSORS	a. Line 1 (*)	a. I/O Status b. Control c. OP. hours d. Energy saving e. Alarms f. Config. g. Advanced
			b. Line 2 (*)	...
🌡️	D. CONDENSERS	a. Line 1 (*)	a. I/O Status b. Control c. EEV d. Energy saving e. Alarms f. Config. g. Advanced	
		b. Line 2 (*)	...	
📄	E. Other func.	a. Oil	a. Line 1 (*) b. settings	
		b. Subcool	b. Line 2 (*) ...	
			a. Line 1 (*) a. I/O Status b. settings c. EEV	
		c. Economiser	b. Line 2 (*) ...	
			a. Line 1 (*) a. I/O Status b. settings c. EEV	
		d. Liquid inj.	b. Line 2 (*) ...	
			a. Line 1 (*) a. I/O Status b. settings	
		e. Heat recovery	b. Line 2 (*) ...	
			a. Line 1 (*) a. I/O Status b. settings	
		f. generic func.	b. Line 2 (*) ...	
			a. Stages b. Modulation c. Alarms d. Time bands e. I/O Status	
		g. Chillbooster	a. Line 1 (*) a. I/O Status b. settings	
			b. Line 2 (*) ...	
		h. OSS (*)	a. I/O Status b. settings	
🕒	F. Settings.	a. Clock	a. Time bands b. Adjust	
		b. Languages		
		c. BMS	a. Line 1 (*) b. Line 2 (*)	
		d. Password		
⚠️	G. Safety	a. Log		
		b. Prevent	a. Line 1 (*) b. Line 2 (*)	
		c. Alarm Config.	a. Line 1 (*) b. Line 2 (*)	
?	H. Info			
🔧	I. Setup	a. Pre-configurations		
		b. Wizard		
		c. Advanced Config.		
		d. Default		

(*) this menu level is only visible for system configurations with two lines.

Note:

- The figure illustrates the maximum menu configuration visible with the Manufacturer password. If accessing with the User or Maintenance password, only the menu items available are visible
- For some menu items, access is possible with different password levels (e.g. I/O status), but the information available on the screens changes.

6. FUNCTIONS

pRack PR100 can manage up to 2 suction lines and 2 condenser lines. Many of the functions described in this chapter apply in the same way to all the lines (e.g.: control, rotation), while others apply in the same way to the suction lines (e.g.: oil management). The exception involves the generic functions that apply, irrespective of line, suction or condenser, to pRack boards with pLAN addresses from 1 to 4.

Where not expressly indicated or where it is clear that the description refers to one specific line rather than another (e.g.: compressor or fan management), the descriptions are considered as being common to all lines; any specific Situations are described on a case-by-case basis.

Below is a chart of the main functions described and their field of application:

	Function	L1 suction	L2 suction	L1 condens.	L2 condens.
Control	Unit On-Off	√	√	√	√
	P+I control	√	√	√	√
	Control in Neutral zone	√	√	√	√
	Modulation in Neutral zone	√	√	√	√
	Control with backup probes	√	√	√	√
	Rotation	√	√	√	√
	Modulation device	√	√	√	√
Compressors	Screw compressors	√	-	-	-
	Reciprocating and scroll compressors	√	√	-	-
	Digital Scroll™ compressors	√	√	-	-
Energy saving	Fan management	-	-	√	√
	Set point compensation	√	√	√	√
Accessory functions	Floating set point	√	√	√	√
	Oil management	√	√	-	-
	Subcooling	√	√	-	-
	Economizer	√	√	-	-
	Liquid injection	√	√	-	-
	Heat recovery	-	-	√	√
	Generic functions (*)	(*)	(*)	(*)	(*)
	ChillBooster	-	-	√	√
DSS	√	√	-	-	

Tab. 6.a

(*) not linked to lines, but rather the pLAN address of the boards

The functions are described in detail in the following paragraphs.

6.1 Unit On-Off

The unit can be switched on and off from:

- User terminal
- Supervisor
- Digital input

On-off from the user terminal and the configuration parameters are available under the main menu, branch A.c, and are differentiated based on the access level; the User password allows display only.

On-off from the supervisor and from the digital input and start-up after a blackout (with specific delay, to avoid continuous starts and stops in the event of instability in the power supply) must be enabled using the parameters visible only with the Manufacturer password.

On-off from the digital input is equivalent to an enabling Signal, that is, if the digital input is Off the unit cannot be switched on in any other way, while if is On, the unit can be switched on or off in any other way, with the same priority (the most recent control has precedence, whatever the origin), as shown in the figure:

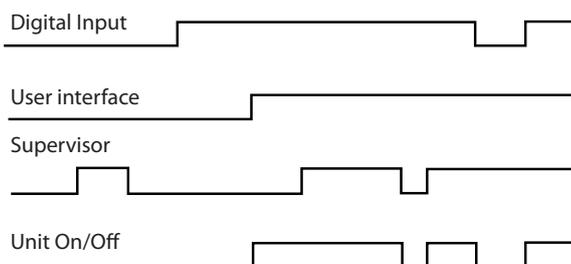

Fig. 6.a

When there are two suction and condenser lines, on-off is independent for each line, while when there are two suction lines and one condenser line, it is independent for the suction lines, while the condenser line stops when both suction lines are off, and starts when at least one suction line is on.

Nota: Certain special conditions or functions in the pRack software cause the unit to shutdown:

- Configuration of some parameters: e.g. inputs/outputs, configuration of compressors, inverter parameters.
- Installation of default parameters
- Manual management

6.2 Control

pRack PR100 can manage two types of control:

- Proportional band (P, P+I);
- Neutral zone (fixed times, variable times).

Both types of control can be applied to both compressors and condensers, according to the settings defined during start-up or in main menu branches C.a.b/C.b.b and D.a.b/D.b.b.

The type of control chosen is independent for each line present, either suction or condenser.

In addition, pRack PR100 can use as the reference for control either the pressure or the converted temperature, or the temperature read by probe if there is no pressure probe, even if reference is only made to pressure below.

The control set point can be compensated by an offset linked to digital inputs, probes, supervisor or time bands, for details see paragraph 6.5 relating to compressor and fan energy saving.

Both types of control are described below, and are valid for both control of suction pressure and condensing pressure, and operation with backup probes and/or probes not working.

6.2.1 Proportional band

The operating principle is normal proportional or proportional + integral control (P, P+I).

The control set point is central, consequently - for proportional control only - operation is schematised in the following figure:

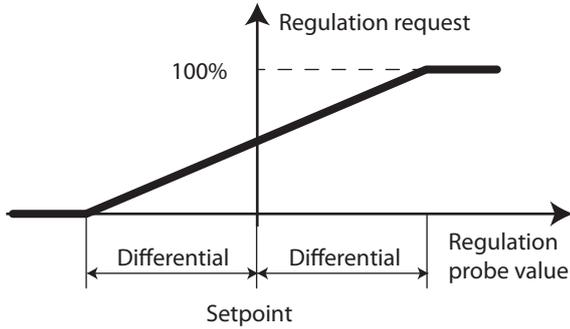

Fig. 6.b

For example, for 4 devices with the same capacity and proportional only control, start-up occurs as shown in the figure:

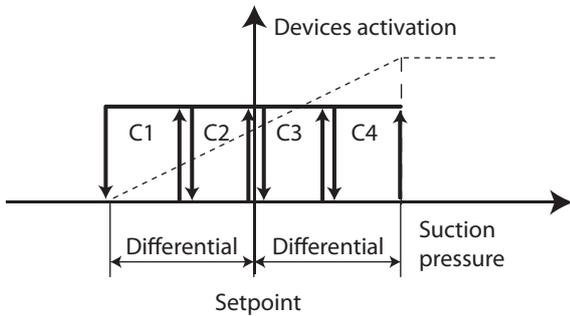

Fig. 6.c

With P+I control, added to the effect of the proportional action described above is the integral action, used to achieve a null control error in steady operation, as shown in the figure:

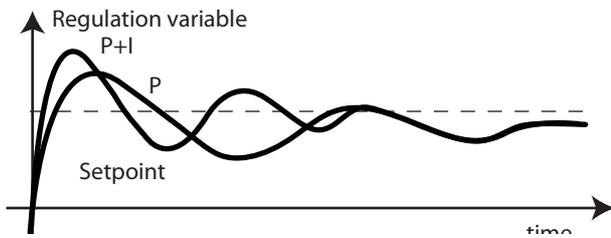

Fig. 6.d

The integral action depends on the time and the deviation from the set point. This modifies the request if the control value does not approach the set point for some time.

The integral time setting represents how fast integral control is implemented:

- low values determine fast and intense control action
- high values determine slower and more stable control action

It is recommended to not set a value that is too low for the integral time, to avoid instability.

Note: the set point is in the centre of the activation band, therefore when reaching the set point some devices are on, even with purely proportional control.

6.2.2 Neutral zone

The operating principle is schematised in the following figure:

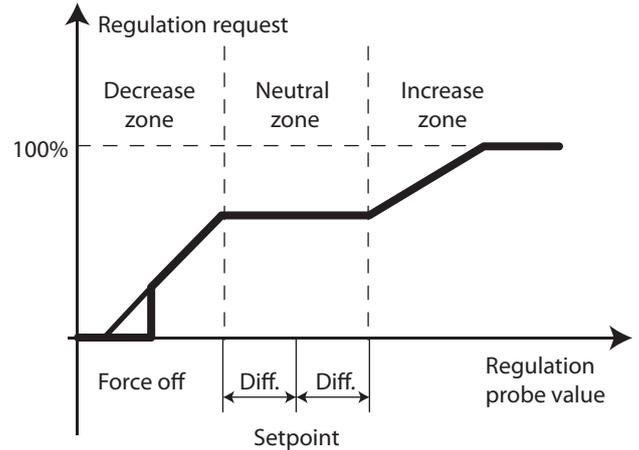

Fig. 6.e

Inside the neutral zone the capacity request sent by the controller is constant (except when there is a modulation device and modulation is enabled inside the neutral zone, as described in the following paragraph) and the value satisfies the temperature control request in those specific operating conditions, therefore within this zone no device is stopped or started.

In the decrease zone, the request also decreases at a rate that depends on the deviation from the set point, and vice-versa in the increase zone the request increases proportionally to the deviation.

For the increase and decrease zones, the following can be used:

- Fixed times: the request decreases or increases constantly as time elapses.
- Variable times: the request decreases or increases more quickly (according to the settings) as the deviation from the set point increases.

Note: The previous figure shows the increase and decrease with fixed times.

For control in Neutral zone, the parameters shown in the figure must be set:

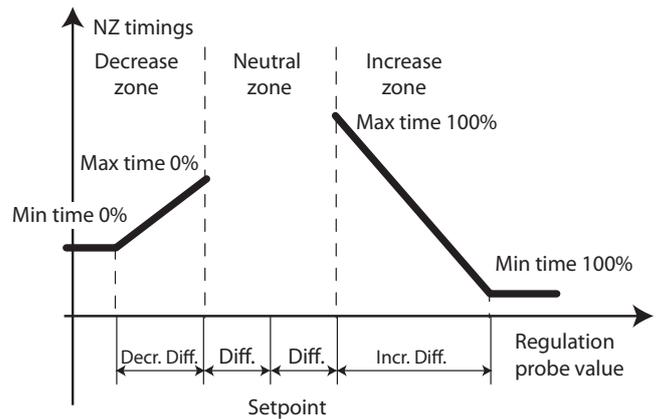

Fig. 6.f

As well as the decrease and increase differentials, 4 times need to be set, two for each zone, which represent the maximum and minimum time to reach the request, equal to 0% or 100%, for the decrease and increase respectively.

Tutorial: the decrease/increase times (minimum and maximum) represent the time needed to change from maximum to minimum capacity and vice-versa, and not the time between the deactivation/activation of the individual device. For example, in the case of 4 devices with the same capacity, an increase time of 180 s means that one device is activated every 45 s.

In the situation shown in the figure, the request sent by the controller decreases/increases slowly as soon as the controlled value is outside of the Neutral zone, while it decreases/increases quickly the further the controlled value moves away from the Neutral zone; in this way the response of the system is faster when further from steady conditions.

Note: When using fixed times, the maximum and minimum must be set to the same value. In this case, the request sent by the controller decreases/increases constantly inside the deactivation/activation differential.

6.2.3 Modulation in Neutral zone

pRack PR100 can activate a specific function inside the Neutral zone if modulating devices are used (e.g.: inverters).

This function can be enabled in main menu branch C.a.g/C.b.g or D.a.g/D.b.g.

Modulation in Neutral zone is used to vary the request sent by the controller inside the Neutral zone proportionally so as to enter the decrease zone with the minimum request and the increase zone with the maximum request, meaning a device can be immediately deactivated/activated when exiting the Neutral zone.

This makes it possible to remain longer inside the neutral zone without starting or stopping any device.

An example of this operation is shown in the figure:

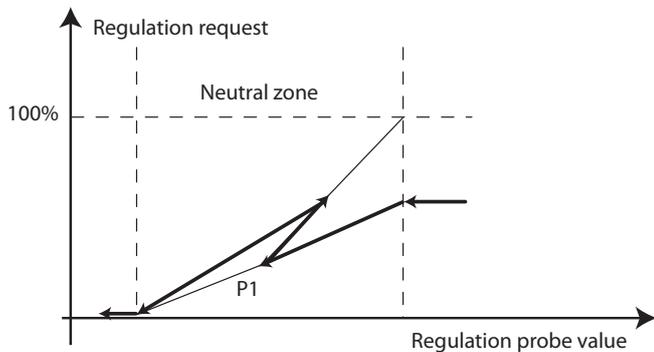

Fig. 6.g

When entering the Neutral zone, the pRack PR100 software calculates how the request needs to change in order to exit the Neutral zone at minimum or maximum output, and applies one of the two values according to the trend in variation in the control variable. For example, at point P1 in the figure, the trend of the two requests is represented by the segments with thin lines, and the request 'reverses' because at that point the control variable has started increasing in value again.

Note: When exiting the Neutral zone, it is possible that the request is not at the minimum or maximum value, where limitation is enabled for of the modulating device variation speed.

6.2.4 Control with backup probes and/or probes not working

pRack PR100 can use backup control probes that are activated when the normal control probes are not working.

The backup probes must be enabled in main menu branch C.a.g/C.b.g or D.a.g/D.b.g.

When different pRack boards are used to manage the suction and condenser lines, the backup suction pressure probe must be connected to the board that manages the suction line, while the backup condensing pressure probe can be connected either to the board that manages the suction line or the board that manages the condenser line.

If the main control probes are not working and no backup probes are fitted, or the backup probes are also not working, or the corresponding temperature probes are also not working, fixed values are used for the control request, set in main menu branch C.a.g/C.b.g or D.a.g/D.b.g.

6.3 Compressors

pRack PR100 can manage up to 2 suction lines with different types of compressors and capacity modulation devices, applying common types of device rotation and controlling both the start mode and the safety times for each type of compressor, as well as a number of accessory functions.

The compressor functions and related parameter settings are enabled from main menu branch C.a/C.b.

These features and functions are described in detail in the following paragraphs.

6.3.1 Possible compressor configurations

pRack PR100 can manage different types of compressors:

- Reciprocating
- Scroll
- Screw

Moreover, a capacity modulation device is allowed for each suction line, which may be one of the following, according to the type of compressor:

Compressors and modulation devices

Compressors	modulation devices
Reciprocating	Inverter
Scroll	Inverter
	Digital Scroll™
Screw	Inverter
	Continuous capacity control

Tab. 6.b

Note: The same modulation device is used on each line.

The maximum number of compressors and load stages per line varied according to the type of compressor:

Compressors and modulation devices

Compressors	Maximum No.	Load stages
Reciprocating	12	24 total
Scroll	12	24 total
Screw	2	4

Tab. 6.c

Note: Screw compressors can only be configured on line 1 and the board must be dedicated only to line 1.

The compressor size refers to its capacity and number of load stages or to the inverter presence, therefore different sizes need to be defined for compressors with the same capacity yet a different number of load stages. The inverter is always associated to size 1.

Tutorial: below is one example of some possible configurations:

- One line, 4 reciprocating compressors with the same capacity, the first with inverter (2 sizes).
- One line, 4 scroll compressors with the same capacity, the first Digital Scroll™ (1 sizes).
- One line, 4 reciprocating compressors with the same capacity, the first two with 4 load stages, the other two not capacity-controlled (2 sizes).
- One line, 4 reciprocating compressors with the same capacity and 4 load stages each (1 size).
- Two lines, line 1 with 2 screw compressors with the same capacity, the first with continuous modulation, line 2 with 4 reciprocating compressors with two different capacities, the first two with 4 load stages, the other two with 2 load stages (1 size on line 1, 2 sizes on line 2).
- Two lines, line 1 with 4 scroll compressors, the first Digital Scroll™, line 2 with 4 reciprocating compressors, the first with inverter (1 size line 1, 2 sizes line 2).

6.3.2 Rotation

pRack PR100 can manage 4 different types of device rotation:

- FIFO (First In First Out): the first device to start is also the first to stop
- LIFO (Last In First Out): the last device to start is the first to stop
- By time: the device with the least number of operating hours starts and the device with highest number of operating hours stops
- Custom: the on/off sequences are defined by the user

Note: Different Sizes of compressors can only be managed with Custom rotation.

The type of rotation is selected and the corresponding parameters set during the start-up procedure or in main menu branch C.a.f/C.b.f.

The activation thresholds are calculated differently depending on whether FIFO, LIFO, time or Custom rotation is used:

Device activation threshold calculation

Rotation	Threshold calculation
FIFO	Static: the range of variation of the control request is divided equally between the number of stages available
LIFO	
By time	Dynamic: the thresholds are calculated depending on the capacity effectively available
Custom	

Tab. 6.d

Example 1: FIFO rotation, 4 compressors of the same capacity without load stages.

The activation thresholds are 25, 50, 75 and 100 %.

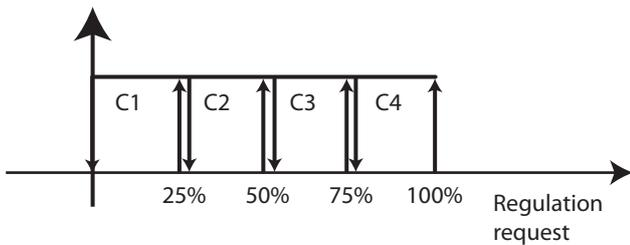

Fig. 6.h

Example 2: Custom rotation, 4 compressors with capacities of 10, 20, 30 and 40 kW. The activation thresholds with all the compressors available are 10, 30, 60, 100 %.

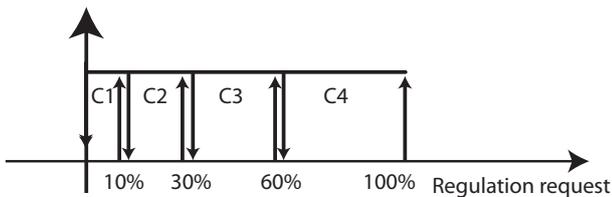

Fig. 6.i

If an alarm is active on compressor 3, the recalculated activation thresholds are 10, 30, 70 %.

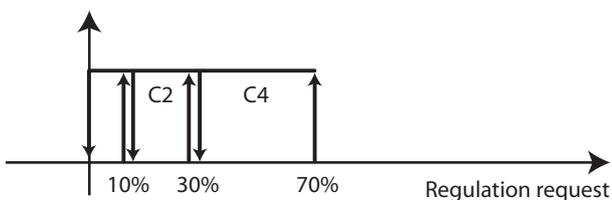

Fig. 6.j

Activation of the compressors and load stages may be:

- Grouped (CpppCppp): first all the load stages are activated on one compressor before starting the next one
- Balanced (CCpppppp): first all the compressors are started at minimum capacity and then the corresponding load stages are activated, one for each compressor, in sequence.

6.3.3 Rotation with modulation devices

pRack PR100 can also manage compressor rotation when a capacity modulation device is fitted (inverter, Digital Scroll™ or continuous control).

The type of modulating device is selected and the corresponding parameters set during the start-up procedure or in main menu branch C.a.f/C.b.f and C.a.g/C.b.g

The modulating device is always the first to start and the last to stop irrespective of the type of rotation, the other devices start or stop according to the type of rotation selected.

Note: The compressor with modulation device is also assumed to be the first.

The trend in capacity delivered by the modulation device depends on the capacity of the compressor with the modulating device compared to the other compressors available.

Three cases can be identified:

- compressors all with the same capacity and range of capacity variation of the modulating device greater than or equal to the capacity of the compressors
- compressors all with the same capacity and range of capacity variation of the modulating device less than the capacity of the compressors
- compressors with different capacities

In the first case, the modulating device manages to continuously cover the range of variation of the control request, while in the second case some discontinuous variations remain. The behaviour in the third case varies according to the capacities involved, and in any case reflects one of the two previous cases.

To configure the compressor capacity when an inverter is used, the minimum and maximum operating frequencies need to be set relating to the minimum and maximum value of the analogue output and the rated capacity delivered at rated frequency (50 Hz), so that the pRack PR100 software can calculate the capacity the compressor can deliver with the inverter and use this value for control. In addition, for inverters the variation in capacity delivered can be limited by setting the increase and decrease times. If these times have already been configured on the inverter, the higher time set has priority.

Example 1: range of modulating device capacity variation higher than the capacity of the compressors:

two compressors without capacity control, with the same capacity, 20 kW each, modulating device with variable capacity between 30 and 60 kW. The figure shows the trend when the request sent by the controller increases and then decreases continuously between 0 and 100 %. It can be seen that the capacity delivered exactly follows the required capacity, except when below the minimum capacity of the modulating device.

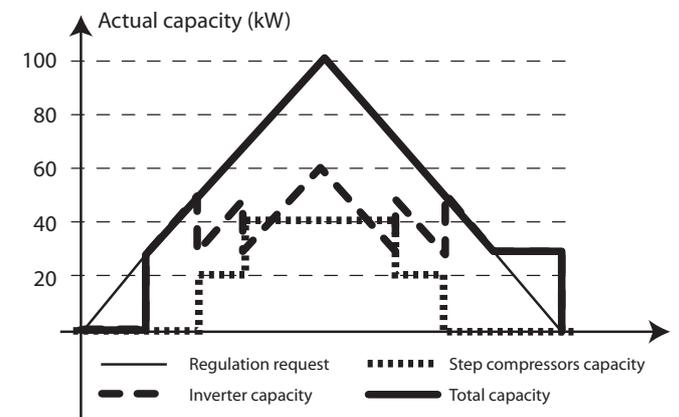

Fig. 6.k

Example 2: range of modulating device capacity variation lower than the capacity of the compressors: two compressors without capacity control, with the same capacity, 30 kW each, modulating device with variable capacity between 20 and 40 kW. It can be seen that the capacity delivered does not exactly follow the required capacity, rather acts in steps, so as to avoid swings.

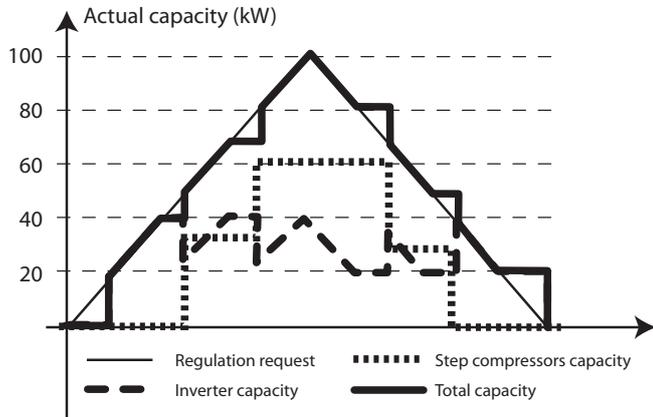

Fig. 6.l

Esempio 3: range of modulating device capacity variation in between the capacity of the compressors, all different sizes: two compressors without capacity control, capacities 15 kW and 25 kW, modulating device with variable capacity between 10 and 30 kW.

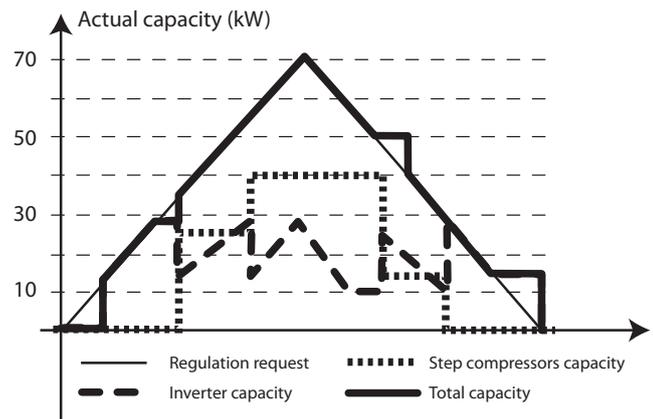

Fig. 6.m

6.3.4 Starting

pRack PR100 can manage different types of compressor starting:

- Direct
- Part-winding
- Star/delta

The type of starting can be selected and the related parameters set in main menu branch C.a.f/C.b.f.

For part-winding starting, the delay in activating the digital output that controls the second winding needs to be set:

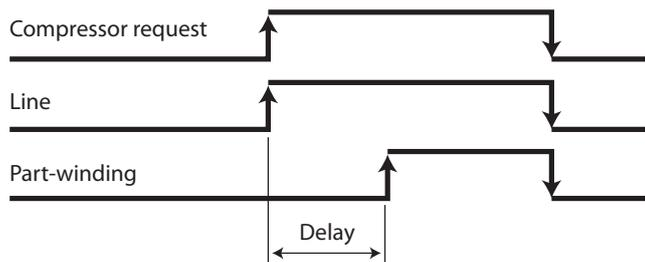

Fig. 6.n

For star/delta starting, the star time, the delay between the activation of the line and star digital input, and between the delta and star digital input all need to be set, as shown in the figure:

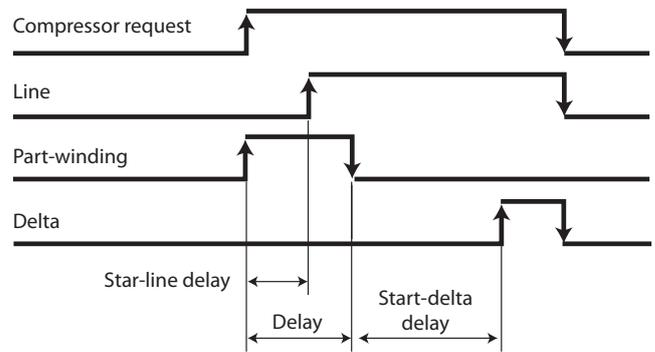

Fig. 6.o

6.3.5 Safety times

pRack PR100 can manage common safety times for each compressor:

- Minimum on time
- Minimum off time
- Minimum time between consecutive starts

In addition, pRack PR100 can manage the specific times for Digital Scroll™ compressors and screw compressors; for the descriptions see paragraphs 6.3.10 and 6.3.11.

The related parameters can be set in main menu branch C.a.f/C.b.f.

Note: for two lines, a further delay can be set between starts of the compressors on different lines, so as to avoid Simultaneous starts. See paragraph 6.6.6 for the detailed description of the synchronisation function for two lines (DSS).

6.3.6 Balancing

pRack PR100 can control any balance valves in parallel with the compressors.

This function can be used to activate a communicating solenoid valve between compressor suction and discharge, for a set time, before each individual compressor starts. In this way, the suction and discharge pressure can be balanced and the compressor can be started in more favourable conditions.

The balancing function can be enabled and the related activation time set in main menu branch C.a.f/C.b.f.

6.3.7 Economizer

pRack PR100 can activate the economizer function to boost compressor efficiency by injecting vapour. Some of the liquid is taken from the condenser, expanded through a valve and then sent to a heat exchanger to cool the liquid leaving the condenser. The resulting superheated vapour is injected into a special section of the compressor.

The function can be enabled and the related parameters set in main menu branch C.a.f.

The function can be enabled and the related parameters set in main menu branch C.a.f.

The economizer is only efficient for high compressor activation capacities, typically over 75 %, therefore the economizer function control valve is only activated when exceeding a set threshold.

As the economizer tends to increase the condensing pressure alarm is not generated. In addition, the injection of vapour decreases the discharge temperature and so this value also needs to be monitored.

Consequently, the three conditions for activation of the economizer function are:

- Capacity above a set threshold
- Condensing pressure below a set threshold (with reset differential)
- Discharge temperature above a set threshold (with reset differential)

Note: the function can be activated on a maximum of 6 compressors.

6.3.8 Liquid injection

As an alternative to the economizer, pRack PR100 can manage the injection of liquid into the compressors (the two functions are alternative, as the point of vapour injection into the compressor is the same).

The function can be enabled and the related parameters set in main menu branch E.d.a.b/E.d.b.b.

Liquid injection is used to protect the compressor, and in fact decreases the discharge temperature.

Operation is similar to the economizer function, with the difference that the expanded liquid is not sent to a heat exchanger, but rather directly into the compressor. The function is only activated when the compressor is on and the discharge temperature exceeds a set threshold (with differential).

Note: the function can be activated on a maximum of 6 compressors.

6.3.9 Manual operation

pRack PR100 can manage 3 different compressor manual operating modes:

- Enabling / disabling
- Manual management
- Output test

Enabling / disabling is managed in main menu branch C.a.f/C.b.f., while manual management and the output test can be activated in main menu branch B.b or B.c.

Enabling / disabling is used to temporarily exclude the compressors from operation, to allow, for example, repair or replacement. The disabled compressors are also excluded from rotation.

Note: enabling is the only compressor manual operating mode that can be activated when the unit is on.

Both manual management and the output test are enabled by parameter and remain active for a set time after the last button is pressed, after which the unit returns to normal operating mode.

Manual management is used to switch the compressors on or off without observing the control needs, however still considering any safety devices (alarms, safety times, starting procedures) and respecting the set configuration of the inputs/outputs.

The activation screen resembles the one shown in the figure and is used to override the outputs relating to the operation of the selected device, e.g. compressor 1:

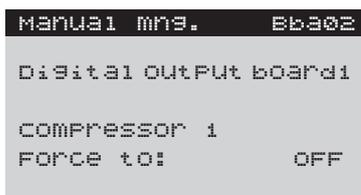

Fig. 6.p

The output test is used to activate or deactivate the outputs (where necessary setting an output percentage for the analogue outputs), without observing any type of safety feature.

The activation screen resembles the one shown in the figure and is used to override the outputs on the pRack boards, in the order they physically appear on the board (without links to the devices):

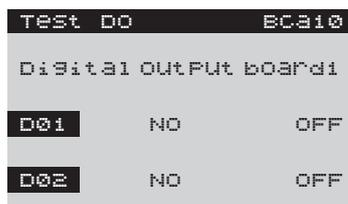

Fig. 6.q

Important: manual mode and the output test can only be activated with the unit off.

Both manual mode and above all the output test must be used with special care and by expert personnel to avoid damage to the devices.

6.3.10 Digital Scroll™ compressors

pRack PR100 can use a Digital Scroll™ compressor as the modulating device for suction lines (one for each line). This type of compressor features special operation, and is controlled by pRack PR100 as follows.

The related parameters can be set in main menu branch C.a.f/C.b.f.

The capacity is modulated by opening/closing a valve with PWM; when the valve is ON the compressor delivers minimum capacity, while when the valve is off the compressor delivers maximum capacity. In the following description and figure, ON and OFF refer to the status of the compressor, while operation of the valve is the exact opposite:

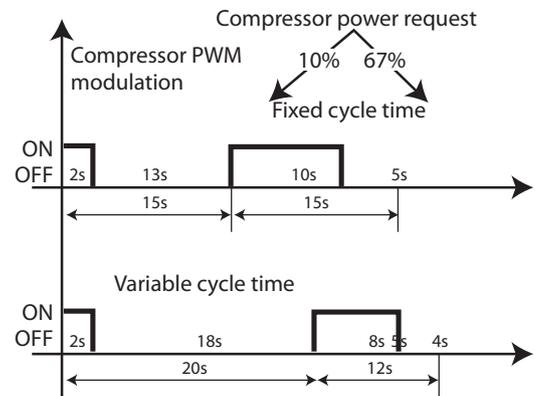

Fig. 6.r

The following data are provided by the manufacturer of the compressor:

- minimum ON time 2 s
- maximum cycle time 20 s
- optimum cycle time 12 s

There are three possible operating modes:

- Fixed cycle time
- Variable cycle time
- Optimised cycle time

Based on the operating mode selected, pRack PR100 calculates the valve activation percentage that satisfies the required capacity.

Fixed cycle time

The compressor ON time is calculated as the percentage of the cycle time corresponding to the required capacity:

$$T_{ON} = \% \text{ Richiesta} * \text{Tempo di ciclo}$$

The cycle time can be set to the optimum value suggested by the manufacturer to achieve maximum COP, or to a higher value to increase resolution of the capacity delivered (a higher cycle time implies greater continuity in the effective capacity that can be delivered).

Variable cycle time

The compressor ON time is set to 2 s and the cycle time is calculated based on the required capacity:

$$T_{CICLO} = T_{ON} / \% \text{ Richiesta}$$

Optimised cycle time

The compressor ON time is set to 2 s and the cycle time is calculated based on the required capacity for capacities less than 17 %, after which the cycle time is set to 12 s and the ON time varies. In essence, this mode is a combination of the previous two.

This guarantees the maximum possible COP and control rate (obtained with the 12 s cycle time) and the maximum control range (starting from 10 %).

Note: the minimum capacity that can be delivered by Digital Scroll™ compressors is Minimum ON time/Maximum cycle time = 2/30 = 6.7 %, which also depends on the selected control mode (for example, in the first case shown in the figure the minimum capacity delivered is Minimum ON time/Cycle time = 2/15 = 13%).

Note: if high pressure prevention is enabled with activation/deactivation of the devices, the Digital Scroll™ compressor delivers the minimum possible capacity.

Starting procedure

pRack PR100 can manage the specific starting procedure for Digital Scroll™ compressors, as represented as in the following figure:

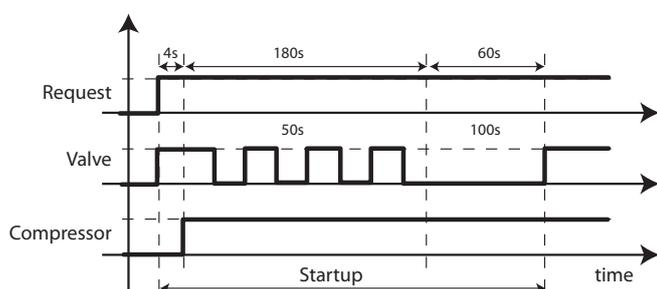

Fig. 6.s

There are three stages:

1. balance: the PWM valve is activated for 4 s, so that the compressor delivers minimum capacity;
2. compressor activation with 50 % capacity for 3 minutes;
3. forced operation at 100 % for 1 minute.

During the starting procedure, the request sent by the controller is ignored and only at the end of the procedure does the capacity delivered start reflecting the request. If the request is cancelled during the starting procedure, the compressor stops at the end, then the minimum ON time for these types of compressors is set to 244 s.

The starting procedure is performed when the compressor is started, while it can be disabled for a set time by parameter for subsequent starts, if the compressor has not remained off for a minimum set time. After this time has elapsed the procedure is performed again during the following start.

Note: the safety times for Digital Scroll™ compressors are established by the manufacturer, and are as follows:

- Minimum ON time: 244 s (starting procedure)
- Minimum OFF time: 180 s
- Minimum time between restarts: 360 s

Alarms

pRack PR100 can manage, in addition to the common alarms for all types of compressors (see chapter 8 for details), some specific alarms for Digital Scroll™ compressors:

- high oil temperature
- oil dilution
- high discharge temperature

These alarms are managed as specified by the manufacturer of the compressor, and therefore pRack PR100 can only enable or disable them. Activation of these alarms requires an oil temperature probe, which can also be the common probe (see the paragraph relating to oil management) and the compressor discharge temperature probe.

Note: pRack PR100 does not manages the envelope for Digital Scroll™ compressors and consequently there is no corresponding alarm when operating outside the envelope.

6.3.11 Screw compressors

pRack PR100 can manage up to two screw compressors, with control in stages or continuous control (only the first compressor with continuous control, used as modulation device for the suction line), which can be a generic device or pre-configured in accordance with the most common devices supplied by the main manufacturers.

Advanced functions are also available, for example envelope control, described further on.

The parameters relating to screw compressors can be set in main menu branch C.a.f/C.b.f.

The parameters relating to screw compressors can be set in main menu branch C.a.f/C.b.f.

Screw compressors are fitted with up to 4 capacity control valves (hereinafter V1, V2, V3, V4), which can have 4 types of behaviour:

- ● ON: the valve is open
- ○ OFF: the valve is closed
- ●/○ Intermittent: the valve is open/closed alternatively (around 10 to 15 s)
- ●/○ Pulsating: the valve is open/closed alternatively with very short opening/closing times (around 1 to 2 s).

Important: pulsating valves must be associated with an SSR relay output, to avoid damage.

V1, V2, V3 and V4 can be managed to obtain stage or continuous compressor control.

Stage control

For the control in stages, normally involving four load stages, 25, 50, 75, 100 %, a table needs to be created that shows the behaviour of each valve in the different conditions (starting, 25 %, 50 %, 75 %, 100 %). The figure shows one possible example (see the documents supplied by the manufacturer of the compressor for how to complete the table):

	V1	V2	V3	V4
Start	○	○	○	○
25%	○	●	●	○
50%	●	○	●	●
75%	○	○	●	○
100%	○	○	○	○

Tab. 6.e

If intermittent valves are used, the cycle time also needs to be set.

Note: normally operation at minimum capacity (25 %) is only possible for a limited time, after which the compressor must switch to the next stage. This function can be enabled and the corresponding time can be set.

Continuous control

For continuous control, a table needs to be created that shows the behaviour of each valve in the different conditions (start/stop, increase, decrease, standby). The figure shows one possible example:

	V1	V2
Start/Stop	○	○
Increase (25 to 100%)	●	○
Decrease (25 to 100%)	○	●
Standby	●	○

Tab. 6.f

If intermittent/pulsating valves are used, the cycle time also needs to be set. Intermittent valves are opened/closed for 50 % of the set time, while for pulsating valves the opening and closing time in theory depend on the difference between the position of the slide and the capacity request. As the position of the slide is generally not measurable, the variation in the request is used to calculate the times for pulsating valves.

Note: in continuous control, operation is normally only allowed for an undetermined time when the capacity exceeds 50 %.

Starting procedure

pRack PR100 can manage the starting procedure for the screw compressors by considering, following the star/delta or part-winding starting selected, a further time of operation at minimum capacity, established by the manufacturer or set to 60 s for generic compressors.

Once the starting procedure has ended, the compressor starts varying the capacity according to the control request and if necessary considering the duration at minimum capacity.

Series of compressors supported

pRack PR100 can manage several series of screw compressors made by the main manufacturers, (Bitzer, Refcomp, Hanbell, ...) which come with the parameters described above already set.

The models managed by pRack PR100 are shown in the table:

Manufacturer	Model
Bitzer	CSH65...95, HS.53-4/64, HS.74, HS85
Hanbell	RC2-100/140/180, RC2-170/200...1520
RefComp	134-S, 134-XS L1, 134-XS L2, SRS-S1XX...755, SRC-S785...985, SRC-XS L1, SRC-XS L2

Tab. 6.g

For manufacturers or series of compressors that are not supported, the generic type can be used and the corresponding parameters set as described previously.

Note: for further details on the series of compressors supported and the related pre-configured parameters, contact Carel.

Envelope

For screw compressors, pRack PR100 can manage control of the envelope, which can either be pre-set or defined by the user. pRack PR100 accepts the envelope control settings for the Bitzer CSH series compressors, and these simply need to be enabled in main menu branch C.a.g.

For all other series of compressors, the envelope can be managed by enabling and setting all the related parameters in main menu branch C.a.g.

The following parameters need to be set in order to manage the envelope:

- Definition of the points (maximum 30)
- Definition of the zone (maximum 12). Each zone can be made up of one or more polygons (total maximum 14, which must be closed and convex)
- Definition of the behaviour of the compressor in the different zones (capacity and duration)

The meaning of the parameters is shown in the figure:

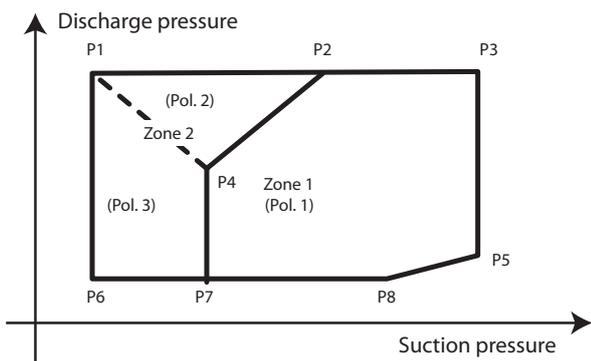

Fig. 6.t

pRack PR100 can also manage the variation in the envelope as the capacity delivered changes, for example in the case of variation in frequency for inverter-driven compressors.

Note: for further details on configuration of the envelope, contact Carel.

6.4 Fans

pRack PR100 can manage up to 2 condenser lines with up to 16 fans and one speed modulation device each, applying common types of device rotation and controlling both the starting mode and some accessory functions.

The modulation device may be an inverter or a phase fired controller.

The fan functions and related parameter settings are enabled from main menu branch D.a./D.b.

The functions are described in detail below.

6.4.1 Control

pRack PR100 can manage - as described in paragraph 6.2 - proportional band and Neutral zone control, by pressure or temperature.

For details on the control modes, see the corresponding paragraph, while below is the description only of the features relating to the fans.

Fan operation depending on the compressors

The operation of the fans can be bound to the operation of the compressors by setting a parameter in main menu branch D.a.b./D.b.b, in this case the fans only start if at least one compressor is on. This setting is ignored if the fans are controlled by a dedicated pRack PR100 board and the pLAN network is disconnected.

Fan operation with modulating device

If the fans are controlled by a modulating device, the meaning of the parameters that associate the minimum and maximum values of the device's modulating output and the minimum and maximum capacity of the modulating device on screens Dag02 and Dbg02 is illustrated in the following examples.

Example 1: minimum modulating output value 0 V, maximum value 10 V, minimum modulating device capacity 0 %, maximum 100 %.

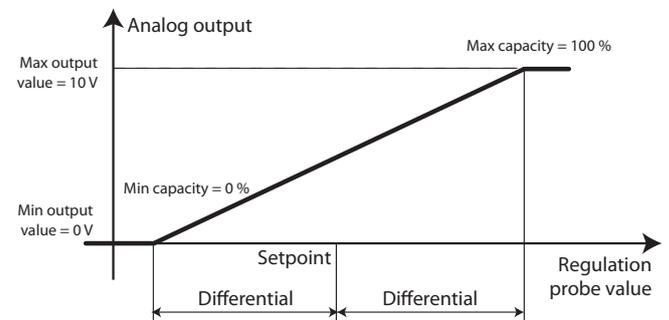

Fig. 6.u

Example 2: minimum modulating output value 0 V, maximum value 10 V, minimum modulating device capacity 60 %, maximum 100 %.

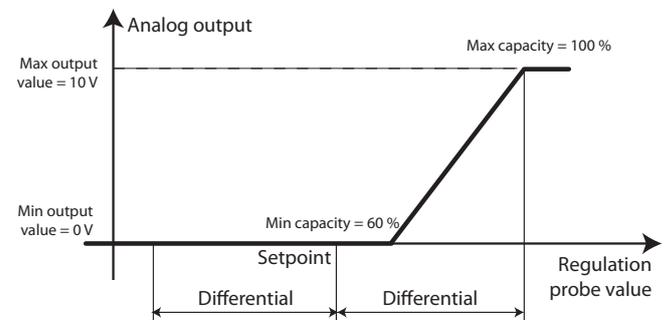

Fig. 6.v

Example 3: minimum modulating output value 2 V, maximum value 10 V, minimum modulating device capacity 60 %, maximum 100 %.

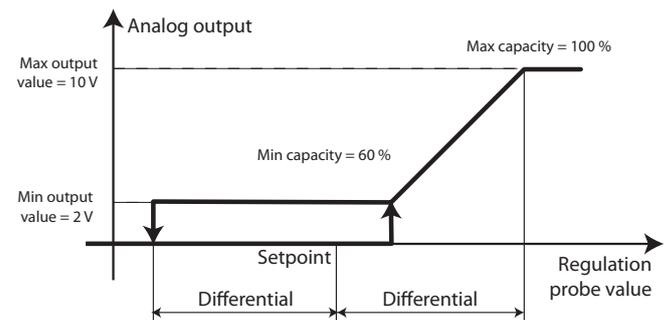

Fig. 6.w

Cut-off

pRack PR100 manages a control cut-off for the fans; functions and related parameter settings can be enabled from main menu branch D.a.b/D.b.b.

The operating principle of the cut-off function is shown in the figure:

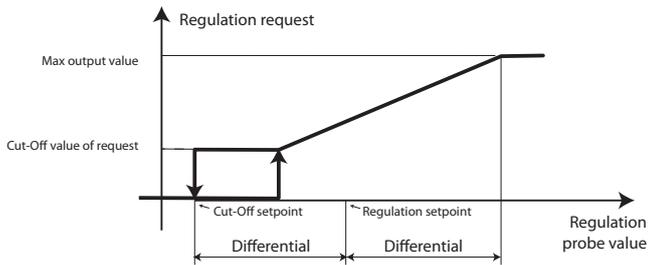

Fig. 6.x

A percentage of the control request and a cut-off set point can be set. When the control request reaches the set cut-off value, this value is kept constant until the control value falls below the cut-off set point, after which it falls to 0 % and remains there until the request exceeds the cut-off value again.

6.4.2 Rotation

pRack PR100 can manage rotation of the fans, much in the same way as described for the compressors, therefore:

- LIFO, FIFO, time, Custom rotation
- Management of a modulation device on each line

The substantial difference compared to the compressors concerns the possibility to manage different capacities and load stages, which are obviously not featured for the fans. In addition, pRack PR100 can specially manage inverter driven fans. In fact, a multiple number of inverter driven fans can be set.

If there is more than one fan, however the number of inverter driven fans is set to 1, the fans are started and stopped at the same time, and the fans will always all be at the same power.

If there is more than one inverter driven fan, as well as being able to use an alarm digital input for each, it is assumed that the weight of the modulating device is proportional to the number of fans, therefore the first case is applied, as described in paragraph 6.3.3: fans all with the same power and modulating device power variation range greater than or equal to the capacity of the other devices.

Example 1: 4 fans all controlled by the same inverter correspond to 1 fan with four times the power.

Note: some fans can be excluded from the rotation, for example in the winter; to do this use the split condenser function described in paragraph 6.4.5.

6.4.3 Fast start (speed up)

pRack PR100 can manage the fast start function (speed up), used to overcome the initial inertia of the fans.

The function can be enabled and the related parameters set in main menu branch D.a.g/D.b.g

If speed up is enabled, a start time can be set in which the fan speed is forced to 100%. If the outside temperature sensor is used, moreover, a threshold can be set (with reset differential) below which speed up is disabled, so as to not drastically lower the condensing pressure at start-up.

Note: speed up has lower priority than the Silencer function (see the following paragraph for the details), therefore if the Silencer function is active, this is disabled.

6.4.4 Silencer

pRack PR100 can manage the Silencer function, used to limit fan speed at certain times of the day or in specific conditions, enabled by digital input.

The function can be enabled and the related parameters set in main menu branch D.a.g/D.b.g.

Enabling fan speed limitation from the digital input or based on time bands is independent, consequently the speed is limited to the set value when at least one of the two conditions is active.

Up to 4 activation bands can be set for each day of the week.

6.4.5 Split condenser

pRack PR100 can manage the possibility to exclude some fans from operation, for example to reduce condenser operation in winter, using the split condenser function.

The function can be enabled and the related parameters set in main menu branch D.a.g/D.b.g.

Split condenser can be used to exclude from rotation fans whose index is:

- even
- odd
- higher than a settable value
- lower than a settable value

The function can be activated by:

- time bands (winter/summer seasons)
- digital input
- supervisor
- outside temperature (set threshold and differential)

Note:

- the split condenser function can be disabled by parameter if the high pressure prevention function is activated (see paragraph 8.3.3). If split condenser is disabled due to activation of the high pressure prevention function, it remains disabled for a set time, after which it is reactivated.
- split condenser cannot be enabled if there is a speed modulation device that controls all the fans.

6.4.6 Manual operation

pRack PR100 can also manage the same three manual operating modes for the fans as described for the compressors:

- Enabling
- Manual management
- Output test

Enabling is managed in main menu branch D.a.f/D.b.f., while manual management and the output test can be activated in main menu branch B.b or B.c.

For the detailed description of the three modes, see paragraph 6.3.9.

6.4.7 Alarms

pRack PR100 can manage both a common alarm for the fans and separate alarms for each fan.

When the common alarm is active the alarm is signalled, but no fan is stopped, while for separate alarms the fan that the alarm refers to is stopped.

For details on the fan alarms, see Chapter 8.

6.5 Energy saving

pRack PR100 can activate energy saving functions by adjusting the suction and condensing pressure set points.

The suction and condensing pressure set points can be applied with two different offsets, one for the closing period and one for the winter period, activated by:

- Digital input
- Time band
- Supervisor

In addition, the suction pressure set point can be modified from analogue input, applying a linearly variable offset based on the value read by a probe.

As well as set point compensation from digital input, scheduler, supervisor or analogue input, two further energy saving functions are available, floating suction and condensing pressure set point.

The functions can be enabled and the related parameters set in main menu branch C.a.d/C.b.d and D.a.d/D.b.d.

6.5.1 Set point compensation

Compensation from digital input, scheduler or supervisor is similar for the suction and condensing pressure set points, consequently the following description applies to both.

Two different offsets can be defined, which apply to:

- Closing periods, defined by the scheduler, activation of a digital input or supervisor
- Winter period, defined by the scheduler

The two offsets add to the set point defined by the user when the corresponding condition is active.

Example 1: closing offset 0.3 barg, winter offset 0.2 barg, suction pressure compensation from scheduler and from digital input activated. When the digital input is activated, for example with a day/night function, 0.3 barg is added to the operating set point, and when the winter period is in progress a further 0.2 barg is added. The operation can be schematised in the following figure:

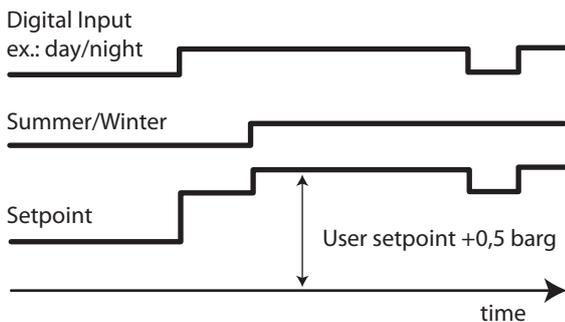

Fig. 6.y

Note: the same digital input is used for set point compensation on each line, so if suction and condensing pressure set point compensation is activated by digital input, both compensation functions are active at the same time.

Compensation from analogue input only applies to the suction pressure set point and can be enabled separately.

If compensation from analogue input is enabled, a offset that is linearly variable to the value read by a dedicated probe can be applied to the suction pressure set point, as shown in the figure.

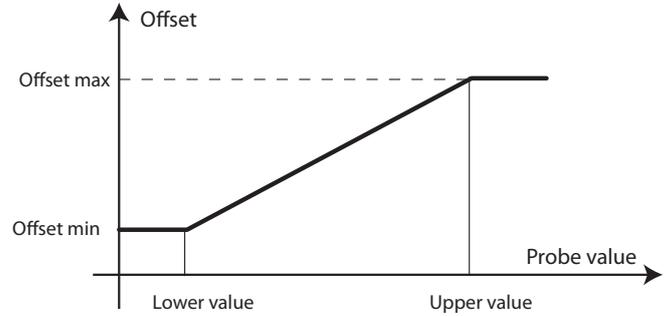

Fig. 6.z

6.5.2 Floating suction pressure set point

For the suction line, the floating set point is managed by the supervisor.

The suction pressure set point set by the user is changed by the supervisor in range between a settable minimum and maximum. The operation is illustrated in the following figure:

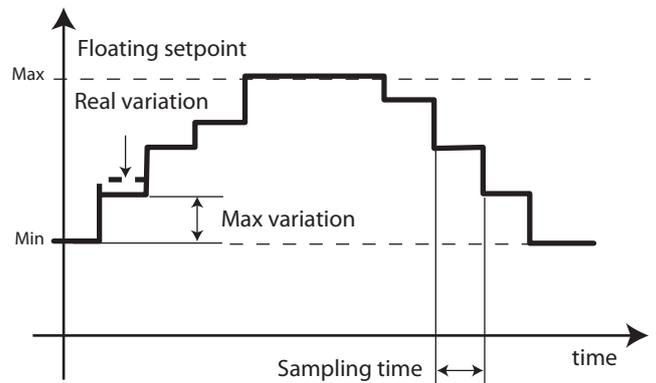

Fig. 6.aa

The set point is calculated by the supervisor and acquired by the pRack PR100 controller at set intervals, the maximum variation allowed for the set point in each sampling period can also be set; if the value acquired differs from the previous value by more than the maximum variation allowed, the variation is limited to the maximum value.

If the supervisor is disconnected, after 10 minutes (fixed) the pRack PR100 controller starts decreasing the set point with variations equal to the maximum variation allowed each sampling period, until reaching the minimum set point allowed with floating suction pressure.

Note: if set point compensation from scheduler, digital input or supervisor is also active, the offset is added to the minimum and maximum limits for the floating set point.

6.5.3 Floating condensing pressure set point

For the condenser line, the floating set point is based on the outside temperature. The floating condensing pressure set point is achieved by adding a constant programmable value to the outside temperature and limiting the resulting value between a settable minimum and maximum, as shown in the figure:

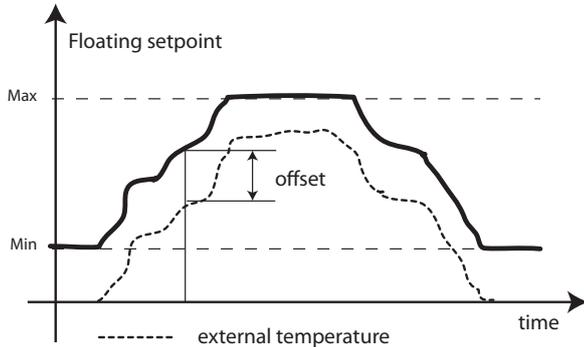

Fig. 6.ab

Note: if set point compensation from scheduler, digital input or supervisor is also active, the offset is added to the minimum and maximum limits for the floating set point.

6.6 Accessory functions

pRack PR100 can manage several accessory functions. Of these, the economizer and liquid injection have already been described in paragraph 6.3 on compressor operation, while the others are described below.

6.6.1 Oil management

pRack PR100 features oil management for the individual compressors, as well as common management for each line:

- Individual compressor: oil alarm, high oil temperature, and, for screw compressors only, oil warning, oil cooling and oil level
 - Line: common oil alarm, high oil temperature warning, oil cooling
- The function can be enabled and the related parameters set in main menu branch E.a.a/E.a.b or C.a.e/C.b.e (for the individual compressor alarms).

Individual compressor oil management

For the description of the oil alarm and warning corresponding to the individual compressor see Chapter 8.

For screw compressors, an oil cooler can be managed for each compressor, made up of a heat exchanger, a fan and 1 or 2 pumps.

The operation of the cooler varies according to the setting of the output, which may be:

- Analogue: one pump only
- Digital: 1 or 2 pumps

The control probe is the compressor oil temperature probe, and the following need to be set: set point, differential and, for 2 pumps only, an activation delay for the second pump. The operation of the cooler when using an analogue output is shown in the figure:

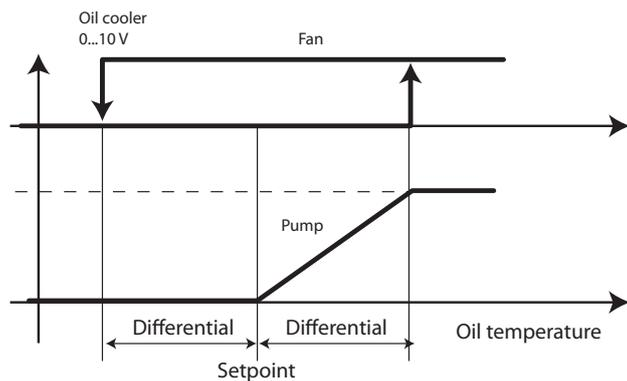

Fig. 6.ac

If a digital output and just one pump is used, the fan and the pump are activated/deactivated at the same time:

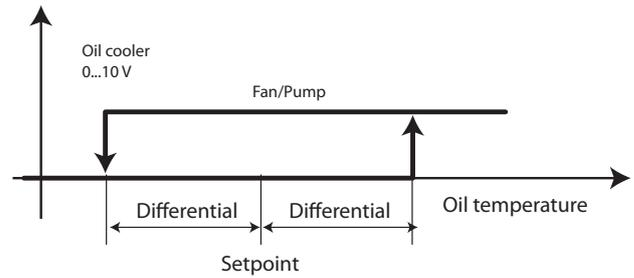

Fig. 6.ad

If a digital output and two pumps are used, the operation of the fan and the first pump is similar to the previous case, while the second pump is activated when the oil temperature is greater than the set point + differential for a time at least equal to the delay, and is deactivated when the oil temperature falls back below the set point minus the differential.

The oil level can be managed for the first 6 compressors on each suction line. If a compressor alarm is configured as an oil alarm, this alarm can be associated with oil level management, enabling the function and setting the compressor alarm number to be used: when the digital input associated with the alarm is activated (this thus signals the low oil level), a valve is activated with intermittent operation to restore the level, with opening and closing times that can be set. If after a set time, the digital input is still active, that is, the minimum level has not been reached, pRack PR100 signals an alarm and stops the compressor.

Line oil management

pRack PR100 features an alarm digital input for each line; this is with signal only, that is, has no effect on the operation of the devices. For details on this alarm see chapter 8.

For all types of compressors, a common oil cooler can be managed for each line; the operation of this is similar to the cooler for each individual compressor described previously.

Note: for screw compressors, if common cooling is selected, cooling for each compressor cannot be activated.

6.6.2 Subcooling

pRack PR100 can control subcooling in two different ways:

- with the condensing temperature and the liquid temperature
- with the liquid temperature only

In the first case, subcooling is calculated as the difference between the condensing temperature (obtained by converting the condensing pressure) and the liquid temperature measured after the exchanger.

The corresponding output is activated below a set threshold, with fixed differential.

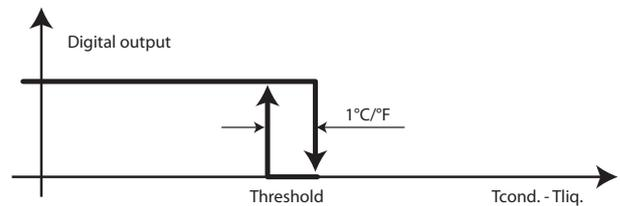

Fig. 6.ae

In the second case, the output is active for liquid temperature values greater than a threshold, with fixed differential.

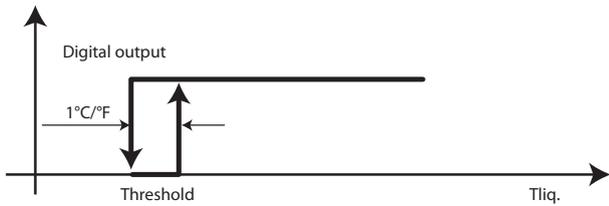

Fig. 6.af

The subcooling function can be enabled and the related parameters set in main menu branch E.b.a/E.b.b.

Note: the subcooling function is active when at least one compressor is on.

6.6.3 Heat recovery

pRack PR100 can manage heat recovery for types of system with heat recovery in series with the main condenser.

Heat recovery can be activated by:

- Probe
- Time bands
- Supervisor

The heat recovery function can be enabled and the related parameters set in main menu branch E.e.a/E.e.b.

A digital input is managed that acts as a trigger for activating the function. When the digital input is not active, heat recovery is not operating, while when the digital input is active heat recovery is operating when at least one of the other conditions is true, as shown in the figure:

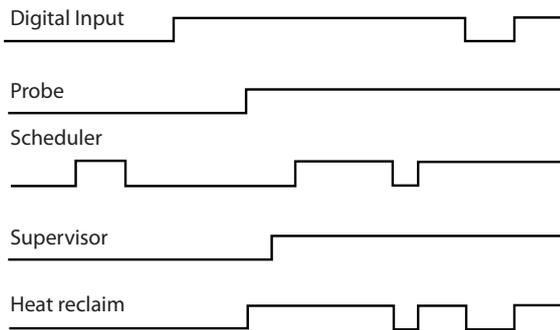

Fig. 6.ag

If the digital input is not configured, only the other conditions are taken into consideration.

When the heat recovery function is active, a digital output is activated to trigger the pump and a digital or analogue output for an On/Off or modulating 3-way valve.

For activation by probe, the operation of the On/Off or modulating 3-way valve and the pump is shown in the figure, where the temperature considered is the heat recovery exchanger outlet temperature:

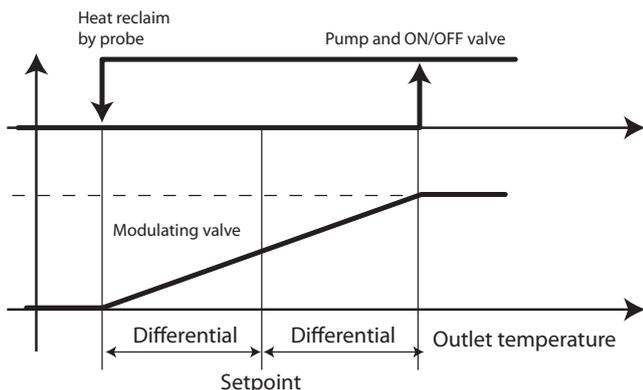

Fig. 6.ah

If the probe is not working, pRack PR100 considers the other conditions, without Signalling further alarms in addition to the probe alarm.

As regards activation from time bands, heat recovery does not consider the operating seasons, and links can be set to special days and closing periods so that heat recovery is only active based on the daily bands set.

Note:

- a settable bottom limit is available for the condensing pressure, below which heat recovery is deactivated.
- condensing pressure set point compensation can be disabled when heat recovery is active..

Heat recovery as the first stage in high pressure prevention

Heat recovery can be used to prevent high condensing pressure. The parameters relating to this function can be set in branch G.b.a/G.b.b of the main menu, after having enabled the heat recovery function.

For details on operation of the prevent function, see paragraph 8.3.3. Heat recovery operation as the first stage in high pressure prevention is shown in the figure:

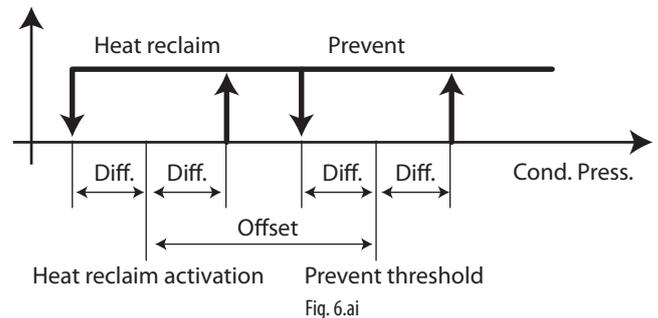

Fig. 6.ai

The function must be enabled and an offset must be set in relation to prevent threshold, while the differential is the same set for the prevent function.

6.6.4 Generic functions

pRack PR100 can use the free inputs /outputs and certain internal variables for generic functions.

Important: The generic functions are available on pRack PR100 boards with pLAN addresses from 1 to 4, that is, on all boards that manage a suction or condensing line, nonetheless only the parameters corresponding to the functions managed by boards 1 and 2 are sent to the supervisory system.

The following generic functions are available for each board:

- 5 stages
- 2 modulations
- 2 alarms
- 1 scheduler

Each function can be enabled/disabled by digital input and from the user interface.

The generic functions can be enabled and the related parameters set in main menu branch E.f.

To be able to use the free inputs, these must be configured as generic probes from A to E (analogue inputs) and generic inputs from F to J (digital inputs), consequently a maximum of 5 analogue and 5 digital inputs can be used. After having configured the generic probes, the associated variables can be used as control variables and the digital inputs as enabling variables.

As well as the generic probes and inputs, pRack PR100 software internal variables can be used, depending on the system configuration. Some examples are, for analogue variables:

- Suction pressure
- Condensing pressure
- Saturated suction temperature
- Saturated condensing temperature
- Suction temperature
- Discharge temperature
- % of compressors active
- % of fans active
- Superheat

CAREL

- Subcooling
- Liquid temperature,
- % compressor request
- % fan request

And for the digital variables:

- High suction pressure alarm
- Low suction pressure alarm
- High condensing pressure alarm
- Sign of life
- Prevent active

Each generic function can be associated with a unit of measure and a description. Below is a description of the operation of four types of generic functions.

Stages

pRack PR100 can manage up to 5 stage functions, with either direct or reverse operation. In both cases, a set point and a differential can be set; the operation of the corresponding output is shown in the figure for both cases:

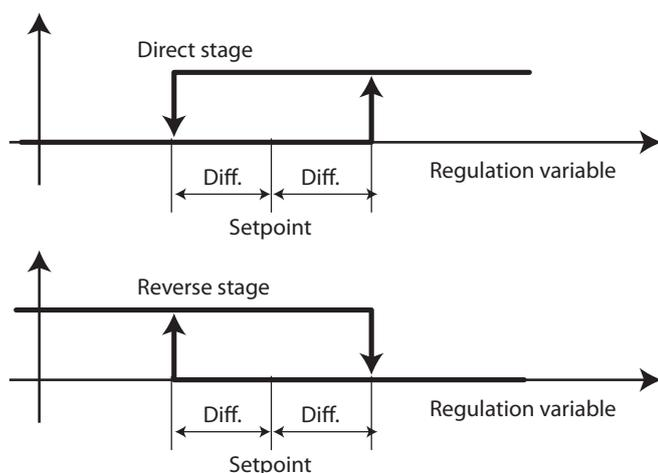

Fig. 6.aj

If an enabling variable has been set, the corresponding output is active if the enabling is also active.

For each stage, a high alarm threshold and a low alarm threshold can be set, and are absolute. For each alarm, the activation delay and priority can be set. See chapter 8 for details on the alarms.

One example of using the generic stage functions may be activation of the fans on the room units based on the temperature.

Modulation

pRack PR100 can manage up to 2 modulation functions, with either direct or reverse operation.

In both cases, a set point and a differential can be set; the operation of the corresponding output is shown in the figure for direct mode, with the cut-off function also enabled:

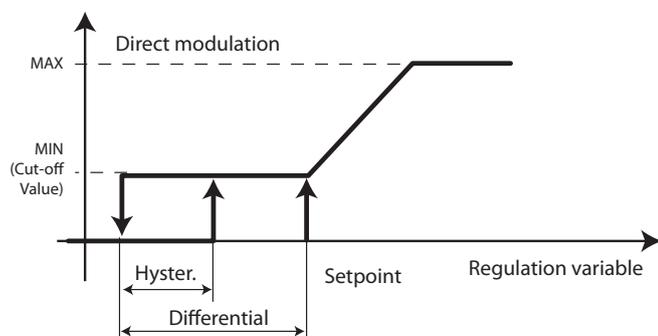

Fig. 6.ak

If an enabling variable has been set, the corresponding output is active if the enabling is also active.

For each modulation, a high alarm threshold and a low alarm threshold can be set, and are absolute. For each alarm, the activation delay and priority can be set. See chapter 8 for details on the alarms.

For modulation a minimum and maximum value can also be set for the output, and the cut-off function can be enabled, with operation as shown in the previous figure.

Alarms

pRack PR100 can manage up to 2 alarm functions, with settable digital variable to be monitored, activation delay, priority and description.

Each generic function can be associated with a digital output for the activation of external devices when the alarm is activated.

One example of using the generic alarm functions involves detecting gas leaks.

Scheduler

pRack PR100 can manage a generic scheduler that activates a digital output at certain time bands.

Up to 4 daily time bands can be set for each day of the week, in addition operation of the generic scheduler can be linked to the common scheduler, and consequently the output activated based on:

- summer/winter
- up to 5 closing periods
- up to 10 special days

See paragraph 6.7.2 for details on the time bands.

6.6.5 ChillBooster

pRack PR100 can control the Carel ChillBooster, device used for evaporative cooling of the air that flows through the condenser.

ChillBooster can be enabled and the related parameters set in main menu branch E.g.

ChillBooster is activated when two conditions exist:

- the outside temperature exceeds a set threshold
- the fan control request is at the maximum for at least a settable number of minutes

The maximum request time starts counting again whenever the request decreases, therefore the request must remain at the maximum for at least the set time. Activation ends when the request falls below a set threshold.

pRack PR100 can manage an alarm digital input from ChillBooster, the effect of which is to deactivate the device. For details see Chapter 8.

As the number of operating hours of ChillBooster is critical as regards formation of scale on the condenser, pRack PR100 can manage the operating hour threshold, which should be set to 200 hours.

Hygiene procedure

To avoid water stagnation in the pipes, a hygiene procedure can be enabled that activates ChillBooster every day for a set time, if the outside temperature is greater than a threshold.

Note: if the outside temperature probe is not configured or is configured but is not working, ChillBooster operates based solely on the control request, and the hygiene procedure can still be activated. The only difference between probe not configured and probe not working concerns the ChillBooster operating without temperature probe alarm, which is only generated when the probe is configured but not working.

ChillBooster as the first stage in high pressure prevention

ChillBooster can be used to prevent high condensing pressure.

The parameters relating to this function can be set in branch G.b.a/G.b.b in the main menu, after having enabled the ChillBooster function.

For details on the prevent function see paragraph 8.3.3.

Operation of ChillBooster as the first stage in high pressure prevention is similar to the heat recovery function described in paragraph 6.6.3.

The function must be enabled and an offset must be set in relation to the prevent threshold, while the differential is the same as set for the prevent function.

6.6.6 Double line synchronisation (DSS)

pRack PR100 can manage, for two line configurations, several synchronisation functions between the two lines:

- Disable simultaneous compressors starts
- Force the medium temperature line on if the low temperature line is activated
- Shutdown the low temperature line if the medium temperature line has a serious alarm

The three DSS functions can be enabled independently and are useful for booster or CO2 cascade system configurations:

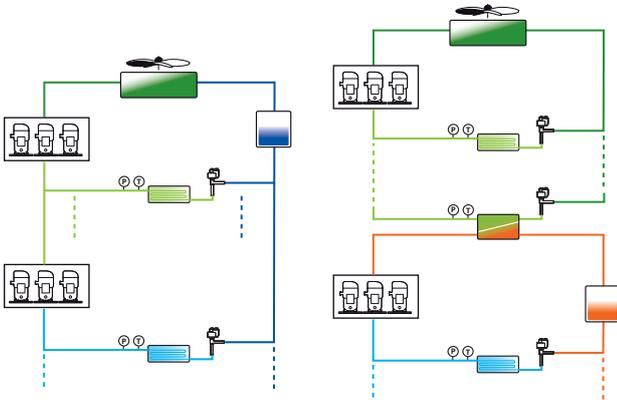

Fig. 6.al

Important: in the pRack PR100 software assumes that the medium temperature line is line L1, while the low temperature line is line L2. DSS can be enabled and the related parameters set in main menu branch E.h.

Disable simultaneous starts

Disabling simultaneous compressor starts may be useful for all system configurations with two separate lines and in cascade system configurations.

The function to avoid simultaneous starts can be enabled, setting a delay time between the starts of compressors on different lines.

Forcing the medium temperature line

Forcing the medium temperature line may be useful for cascade system configurations and involves, once enabled, forcing at least one compressor on medium temperature line L1 to start at minimum capacity, if at least one compressor on low temperature line L2 is running. This means that before the low temperature line starts, the DSS function forces at least one of the compressors on medium temperature line L1 to start. The low temperature line L2 thus has higher priority than the control request for medium temperature line L1.

Shutdown the low temperature line

The low temperature line is shutdown by the DSS function if a serious alarm is activated on the medium temperature line, or, in general, if the medium temperature line is OFF.

Note: in the event of pLAN network faults, DSS is disabled.

6.6.7 Unit of measure

pRack PR100 can manage two units of measure, the international system and Imperial.

Note: the temperature and pressure units of measure can be changed from °C, barg to °F, psig only during start-up; mixed configurations are not allowed, for example °F and barg.

6.6.8 Sign of life

pRack PR100 can manage a digital output acting as a sign of life, activated when pRack PR100 is powered up.

This output remains active while the controller is working correctly and highlights any hardware faults.

The Signal can be configured in main menu branch B.a.c.

6.6.9 Liquid non-return

pRack PR100 can manage a digital output with the meaning of liquid non-return. This normally active output is deactivated when all the compressors are off and no compressor can be started due to alarms or time settings, despite the control request, or when the unit is OFF. As soon as at least one compressor is enabled to start, the output is deactivated, allowing management of a liquid non-return valve. The function can be configured in main menu branch C.a.g/C.b.g.

6.6.10 Interaction with pLoads

pRack PR100 can interact with the pLoads controller, which manages power using a load cut-off function.

Interaction can be enabled and the related parameters set from main menu branch C.a.d and C.b.d.

Interaction between pRack pR100 and pLoads uses digital inputs or the supervisor. The digital inputs have higher priority, therefore if a digital input is not active, the corresponding action is not produced even if requested by the supervisor.

Two of the free digital inputs on pRack pR100 can be configured for connection to two pLoads outputs, with each input being assigned one of the following actions:

- No action. Activation of the digital input has no influence on control.
- Capacity limited to the current value. Activation of the digital input limits the maximum control request; capacity can be reduced from this value by the controller, but cannot exceed the current value at the moment the digital input was activated for the entire time it remains active, as shown in the figure:

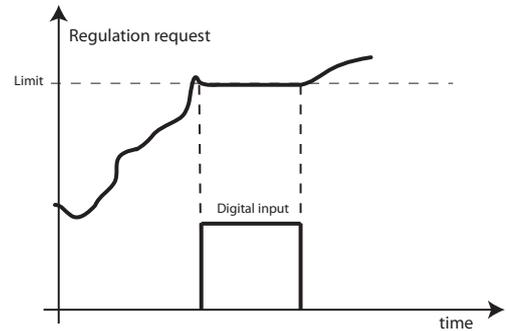

Fig. 6.am

- Capacity limited to a % value, settable by parameter. As in the previous case, the control request is limited at the top end, however to a fixed value set by parameter.
- Decrease capacity by a % value, settable by parameter. Activation of the digital input reduces the control request by a fixed value set by parameter, as shown in the figure:

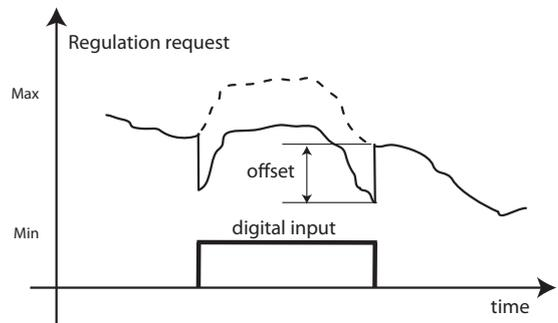

Fig. 6.an

By suitably setting this parameter based on system configuration, one compressor can be shut down; for example if there are three compressors, by setting the decrease to 33%, activation of the input stops one of the three compressors. Compressor shutdown and restart respect the safety times.

The digital inputs configured are common to both lines, while for each line a different action can be associated with the same digital input.

In any case, the previous actions do not interfere with the pRack pR100 safety features, which always have priority over the actions set from digital input.

Moreover, a suction pressure safety threshold has been introduced, therefore the actions associated with the inputs are only enabled if the pressure does not exceed this threshold (settable by parameter). After the pLoads action has been disabled, it is necessary that the suction pressure returns below the safety threshold for a setted time (higher than 30 s), before restoring the interaction between the two devices, so to the regulation can be stabilize.

6.6.11 Power consumption

pRack PR100 can calculate power consumption for the current day and the previous day.

The calculation can be enabled and the related parameters set from main menu branch C.a.d and C.b.d.

To calculate power consumption, the current draw is measured via an analogue input, while the type of load, rated voltage and displacement can be set by parameter.

The calculation starts at 00:00 every day and continues until 24:00, when the value from the previous day is overwritten with the new calculated value.

The supervisory system can use the two values, current day's consumption and previous day's consumption, for power consumption analysis.

6.7 Settings

6.7.1 Clock

pRack PR100 features an internal clock with backup battery that keeps the time and date for all related functions (see Chapter 2 for details relating to the hardware).

The date on pRack PR100 can be set as follows:

- day, month, year (dd/mm/yy)
- month, day, year (mm/dd/yy)
- year, month, day (yy/mm/dd)

The current date and time can be set, the day of the week corresponding to set date displayed, plus changeover to daylight saving can be enabled by setting the changeover date and the deviation.

The related parameters can be set during start-up or in main menu branch F.a.

 **Note:** the date and time are managed on pRack boards with addresses 1 and 2; on power-up and whenever the pLAN network is reconnected, the software on pRack synchronises the settings on board 2, sending the date and time set on board 1.

If the clock card is not operating, an alarm is generated and the functions relating to the time bands described in the following paragraph are not available.

6.7.2 Time bands

pRack PR100 allows the operating seasons, the closing periods and weekends to only be set once, and consequently these are common to all the system functions.

As well as these settings, each function can be associated with a weekly scheduler, setting up to 4 different daily activation bands for each day of the week. For each time band, the start and end time can be set and settings made can be copied to the others days of the week.

The priority of the schedulers, from lowest to highest, is:

- weekly scheduler
- closing periods
- special days

For example, if the weekly scheduler requires activation of a function, yet a closing period is in progress, and requires deactivation of the same function, then the function is deactivated.

The following functions allow the setting of time bands:

- Split-condenser: the function is active only based on the operating seasons, and consequently special days, closing periods and daily time bands are ignored.
- Silencer: the function is only active with daily time bands, there is no link to operating seasons, special days and closing periods
- Heat recovery: the function is active with daily time bands, special days and closing periods, no link to operating seasons. The link to the general scheduler can be disabled, considering the time bands only.
- Set point compensation: active with operating seasons, special days, closing periods and daily time bands (two different offsets).
- Generic functions: the generic scheduling function is active with the operating seasons, special days, closing periods and daily time bands. Operation of the generic functions can be separated from the generic scheduler, considering the daily time bands only.

For details on the functions that use time bands, see the corresponding paragraphs.

6.8 Managing the default values

pRack PR100 can manage two different sets of default values:

- user defaults
- Carel defaults

The two functions can be activated in main menu branch I.d.



Important: after having reset the default values, the pRack PR100 board need to be switched off and on again.

6.8.1 Saving and resetting the user default values

pRack PR100 can save the exact configuration set by the user inside the instrument, allowing it to be recalled at any time.

All the set values are saved, therefore loading user defaults restores the exact same conditions that the pRack PR100 controller was in when the data were saved.



Note: only one user default configuration can be saved, therefore when the data is next saved, this overwrites the previous data.



Important:

- the Carel default reset procedure totally deletes the pRack PR100 permanent memory, and consequently is an irreversible operation;
- the user values cannot be reset after updating the software on the pRack PR100, nonetheless see Chapter 10 for details on how to save the parameters for versions different of the software.

6.8.2 Resetting the Carel default values

The Carel default values are shown in the Parameters table in Chapter 7.

The values pre-set by Carel can be installed at any time, restoring the pRack PR100 default settings, and requiring the startup procedure described in Chapter 4 to be repeated.



Important: the Carel default reset procedure totally deletes the pRack PR100 permanent memory, and consequently is an irreversible operation; nonetheless, the user settings can still be restored if these have already been saved. Given that pRack PR100, following the installation of the Carel default values requires the startup procedure to be repeated, select the first pre-configuration and then restore the user defaults.



Note: to complete a new configuration procedure as described in Chapter 4, first restore the Carel default values.

7. PARAMETERS TABLE



“Mask index”: indicates the unique address of each screen and consequently the path needed to reach the parameters available on this screen; for example, to reach the parameters corresponding to the suction pressure probe with mask index Bab01, proceed as follows:



Main menu B. In./Out. → a. Status → b. Analog. in.

Below is the table of the parameters that can be displayed on the terminal. The values indicated with ‘---’ are not Significant or are not set, while the values indicated with ‘...’ may vary according to the configuration, with the possible options visible on the user terminal. A row of ‘...’ means that there are a series of parameters similar to the previous ones.



Note: Not all the screens and parameters shown in the table are always visible or can be set, the screens and parameters that are visible or can be set depend on the configuration and the access level.

Mask index	Display description	Description	Default	UOM	Values	
Main screen						
Main screen for single suction line and single condenser line (display only)	---	Hours and minutes	---	---	---	
	---	Date	---	---	---	
	Suction	Suction pressure or temperature	---	---	... (**)	
	Condensing	Condensing pressure or temperature	---	---	... (**)	
	Superheat	Superheat	---	---	... (**)	
	Suct.temp.	Suction temperature	---	---	... (**)	
	Disch.temp.	Discharge temperature	---	---	... (**)	
	---	Unit status (with unit OFF)	---	---	Unit OFF from alarm Unit OFF from blackout Unit OFF from supervisor Unit OFF by default Unit OFF by DIN Unit Off from keypad Unit OFF by manual op.	
	---	Number of compressors on (with unit ON)	---	---	0...12	
	---	Compressor activation percentage (with unit ON)	---	%	0...100	
	---	Number of fans on (with unit ON)	---	---	0...16	
	---	Fan activation percentage (with unit ON)	---	%	0...100	
	Main screen for double suction line and double condenser line, separate screens for each line (display only)	---	Hours and minutes	---	---	---
		---	Date	---	---	---
L1-Suction		Suction pressure or temperature (line 1)	---	---	... (**)	
L1-Condens.		Condensing pressure or temperature (line 1)	---	---	... (**)	
L1-Superheat		Superheat (line 1)	---	---	... (**)	
L1-Suct.temp.		Suction temperature (line 1)	---	---	... (**)	
L1-Disch.temp		Discharge temperature (line 1)	---	---	... (**)	
---		Unit status (with unit OFF)	---	---	See values on screen for single line	
---		Number of compressors on (with unit ON, line 1)	---	---	0...12	
---		Compressor activation percentage (with unit ON, line 1)	---	%	0...100	
---		Number of fans on (with unit ON, line 1)	---	---	0...16	
---		Fan activation percentage (with unit ON, line 1)	---	%	0...100	
L2-Suction		Suction pressure or temperature (line 2)	---	---	... (**)	
L2-Condens.		Condensing pressure or temperature (line 2)	---	---	... (**)	
L2-Superheat		Superheat (line 2)	---	---	... (**)	
L2-Suct.temp.		Suction temperature (line 2)	---	---	... (**)	
L2-Disch.temp		Discharge temperature (line 2)	---	---	... (**)	
---		Unit status (with unit OFF)	---	---	See values on screen for single line	
---		Number of compressors on (with unit ON, line 2)	---	---	0...12	
---		Compressor activation percentage (with unit ON, line 2)	---	%	0...100	
---	Number of fans on (with unit ON, line 2)	---	---	0...16		
---	Fan activation percentage (with unit ON, line 2)	---	%	0...100		
Main screen for double suction line and double condenser line, same screen for both lines (display only)	---	Hours and minutes	---	---	---	
	---	Date	---	---	---	
	L1-Suction	Suction pressure or temperature (line 1)	---	---	... (**)	
	L1-Condens.	Condensing pressure or temperature (line 1)	---	---	... (**)	
	L2-Suction	Suction pressure or temperature (line 2)	---	---	... (**)	
	L2-Condens.	Condensing pressure or temperature (line 2)	---	---	... (**)	
	L1-Suct.temp.	Suction temperature (line 1)	---	---	... (**)	
	L1-Superheat Condensing	Superheat (line 1)	---	---	... (**)	
	L2-Suct.temp.	Suction temperature (line 2)	---	---	... (**)	
	L2-Superheat	Superheat (line 2)	---	---	... (**)	
	L1-Disch.temp	Discharge temperature (line 1)	---	---	... (**)	
	L2-Disch.temp	Discharge temperature (line 2)	---	---	... (**)	
	---	Unit status (with unit OFF)	---	---	See values on screen for single line	
	---	Compressor activation percentage (with unit ON, line 1)	---	%	0...100	
---	Compressor activation percentage (with unit ON, line 2)	---	%	0...100		
---	Fan activation percentage (with unit ON, line 1)	---	%	0...100		
---	Fan activation percentage (with unit ON, line 2)	---	%	0...100		
Main screen for double suction line and single condenser line, (display only)	---	Hours and minutes	---	---	---	
	Suction:	Date	---	---	---	
	L1	Suction pressure or temperature (line 1)	---	---	... (**)	
	L2	Suction pressure or temperature (line 2)	---	---	... (**)	
	Condensing	Condensing pressure or temperature	---	---	... (**)	
	L1-Suct.temp.	Suction temperature (line 1)	---	---	... (**)	
	L1-Disch.temp	Discharge temperature (line 1)	---	---	... (**)	
	L1-Superheat	Superheat (line 1)	---	---	... (**)	
	L2-Suct.temp.	Suction temperature (line 2)	---	---	... (**)	
	L2-Disch.temp	Discharge temperature (line 2)	---	---	... (**)	
	L2-Superheat	Superheat (line 2)	---	---	... (**)	
	---	Unit status (with unit OFF)	---	---	See values on screen for single line	
	---	Compressor activation percentage (with unit ON, line 1)	---	%	0...100	
	---	Compressor activation percentage (with unit ON, line 2)	---	%	0...100	
---	Fan activation percentage (with unit ON, line 1)	---	%	0...100		

Mask index	Display description	Description	Default	UOM	Values
A. Unit status					
Aa01 (display only)	Pressure	Suction pressure (line 1)	--- (**)
	Sat.temp.	Saturated suction temperature (line 1)	--- (**)
	Act.setpoint	Effective set point for pressure control (with compensation applied, line 1)	... (**) (**)
Aa02 (display only)	Differential	Control differential for pressure control (line 1)	... (**) (**)
	Pressure	Suction pressure (line 1)	--- (**)
	Sat.temp.	Saturated suction temperature (line 1)	--- (**)
Aa03 (display only)	Act.setpoint	Effective set point for temperature control (with compensation applied, line 1)	... (**) (**)
	Differential	Control differential for temperature control (line 1)	... (**) (**)
	Actual/req.	Capacity delivered/capacity required for suction line (line 1)	---	%	0/0 ...100/100
	Reg.status	Control status (according to the type of control set, line 1)	---	---	Stop Increases Decrease Standby Operating Timings Alarms
Aa04 (display only)	Reg.type	Compressor control type (line 1)	Neutral zone	---	Proportional band Neutral zone
	Setpoint	Effective suction pressure set point (with compensation applied, line 1)	... (**) (**)
	C01, C02, ...C12	Time remaining to next compressor start (line 1)	---	s	0...32000
	C01	Capacity delivered by compressor 1 on line 1 (a "!" to the right of the value means that some form of compressor capacity override is active, e.g. times, alarms, start-up procedure)	---	%	0...100
Aa05 (display only)	---
	C12	Capacity delivered by compressor 12 (line 1)	---	%	0...100
	Temperature	Suction temperature (line 1)	--- (**)
Aa11 (display only)	Superheat	Superheat (line 1)	--- (**)
	Disch.1	Discharge temperature, compressor 1 (line 1)	--- (**)
Aa13 (display only)	---
	Disch.6	Discharge temperature, compressor 6 (line 1)	--- (**)
Aa15 (display only)	Liq.inj.1: DO	Number of digital output associated and status of liquid injection/ economizer (*) compressor 1 (line 1)	---	...	0...29 ON / OFF
	---
Aa16 (display only)	Liq.inj.6: DO	Number of digital output associated and status of liquid injection/ economizer (*) compressor 6 (line 1)	---	...	0...29 ON / OFF
	Discharge temperature	Digital ScrollTM compressor discharge temperature (line 1)	--- (**)
	Cap.reduction	Digital ScrollTM compressor capacity reduction in progress (line 1)	---	...	NO / YES
	Oil sump temp.	Digital ScrollTM compressor oil sump temperature (line 1)	--- (**)
Aa20 (display only)	Oil status	Digital ScrollTM compressor oil dilution status (line 1)	---	---	Ok Dilute
	Status	Digital ScrollTM compressor operating status (line 1)	---	---	Off Start up On Alarm Off by time On by time Mod. manual In pump down
	Countdown	Digital ScrollTM compressor time count (line 1)	---	s	0...999
	Compr.	Digital ScrollTM compressor status (line 1)	---	---	OFF ON
Aa21 (display only)	Valve	Digital ScrollTM valve status (line 1)	---	---	OFF ON
	Requested cap.	Digital ScrollTM compressor capacity required (line 1)	---	%	0...100
	Current capac.	Digital ScrollTM compressor effective capacity (line 1)	---	%	0...100
	Pressure	Condensing pressure (line 1)	--- (**)
Aa22 (display only)	Sat.temp.	Saturated condensing temperature (line 1)	--- (**)
	Act.setpoint	Effective set point for pressure control (with compensation applied, line 1)	... (**) (**)
	Differential	Control differential for pressure control (line 1)	... (**) (**)
Aa23 (display only)	Pressure	Condensing pressure (line 1)	--- (**)
	Sat.temp.	Saturated condensing temperature (line 1)	--- (**)
	Act.setpoint	Effective set point for temperature control (with compensation applied, line 1)	... (**) (**)
Aa24 (display only)	Differential	Control differential for temperature control (line 1)	... (**) (**)
	Actual/req.	Capacity delivered/capacity required for condenser line (line 1)	---	%	0/0 ...100/100
	Status	Control status (according to the type of control set, line 1)	---	---	Stop Increase Decrease Stand-by Operating Timings Alarms
	Reg.type	Condenser control type (line 1)	Neutral zone	---	Proportional band Neutral zone
Aa25 (display only)	Setpoint	Condenser control effective set point (with compensation applied, line 1)	... (**) (**)
	F1	Power output of fan 1 on line 1 (a "!" to the right of the value means that some form of power override is active)	---	%	0...100
Aa26 (display only)	---
	F8	Power output of fan 8 on line 1 (a "!" to the right of the value means that some form of power override is active)	---	%	0...100
Aa27 (display only)	---
	F9	Power output of fan 9 on line 1 (a "!" to the right of the value means that some form of power override is active)	---	%	0...100
Aa28 (display only)	---
	F16	Power output of fan 16 on line 1 (a "!" to the right of the value means that some form of power override is active)	---	%	0...100
Aa31 (display only)	Discharge temperature	Discharge temperature (line 1)	--- (**)
	External temperature	Outside temperature (line 1)	--- (**)
	Pressure	Suction pressure (line 2)	--- (**)
Aa32 (display only)	Sat.temp.	Saturated suction temperature (line 2)	--- (**)
	Act.setpoint	Effective set point for pressure control (with compensation applied, line 2)	... (**) (**)
	Differential	Control differential for pressure control (line 2)	... (**) (**)
Aa33 (display only)	Pressure	Suction pressure (line 2)	--- (**)
	Sat.temp.	Saturated suction temperature (line 2)	--- (**)
	Act.setpoint	Effective set point for temperature control (with compensation applied, line 2)	... (**) (**)
Aa34 (display only)	Differential	Control differential for temperature control (line 2)	... (**) (**)

Mask index	Display description	Description	Default	UOM	Values
Aa33 (display only)	Actual/req.	Capacity delivered/capacity required for suction line (line 2)	---	%	0/0 ... 100/100
	Status	Control status (according to the type of control set, line 2)	---	---	Stop Increase Decrease Stand-by Operating Timings Alarms
	Reg.type	Compressor control type (line 2)	Neutral zone	---	Proportional band Neutral zone
Aa34 (display only)	Setpoint	Effective suction pressure set point (with compensation applied, line 2)	... (**) (**)
	C01, C02, ...C12	Time remaining to next compressor start (line 2)	---	s	0...32000
	C01	Capacity delivered by compressor 1 on line 2 (a "!" to the right of the value means that some form of compressor capacity override is active, e.g. times, alarms, start-up procedure)	---	%	0...100
Aa05 (display only)	C12	Capacity delivered by compressor 12 (line 2)	---	%	0...100
	Temperature	Suction temperature (line 2)	--- (**)
Aa41 (display only)	Superheat	Superheat (line 2)	--- (**)
	Disch.1	Discharge temperature, compressor 1 (line 2)	--- (**)
Aa43 (display only)	Disch.6	Discharge temperature, compressor 6 (line 2)	--- (**)
	Liq.inj.1: DO	Number of digital output associated and status liquid injection compr. 1 (line 2)	---	...	0...29 ON / OFF
Aa45 (display only)	Liq.inj.6: DO	Number of digital output associated and status liquid injection compr. 6 (line 2)	---	...	0...29 ON / OFF
	Discharge temperature	Digital ScrollTM compressor discharge temperature (line 2)	--- (**)
Aa46 (display only)	Cap.reduction	Digital ScrollTM compressor capacity reduction in progress (line 2)	---	---	NO / YES
	Oil sump temp.	Digital ScrollTM compressor oil sump temperature (line 2)	--- (**)
Aa50 (display only)	Oil status	Digital ScrollTM compressor oil dilution status (line 2)	---	---	Ok Dilute
	Status	Digital ScrollTM compressor operating status (line 2)	---	---	Off Start up On Alarm Off by time On by time Manual mod. In pump down
Aa51 (display only)	Countdown	Digital ScrollTM compressor time count (line 2)	---	s	0...999
	Compr.	Digital ScrollTM compressor status (line 2)	---	---	OFF / ON
Aa52 (display only)	Valve	Digital ScrollTM valve status (line 2)	---	---	OFF / ON
	Requested cap.	Digital ScrollTM compressor capacity required (line 2)	---	%	0...100
Aa53 (display only)	Current capac.	Digital ScrollTM compressor effective capacity (line 2)	---	%	0...100
	Pressure	Condensing pressure (line 2)	--- (**)
Aa54 (display only)	Sat.temp.	Saturated condensing temperature (line 2)	--- (**)
	Act.setpoint	Effective set point for pressure control (with compensation applied, line 2)	... (**) (**)
Aa55 (display only)	Differential	Control differential for pressure control (line 2)	... (**) (**)
	Pressure	Condensing pressure (line 2)	--- (**)
Aa60 (display only)	Sat.temp.	Saturated condensing temperature (line 2)	--- (**)
	Act.setpoint	Effective set point for temperature control (with compensation applied, line 2)	... (**) (**)
Aa61 (display only)	Differential	Control differential for temperature control (line 2)	... (**) (**)
	Actual/req.	Capacity delivered/capacity required for condenser line (line 2)	---	%	0/0 ... 100/100
Aa52 (display only)	Reg.status	Control status (according to the type of control set, line 2)	---	---	Stop Increase Decrease Stand-by Operating Timings Alarms
	Reg.type	Condenser control type (line 2)	Neutral zone	---	Proportional band Neutral zone
Aa53 (display only)	Setpoint	Condenser control effective set point (with compensation applied, line 2)	... (**) (**)
	F1	Power output of fan 1 on line 2 (a "!" to the right of the value means that some form of power override is active)	---	%	0...100
Aa54 (display only)	F8	Power output of fan 8 on line 2 (a "!" to the right of the value means that some form of power override is active)	---	%	0...100
	F9	Power output of fan 9 on line 2 (a "!" to the right of the value means that some form of power override is active)	---	%	0...100
Aa55 (display only)	F16	Power output of fan 16 on line 2 (a "!" to the right of the value means that some form of power override is active)	---	%	0...100
	Discharge temperature	Discharge temperature (line 2)	--- (**)
Aa60 (display only)	External temperature	Outside temperature (line 2)	--- (**)
	Status,curr.	Effective status of screw compressor 1 with stepped modulation	---	---	Off Start up Stage1 Stage 2 Stage 3 Stage 4
Aa61 (display only)	Status, req.	Status required for the screw compressor 1 with stepped modulation	---	---	Off Start up Stage1 Stage 2 Stage 3 Stage 4
	Minimum on time	Countdown for minimum on time screw comp. 1 with stepped modulation	---	s	0...999
Aa61 (display only)	Min.off/starts	Countdown for minimum off time or wait between successive starts screw comp. 1 with stepped modulation	---	s	0...999
	Next step	Countdown for next step activation screw comp. 1 with stepped modulation	---	s	0...999
Aa61 (display only)	Status	Effective status of screw compressor 1 with continuous capacity modulation	---	---	Off Start up Norm. operating Shut down
	Shut down countd.	Screw comp. 1 off time with continuous capacity modulation	---	s	0...999
Aa61 (display only)	Max.pow.countdown	Countdown for minimum off time or wait between successive starts screw comp. 1 with continuous capacity modulation	---	s	0...999
	Min.on countdown	Countdown to start screw comp. 1 with continuous capacity modulation	---	s	0...999

Mask index	Display description	Description	Default	UOM	Values
Aa62 (display only)	Status,curr.	Effective status of screw compressor 2	---	---	Off Start up Stage1 Stage 2 Stage 3 Stage 4
	Status, req.	Status required for the screw compressor 2	---	---	Off Start up Stage1 Stage 2 Stage 3 Stage 4
	Minimum on time	Countdown for minimum on time screw comp. 2	---	s	0...999
	Min.off/starts	Countdown for minim. off time or wait between successive starts screw comp. 2	---	s	0...999
	Next step	Countdown for next step activation screw comp. 2	---	s	0...999
Aa70 (display only)	Zone	Envelope zone for screw compressor 1	---	---	0...14
	Max admit.time	Maximum duration allowed in the zone	---	min	0...999
	Countdown	Countdown	---	s	0...32000
	Max admit.power	Maximum capacity allowed in the zone	---	%	0...100
Aa71 (display only)	Startup status	Start-up status for screw compressor 1	---	---	Off Compressor on Intermediate interval Final interval Compressor off RestartAlarm
	N° startup restart	Number of restarts	---	---	0...99
Aa72 (display only)	Err.code	Type of error in envelope definition	---	---	No error Env. def. inconsist..
	Al.code	Type of alarm activated	---	---	No Alarm Max time elapsed Zone not allowed Max. no. of restarts
	Envel.def.error code	Type of error in selection of predefined envelope	---	---	No error Comp. not supported Gas type not allowed
	Reg.var.	Control variable value for generic stage function 1	---	---	... (**)
Aaan (display only)	Enable	Enabling variable status for generic stage function 1	---	---	Not active active
	Setpoint	Control set point for generic stage function 1	---	---	... (**)
	Differential	Control differential for generic stage function 1	---	---	... (**)
	Mode	Control mode for generic stage function 1 (direct or reverse)	---	---	D, R
	Status	Status of generic stage function 1	---	---	Not active / Active
	---	---	...
Aaar (display only)	Reg.var.	Control variable value for the generic stage function 5	---	---	... (**)
	Enable	Enabling variable status for the generic stage function 5	---	---	Not active / Active
	Setpoint	Control set point for the generic stage function 5	---	---	... (**)
	Differential	Control differential for the generic stage function 5	---	---	... (**)
	Mode	Control mode for the generic stage function 5 (direct or reverse)	---	---	D, R
	Status	Status of generic stage function 5	---	---	Not active / Active
Aaas (display only)	Reg.variable	Control variable value for generic modulating function 1	---	---	... (**)
	Enable	Enabling variable status for generic modulating function 1	---	---	Not active / Active
	Setpoint	Control set point for generic modulating function 1	---	---	... (**)
	Differential	Control differential for generic modulating function 1	---	---	... (**)
	Mode	Control mode for generic modulating function 1 (direct or reverse)	---	---	D, R
	Status	Status of generic modulating function 1	---	%	0.0...100.0
Aaat (display only)	Reg.variable	Control variable value for generic modulating function 2	---	---	... (**)
	Enable	Enabling variable status for generic modulating function 2	---	---	Not active / Active
	Setpoint	Control set point for generic modulating function 2	---	---	... (**)
	Differential	Control differential for generic modulating function 2	---	---	... (**)
	Mode	Control mode for generic modulating function 2 (direct or reverse)	---	---	D, R
	Status	Status of generic modulating function 2	---	%	0.0...100.0
Aaau (display only)	Reg.variable	Control variable status for generic alarm function 1	---	---	Not active / Active
	Enable	Enabling variable status for generic alarm function 1	---	---	Not active / Active
	Type	Type of alarm for generic alarm function 1	---	---	Light / Serious
	Delay time	Control differential for generic alarm function 1	---	s	0...9999
	Status	Status of generic alarm function 1	---	---	Not active / Active
	---	---	...
Aaav (display only)	Reg.variable	Control variable status for generic alarm function 2	---	---	Not active / Active
	Enable	Enabling variable status for generic alarm function 2	---	---	Not active / Active
	Type	Type of alarm for generic alarm function 2	---	---	Light / Serious
	Delay time	Control differential for generic alarm function 2	---	s	0...9999
	Status	Status of generic alarm function 2	---	---	Not active / Active
	---	---	...
Aaaw (display only)	Weekday	Day of the week	---	---	Monday, ..., Sunday
	TB1: --:-- -> --:--	Enabling and definition of time band 1: start hour and minutes, end hour and minutes for the generic scheduling function	---	---	...
	---	---	...
	TB4: --:-- -> --:--	Enabling and definition of time band 4: start hour and minutes, end hour and minutes for the generic scheduling function	---	---	...
Aaax (display only)	Status	Status of generic scheduling function	---	---	Not active / Active
	Status	Status of heat recovery function (line 1)	---	---	OFF / ON
	Heat recl. temp.	Heat recovery temperature (line 1)	---	---	... (**)
	An.OUT modul.	Status of modulating heat recovery valve output (line 1)	---	---	0.0...100.0
	HR Prevent	Status of prevention via heat recovery (line 1)	---	---	OFF / ON
	Status	Status of heat recovery function (line 2)	---	---	OFF / ON
Aaay (display only)	Heat recl. temp.	Heat recovery temperature (line 2)	---	---	... (**)
	An.OUT modul.	Status of modulating heat recovery valve output (line 2)	---	---	0.0...100.0
	HR Prevent	Status of prevention via heat recovery (line 2)	---	---	OFF / ON
	Status	Status of ChillBooster device (line 1)	---	---	OFF / ON
Aaaz (display only)	Ext.temp.	Outside temperature (line 1)	---	---	... (**)
	Ext.temp.thr.	ChillBooster activation threshold (line 1)	---	---	... (**)
	Time fan 100%	Number of minutes elapsed with fans at 100/number of min. allowed (line 1)	---	min	0...999/0...999
	Status	Status of ChillBooster device (line 2)	---	---	OFF / ON
Aaa1 (display only)	Ext.temp.	Outside temperature (line 2)	---	---	... (**)
	Ext.temp.thr.	ChillBooster activation threshold (line 2)	---	---	... (**)
	Time fan 100%	Number of minutes elapsed with fans at 100/number of minutes allowed (line 1)	---	min	0...999/0...999
	Status	Status of ChillBooster device (line 2)	---	---	OFF / ON

Mask index	Display description	Description	Default	UOM	Values	
Aaa2 (display only)	Cond.temp.	Saturated condensing temperature (line 1)	--- (**)	
	Liquid Temp.	Liquid temperature (line 1)	--- (**)	
	Subcooling	Subcooling (line 1)	--- (**)	
	Status	Status of subcooling function (line 1)	---	---	Open / Closed	
Aaa4 (display only)	Cond.temp.	Saturated condensing temperature (line 2)	--- (**)	
	Liquid Temp.	Liquid temperature (line 2)	--- (**)	
	Subcooling	Subcooling (line 2)	--- (**)	
	Status	Status of subcooling function (line 2)	---	---	Open / Closed	
Aaa4 (display only)	Action 1	Description and status of the reduced power consumption action associated with the first digital input from pLoads (line 1)	---	---	OFF / ON	
	Action 2	Description and status of the reduced power consumption action associated with the second digital input from pLoads (line 1)	---	---	OFF / ON	
Aaa5 (display only)	Action 1	Description and status of the reduced power consumption action associated with the first digital input from pLoads (line 2)	---	---	OFF / ON	
	Action 2	Description and status of the reduced power consumption action associated with the second digital input from pLoads (line 2)	---	---	OFF / ON	
Aaa6 (display only)	Current	Value read by the current sensor (line 1)	---	A	0 to 999.9	
	Inst. power	Instant power calculated (line 1)	---	kW	0 to 100	
	Power today	Power consumption during the current day (line 1)	---	kWh	0 to 32767	
	Previous User setp.	Power consumption during the previous day (line 1) User-defined set point for suction pressure control, proportional control (line 1)	---	kWh	0 to 32767 ... (**)	
Ab01 (display only)	Actual.setpoint	Effective set point for suction pressure control, proportional control (with compensation applied, line 1)	--- (**)	
	Diff.	Suction pressure control differential, proportional control (line 1)	--- (**)	
Ab02 (display only)	User setp.	User-defined set point for suction pressure control, proportional control (line 1)	--- (**)	
	Actual.setpoint	Effective set point for suction pressure control, proportional control (with compensation applied, line 1)	--- (**)	
	Neutral zone	Neutral zone for suction pressure control (line 1)	--- (**)	
	Incr.diff.	Increase differential for suction pressure control, neutral zone control (line 1)	--- (**)	
Ab03 (display only)	Decr.diff.	Decrease differential for suction pressure control, neutral zone control (line 1)	--- (**)	
	User setp.	User-defined set point for suction pressure control, proportional control (line 2)	--- (**)	
	Actual.setp.	Effective set point for suction pressure control, proportional control (with compensation applied, line 2)	--- (**)	
Ab04 (display only)	Diff.	Suction pressure control differential, proportional control (line 2)	--- (**)	
	User setp.	User-defined set point for suction pressure control, proportional control (line 2)	--- (**)	
	Actual.setp.	Effective set point for suction pressure control, proportional control (with compensation applied, line 2)	--- (**)	
	Neutral zone	Neutral zone for suction pressure control (line 2)	--- (**)	
Ab05 (display only)	Incr.diff.	Increase differential for suction pressure control, neutral zone control (line 2)	--- (**)	
	Decr.diff.	Decrease differential for suction pressure control, neutral zone control (line 2)	--- (**)	
	User setp.	User-defined set point for condensing pressure control, proportional control (line 1)	--- (**)	
	Actual.setp.	Effective set point for condensing pressure control, proportional control (with compensation applied, line 1)	--- (**)	
Ab06 (display only)	Diff.	Condensing pressure control differential, proportional control (line 1)	--- (**)	
	User setp.	User-defined set point for condensing pressure control, proportional control (line 1)	--- (**)	
	Actual.setp.	Effective set point for condensing pressure control, proportional control (with compensation applied, line 1)	--- (**)	
	Neutral zone	Neutral zone for condensing pressure control (line 1)	--- (**)	
Ab07 (display only)	Incr.diff.	Increase differential for the condensing pressure control, neutral zone control (line 1)	--- (**)	
	Decr.diff.	Decrease differential for the condensing pressure control, neutral zone control (line 1)	--- (**)	
	User setp.	User-defined set point for condensing pressure control, proportional control (line 2)	--- (**)	
	Actual.setp.	Effective set point for condensing pressure control, proportional control (with compensation applied, line 2)	--- (**)	
Ab08 (display only)	Diff.	Condensing pressure control differential, proportional control (line 2)	--- (**)	
	User setp.	User-defined set point for condensing pressure control, proportional control (line 2)	--- (**)	
	Actual.setp.	Effective set point for condensing pressure control, proportional control (with compensation applied, line 2)	--- (**)	
	Neutral zone	Neutral zone for condensing pressure control (line 2)	--- (**)	
Ab12	Incr.diff.	Increase differential for the condensing pressure control, neutral zone control (line 2)	--- (**)	
	Decr.diff.	Decrease differential for the condensing pressure control, neutral zone control (line 2)	--- (**)	
	Setpoint	Setpoint without compensation (suction line 1)	3,5 barg (**)	
Ab13	Setpoint	Setpoint without compensation (condenser line 1)	12,0 barg (**)	
Ab14	Setpoint	Setpoint without compensation (suction line 2)	3,5 barg (**)	
Ab15	Setpoint	Setpoint without compensation (condenser line 2)	12,0 barg (**)	
Ac01	Status	Unit status (display only)	Off from keypad	---	Waiting.. Unit On/ Off from alarm Off from blackout Off from BMS	Off by default Off by DIN Off from keypad Manual op. Prevent HP
	---	On-Off from keypad (line 1)	OFF	---	OFF / ON	
Ac02	L1:	Unit status (display only)	Off from keypad	---	...(See above Ac01)	
	L2:	On-Off from keypad (line 1)	OFF	---	OFF / ON	
	---	On-Off from keypad (line 2)	OFF	---	OFF / ON	

Mask index	Display description	Description	Default	UOM	Values
Ac03	Enable of unit OnOff	Enable unit On/Off from digit input (line 1)	NO	---	NO / YES
	By digit input				
	By supervisor	Enable unit On/Off from supervisor (line 1)	NO	---	NO / YES
Ac04	By black out	Enable unit On/Off from black out (line 1)	NO	---	NO / YES
	Unit on delay after blackout	System on delay after black out (line 1)	0	s	0...999
Ac06	Enable of unit OnOff	Enable unit On/Off from digit input (line 2)	NO	---	NO / YES
	By digit input				
	By supervisor	Enable unit On/Off from supervisor (line 2)	NO	---	NO / YES
Ac07	By black out	Enable unit On/Off from black out (line 2)	NO	---	NO / YES
	Unit on delay after blackout	System on delay after black out (line 2)	0	s	0...999

Mask index	Display Description	Description	Default	UOM	Values
------------	---------------------	-------------	---------	-----	--------

I/O B. Input. Output (the I/Os available depend on the selected configuration, the following are just some examples. For the complete list of I/O positions available see Appendix A.5)

Baa02	DI	Alarm 1 for compressor 1 DI position (line 1)	03	---	---, 01...18, B1...B10 (****)
	Status (display only)	Status of alarm 1 for compressor 1 DI (line 1)	---	---	Closed / Open
	Logic	Logic of alarm 1 for compressor 1 DI (line 1)	NC	---	NC / NO
	Function (display only)	Alarm 1 for compressor 1 function status (line 1)	---	---	Not active / Active
...
Bab01	---	Suction pressure probe position (line 1)	B1	---	---, B1...B10 (****)
	---	Suct pressure probe type (line 1)	4-20mA	---	---
	---	Suction pressure value (line 1)	---	---	0-1V- 0-10V- 4-20mA- 0-5V
	Upper value	Suct pressure maximum value (line 1)	7,0 barg	---	... (**)
	Lower value	Suct pressure minimum value (line 1)	-0,5 barg	---	... (**)
...	Calibration	Suction pressure probe adjustment (line 1)	0,0 barg	---	... (**)
...
Bac02	Line relay DO	Compressor 1 line DO position and status (On/Off) display (line 1)	---	---	---, 01...29 (****)
	Part winding DO/Star relay DO (*)	Compressor 1 part winding or star DO position and status (On/Off) display (line 1)	---	---	---, 01...29 (****)
	---/ Delta relay DO (*)	Compressor 1 delta DO position and status (On/Off) display (line 1)	---	---	---, 01...29 (****)
	Logic	DO logic to start compressor 1 (line 1)	NC	---	NC / NO
Bac03	DO	Compressor 1 unloader 1 DO position (line 1)	---	---	---, 01...29 (****)
	Status (display only)	Status for compressor 1 unloader 1 DO (line 1)	---	---	Closed / Open
	Logic	Logic for compressor 1 unloader 1 DO (line 1)	NO	---	NC / NO
...	Function (display only)	Compressor 1 unloader 1 function status (line 1)	---	---	Not active / Active
...
Bad01	AO	Compressor modulating device AO position (line 1)	0	---	---, 01...06 (****)
	Type (****)	Type of output, PWM / phase control for compressor modulating device (line 1)	FCS1*-CON-VONOFF	---	FCS1*-CONVONOFF FCS3*-CONV010"
	Status (display only)	Modulating device output value (line 1)	0	%	0.0 to 100.0
...
Bb01	Suction L1	Suction line 1 in manual mode	DIS	---	DIS / EN
	Suction L2	Suction line 2 in manual mode	DIS	---	DIS / EN
	Discharge L1	Condenser line 1 in manual mode	DIS	---	DIS / EN
	Discharge L2	Condenser line 2 in manual mode	DIS	---	DIS / EN
	Timeout	Manual mode duration after last key pressed	10	min	0...500
Bba02	Compressor 1 Force to	Manual stages request for compressor 1 (line 1)	OFF	---	OFF / ON 2 STAGES (*) 4 STAGES (*)

Bba16	Compressor 12 Force to	Manual stage request for compressor 12 (line 1)	OFF	---	OFF / ON 2 STAGES (*) 4 STAGES (*)
Bba17	Oil cool pump1 Force to	Manual operating status for oil cooling pump 1 (line 1)	OFF	---	OFF / ON
	Oil cool pump2 Force to	Manual operating status for oil cooling pump 2 (line 1)	OFF	---	OFF / ON
Bba18	Oil cool fan Force to	Manual operating status for oil cooling fan (line 1)	OFF	---	OFF / ON
Bba20	Compressor 1 Force to	Manual stage request for compressor 1 (line 2)	OFF	---	OFF / ON 2 STAGES (*) 4 STAGES (*)
...
Bba34	Compressor 12 Force to	Manual stage request for compressor 12 (line 2)	OFF	---	OFF / ON 2 STAGES (*) 4 STAGES (*)
Bba35	Oil cool pump1 Force to	Manual operating status for oil cooling pump 1 (line 2)	OFF	---	OFF / ON
	Oil cool pump2 Force to	Manual operating status for oil cooling pump 2 (line 2)	OFF	---	OFF / ON
Bba37	Oil cool fan Force to	Manual operating status for oil cooling fan (line 2)	OFF	---	OFF / ON
Bba38	Fan1 force	Manual operating status for fan 1 (line 1)	OFF	---	OFF / ON
...
Bba53	Fan16 force	Manual operating status for fan 16 (line 1)	OFF	---	OFF / ON
Bba54	Heat reclaim pump force	Manual operating status for heat recovery pump (line 1)	OFF	---	OFF / ON
Bba55	ChillBooster force	Manual operating status for ChillBooster (line 1)	OFF	---	OFF / ON
Bba57	Fan1 force	Manual operating status for fan 1 (line 2)	OFF	---	OFF / ON
...

Mask index	Display Description	Description	Default	UOM	Values
Bba72	Fan16 force	Manual operating status for fan 16 (line 2)	OFF	---	OFF / ON
Bba73	Heat reclaim pump force	Manual operating status for heat recovery pump (line 2)	OFF	---	OFF / ON
Bba74	ChillBooster force	Manual operating status for ChillBooster (line 2)	OFF	---	OFF / ON
Bbb05	Compressor 1 Force to	Manual continuous capacity request for compressor 1 (line 1)	0.0	%	0.0...100.0
Bbb06	Oil cool pump Force to	Manual request for oil cooling pump (line 1)	0.0	%	0.0...100.0
Bbb07	Compressor 1 Force to	Manual continuous capacity request for compressor 1 (line 2)	0.0	%	0.0...100.0
Bbb08	Oil cool pump Force to	Manual request for oil cooling pump (line 2)	0.0	%	0.0...100.0
Bbb09	Fan1 Force to	Manual continuous capacity request for fan 1 (line 1)	0.0	%	0.0...100.0
Bbb10	Heat reclaim pump force	Manual request for heat recovery pump (line 1)	0.0	%	0.0...100.0
Bbb11	Fan1 Force to	Manual continuous capacity request for fan 1 (line 2)	0.0	%	0.0...100.0
Bbb12	Heat reclaim pump force	Manual request for heat recovery pump (line 2)	0.0	%	v
Bc01	Test Dout Timeout	Enable DO test mode Test mode duration after last button pressed	NO 10	--- min	NO / YES 0...500
Bc02	Test Aout Timeout	Enable AO test mode Test mode duration after last button pressed	NO 10	--- min	NO / YES 0...500
Bca10	DO1	DO 1 logic for test DO 1 value for test	NO OFF	--- ---	NO / NC OFF / ON
...
Bca26	DO29	DO 29 logic for test DO 29 value for test	NO OFF	--- ---	NO / NC OFF / ON
Bcb10	AO1	AO 1 value for test	0.0	---	0.0...100.0
...
Bcb12	AO6	AO 6 value for test	0.0	---	0.0...100.0

Mask index	Display description	Description	Default	UOM	Values
------------	---------------------	-------------	---------	-----	--------

 C. Compressors(*) (The I/Os available depend on the selected configuration, the following are just some examples. For the complete list of I/O positions available see Appendix A.5)

Caa01	DI	Alarm 1 for compressor 1 DI position (line 1)	03	---	---,01...18,B1...B10(****)
	Status (display only)	Status of alarm 1 for compressor 1 DI (line 1)	---	---	Closed / Open
	Logic	Logic of alarm 1 for compressor 1 DI (line 1)	NC	---	NC / NO
	Function (display only)	Alarm 1 for compressor 1 function status (line 1)	---	---	Not active / Active
...
Caa08	Line relay DO	Compressor 1 part winding or star DO position and status (On/Off) display (line 1)	...	---	---,01...29(****)
	Part winding DO/Star relay DO (*)	Compressor 1 delta DO position and status (On/Off) display (line 1)	...	---	---,01...29(****)
	---/Delta relay DO (*)	Compressor 1 line DO position and status (On/Off) display (line 1)	...	---	---,01...29(****)
	Logic	DO logic to start compressor 1 (line 1)	NC	---	NC / NO
Caa09	DO	Unloader 1 for compressor 1 DO position (line 1)	...	---	---,01...29(****)
	Status (display only)	Status of unloader 1 for compressor 1 DI (line 1)	---	---	Closed / Open
	Logic	Logic of unloader 1 for compressor 1 DI (line 1)	NC	---	NC / NO
	Function (display only)	Unloader 1 for compressor 1 function status (line 1)	---	---	Not active / Active
...
Caa14	AO	Compressor modulating device AO position (line 1)	0	---	---,01...06(****)
	Type (****)	Type of output, PWM / phase ctrl for compressor modulating device (line 1)	FCS1*-CON-VONOFF	---	FCS1*-CONVONOFF FCS3*-CONV010*
	Status (display only)	Modulating device output value (line 1)	0	%	0.0...100.0
...
Caaal	---	Suction pressure probe position (line1)	B1	---	---,B1...B10(****)
	---	Suct pressure probe type (line 1)	4-20mA	---	---
	---	---	---	---	---
	---	Suction temperature value (line 1)	--- (**)
	Upper value	Suct pressure maximum limit (line 1)	7,0 barg (**)
	Lower value	Suct pressure minimum limit (line 1)	-0,5 barg (**)
	Calibration	Suction pressure probe adjustment (line 1)	0,0 barg (**)
...
Cab01	Regulation by	Compressor control by temperature or pressure (line 1)	PRESSURE	---	PRESSURE TEMPERATURE
	Regulation type	Compressor control type (line 1)	NEUTRAL ZONE	---	PROPORTIONAL BAND NEUTRAL ZONE
Cab02	Minimum	Compressor setpoint lower limit (line 1)	... (**) (**)
	Maximum	Compressor setpoint higher limit (line 1)	... (**) (**)
Cab03	Setpoint	Compressor setpoint (line 1)	... (**) (**)
Cab04/Cab6 (**)	Reg.type	Type for proportional control (line 1)	PROPORT.	---	PROPORTIONAL PROP.+INT.
	Integral time	Integral time for proportional control (line 1)	300	s	0...999
Cab05/Cab7 (**)	Differential	Differential for proportional control (line 1)	... (**) (**)
Cab08/Cab10 (**)	NZ diff.	Neutral zone control differential (line 1)	... (**) (**)
	Activ.diff.	Neutral zone control differential for device activation (line 1)	... (**) (**)
	Deact.diff.	Neutral zone control differential for device deactivation (line 1)	... (**) (**)

Mask index	Display description	Description	Default	UOM	Values
Cab09/Cab11 (**)	En.force off power	Enable capacity immediate decreasing to 0 (line 1)	NO	---	NO / YES
	Setp.for force off	Threshold for capacity decreasing to 0 (line 1)	... (**) (**)
Cab12	Power load to 100% min time	Minimum time to increase capacity request to 100%, Neutral zone control (suction line 1)	15	s	0...9999
	Power load to 100% max time	Maximum time to increase capacity request to 100%, Neutral zone control (suction line 1)	90	s	0...9999
Cab13	Power unload to 0% min time	Minimum time to decrease capacity request to 0%, Neutral zone control (suction line 1)	30	s	0...9999
	Power unload to 0% max time	Maximum time to decrease capacity request to 0%, Neutral zone control (suction line 1)	180	s	0...9999
Cac01	Working hours Compressor 1	Compressor 1 operating hours (line 1)	---	h	0...999999
	(Check in...)	Compressor 1 remaining operating hours (line 1)	...	h	0...999999
	Compressor 2	Compressor 2 operating hours (line 1)	---	h	0...999999
	(Check in...)	Compressor 2 remaining operating hours (line 1)	...	h	0...999999
...
Cac11	Working hours Compressor 11	Compressor 11 operating hours (line 1)	---	h	0...999999
	(Check in...)	Compressor 11 remaining operating hours (line 1)	...	h	0...999999
	Compressor 12	Compressor 12 operating hours (line 1)	---	h	0...999999
	(Check in...)	Compressor 12 remaining operating hours (line 1)	...	h	0...999999
Cac13	Compressor threshold working hours	Compressor maintenance threshold hours (line 1)	88000	h	0...9999999
Cac14	Compressor hours reset	Reset compressor operating hours (line 1)	N	---	NO / YES
Cad01	Enable suction setpoint compensation	Enable setpoint compensation (suction line 1)	NO	---	NO / YES
	Enable compensation by analog IN	Enable setpoint compensation by probe (suction line 1)	NO	---	NO / YES
Cad02	Winter offset	Offset applied for Winter period	0.0	...	-999.9...999.9
	Closing offset	Offset applied for closing period	0.0	...	-999.9...999.9
Cad03	Enable setpoint compensation by scheduler	Enable scheduler setpoint compensation (suction line 1)	NO	---	NO / YES
Cad04	Activ.Time Bands	Day of the week	---	---	MON, TUE, ...SUN
	TB1: --- --> ---	Time band 1 enabling and definition: start hour and minute, end hour and minute (suction line 1)	---

	TB4: --- --> ---	Time band 4 enabling and definition: start hour and minute, end hour and minute (suction line 1)	---
	Changes	Time band change action	---	---	---
Cad05	Copy to	Copy settings to other days	0	---	MONDAY...SUNDAY; MON-FRI; MON-SAT; SAT&SUN; ALL DAYS
	Change set by DI	Enable setpoint compensation by digital input (suct/cond line 1)	NO	---	NO / YES
Cad06	---	Position of the probe for suction pressure setpoint compensation (line1)	---	---	---, B1...B10 (****)
	---	Type of the probe for suction pressure setpoint compensation (line1)	4-20mA	---	---
	---	Compensation value (line 1)	---	...	0-1V - 0-10V- 4-20mA- 0-5V
	---	Maximum value of compensation (line 1)	---	...	-99.9...99.9
	---	Minimum value of compensation (line 1)	---	...	-99.9...99.9
Cad08	Enable floating suction setpoint	Enable floating setpoint (suction line 1)	NO	---	NO / YES
Cad09	Maximum floating setpoint	Max compressor floating setpoint settable (line 1)	... (**) (**)
	Minimum floating setpoint	Minimum compressor floating setpoint settable (line 1)	... (**) (**)
Cad10	Max.setpoint variation admitted	Maximum delta admitted for floating setpoint (suction line 1)	... (**) (**)
	Offline decreasing time	Reduction time when supervisor is offline for floating setpoint (suction line 1)	0	min	0...999
Cad11	Enable interactions with pLoads	Enable interactions with pLoads (line 1)	NO	---	NO / YES
	Pressure threshold disabled	Suction pressure threshold for disabling pLoads (line 1)	...(**)	...	0.0 to 99.9
	Reactivate delay	pLoads activation delay, previously disabled by a threshold	60	s	60...9999
Cad12	Config. action 1	Configuration of action associated with the first digital input connected to pLoads (line 1)	NO ACTION	---	NO ACTIONLIMIT TO CURRENT CAPACITYLIMIT CAPACITY TODEC. CAPACITY BY
	---	Percentage value to limit capacity to or reduce capacity by if the "LIMIT CAPACITY TO" or "LIMIT CAPACITY BY" actions have been configured respectively (line 1)	0.0	%	0.0 to 100.0
	Config. action 2	Configuration of action associated with the second digital input connected to pLoads (line 1)	NO ACTION	---	NO ACTIONLIMIT TO CURRENT CAPACITYLIMIT CAPACITY TODEC. CAPACITY BY
	---	Percentage value to limit capacity to or reduce capacity by if the "LIMIT CAPACITY TO" or "LIMIT CAPACITY BY" actions have been configured respectively (line 1)	0.0	%	0.0 to 100.0
Cad13	Enable supervisor action	Enable pLoads action from supervisor (line 1)	NO	---	NO / YES
	Enable	Enable calculation of power consumption	NO	---	NO / YES
	Load	Number of phases	SINGLE-PHASE	---	SINGLE-PHASE/THREE-PHASE
	Voltage	Mains voltage	400	V	0 to 999
	Cos(phi)	Displacement (cosφ)	1.0	---	0.0 to 1.0
	Reset counter	Reset current power counter	NO	---	NO / YES

Mask index	Display description	Description	Default	UOM	Values
Cae01	Number of alarms for each compressor	Number of alarms for each compressor (line 1)	1/4 (*)	---	0...4/7 (*)
Cae02	Alarm1 description	Selection of the first compressor alarm description: Generic, Overload, High pressure, Low pressure, Oil (line 1)	...	---	<input checked="" type="checkbox"/> (Not available) <input type="checkbox"/> (Not selected) <input checked="" type="checkbox"/> (Selected)
Cae03	Alarm1 description (*)	Selection of the first compressor alarm description: Rotation, Oil warning (line 1)	...	---	<input checked="" type="checkbox"/> (Not available) <input type="checkbox"/> (Not selected) <input checked="" type="checkbox"/> (Selected)
Cae04	Activ.delay	Activation delay for compressor alarm 1 during working (line 1)	0	s	0...999
	Start up delay	Activation delay for compressor alarm 1 at start up (line 1)	0	s	0...999
	Reset	Type of reset for compressor alarm 1 (line 1)	AUT.	---	AUT. / MAN.
	Priority	Type of priority for compressor alarm 1 (line 1)	SERIOUS	---	LIGHT / SERIOUS
...
Cae24	Suction pressure/temperature high alarm	Type of high suction pressure/temperature alarm threshold	ABSOLUTE	---	ABSOLUTE / RELATIVE
	Threshold	High suction pressure/temperature alarm threshold	... (**) (**)
Cae25	Alarm diff.	High suction pressure/temperature alarm differential	... (**) (**)
	Alarm delay	High suction pressure/temperature alarm delay	120	s	0...999
Cae26	Suction pressure/temperature low alarm	Type of low suction pressure/temperature alarm threshold	ABSOLUTE	---	ABSOLUTE / RELATIVE
	Threshold	Low suction pressure/temperature alarm threshold	... (**) (**)
Cae27	Alarm diff.	Low suction pressure/temperature alarm differential	... (**) (**)
	Alarm delay	Low suction pressure/temperature alarm delay	30	s	0...999
Cae28	Enable oil temperature alarm management (*)	Enable Digital Scroll™ oil temperature alarm (line 1)	NO	---	NO / YES
	Enable discharge temp. alarm management (*)	Enable Digital Scroll™ discharge temperature alarm (line 1)	NO	---	NO / YES
Cae29	Low superheat alarm threshold	Threshold for low superheat alarm (line 1)	3,0	K	0.0...99.9
	Alarm diff.	Low superheat alarm differential (line 1)	1,0	K	0.0...9,9
	Switch OFF comp.	Enable compressor off for low superheat alarm (line 1)	NO	---	NO / YES
	Reset	Type of low superheat alarm reset (line 1)	MANUAL	---	MANUAL / AUTO
	Alarm delay	Low superheat alarm delay (line 1)	30	s	0...999
Cae30	Time of semi-automatic alarm evaluation	Time of semi-automatic alarm evaluation for screw compressors out of envelope (line 1)	2	min	0...999
	N° of retries before alarm becomes manual	Number of retries before alarm becomes manual (line 1)	3	---	0...9
Cae40	Switch off comp.1	Enable compressor 1 off for compressor inverter warning (line 1)	NO	---	NO / YES
	Reset	Type of compressor inverter warning reset (line 1)	MANUAL	---	MANUAL/AUTO
	Alarm delay	Compressor inverter warning activation delay (line 1)	0	s	0...999
Caf02	Compressors type	Type of compressors (line 1)	RECIPROCATING	---	RECIPROCATING SCROLL SCREW
	Compressors number	Number of compressors (line 1)	2/3 (*)	---	1...6/12 (*)
Caf03	Cmp1,...	Enable compressors (line 1)	DIS	---	DIS / EN
Caf04	Refrigerant type	Type of refrigerant (suction Line 1)	R404A	---	R22 - R134a - R404A - R407C - R410A - R507A - R290 - R600 - R600a - R717 -R744 - R728 - R1270 - R417A - R422D -R413A - R422A - R423A - R407A - R427A - R245Fa - R407F - R32
Caf05	Min on time	Minimum compressor on time (line 1)	30	s	0...999
	Min off time	Minimum compressor off time (line 1)	120	s	0...999
	Min time to start same compressor	Minimum time between same compressor starts (line 1)	360	s	0...999
Caf06	Ignition type	Type of compressors start up	DIRECT	---	DIRECT PART WINDING STAR DELTA
Caf07	Star time	Star relay run time	0	ms	0...9999
	Star line delay	Delay between star and line relay	0	ms	0...9999
	Star delta delay	Delay between star and delta relay	0	ms	0...9999
Caf08	Partwinding delay	Partwinding delay	0	ms	0...9999
Caf09	Equalization	Enable compressors equalization at start up	NO	---	NO / YES
	Equalizat.time	Equalization duration	0	s	0...999
Caf10	Devices rotation type	Type of rotation	FIFO	---	----- FIFO LIFO TIME CUSTOM
Caf11	Dev. unload sequence	Unloader sequence in relation to compressor activation (C=compressor, p=unloader)	CpppCppp	---	----- CCpppppp CpppCppp
Caf12	Load up time	Delay between different compressor starts	10	s	0...999
	Load down time	Delay between different compressor stops	0	s	0...999
	Unloader delay	Delay between stages	0	s	0...999
Caf13	Custom rotation Switch ON order	Order of switch ON for compressor custom rotation	1	---	1...16
Caf14	Custom rotation Switch OFF order	Order of switch OFF for compressor custom rotation	1	---	1...16
Caf15	Modulate speed device	Compressor driver type (line 1)	NONE	---	NONE INVERTER DIGITAL SCROLL CONTINUOUS SCREW

Mask index	Display description	Description	Default	UOM	Values
Caf16	Min. frequency	Minimum inverter frequency	30	Hz	0...150
	Max. frequency	Maximum inverter frequency	60	Hz	0...150
Caf17	Min on time	Compressor controlled by inverter minimum ON time (line 1)	30	s	0...999
	Min off time	Compressor controlled by inverter minimum OFF time (line 1)	60	s	0...999
	Min time to start same compressor	Compressor controlled by inverter minimum time between same compressor starts (line 1)	180	s	0...999
Caf18	Digital Scroll™ comp. valve regulation	Digital Scroll™ comp. valve control type (line 1)	OPTIMISED CONTROL	---	OPTIMISED CONTROL VARIABLE CYCLE TIME FIXED CYCLE TIME
	Cycle time	Cycle time value (line 1)	13	s	12...20
Caf19	Oil dilution	Digital Scroll™, enable oil temperature alarm (line 1)	ENABLE	---	DISABLE/ENABLE
	Disch.temper.	Digital Scroll™, enable discharge temperature alarm (line 1)	ENABLE	---	DISABLE/ENABLE
Caf20	Compr.Manufacturer	Compressor manufacturer for screw compressors	GENERIC	---	GENERIC BITZER REFCOMP HANBELL
	Compressor series	Compressor series	...(***)	---	...(***)
Caf21	Number of valves	Number of valves used for capacity control	3	---	1...4
	Stages configuration	Stage configuration for screw compressor 1	25/50/75/100	%	100; 50/100; 50/75/100; 25/50/75/100; 33/66/100
Caf22	Common time	Enable common delay time (from one stage to the following) for screw compressor 1	ENABLE	---	DISABLE/ENABLE
	Common time/time between steps	Common delay time (from one stage and the following) for screw compressor 1	0	s	0...999
	From...to...	Minimum compressor delay time in order to reach each capacity stage from previous for screw compressor 1	...	s	0...999
Caf23	Intermittent valve time	Intermittent on/off time for capacity control valves for screw compressor 1	10	s	0...99
Caf24	Valve conf.	Configuration of the behaviour of the valves during start/stop and stages for screw compressor 1	...	---	O (ON) X (OFF) I (Intermittent) P (Pulsing)
Caf25	Limit comp.permanence at min power	Enable time limit at minimum capacity for screw compressor 1	ENABLE	---	DISABLE ENABLE
	Max.perman.time	Max time for compressor operation at minimum capacity for screw compressor 1	60	s	0...9999
	Limitat.on for	Time to return to minimum after the compressor was forced to second stage after staying at minimum for maximum time for screw compressor 1	0	s	0...9999
Caf26	Min.output power	Minimum compressor capacity in case of high capacity range (usually 25%), only for continuous compressors	25	%	0...100
Caf27	Compressor start-up phase duration	Start-up phase time (after electric start-up)	10	s	0...999
	Maximum time to reach -maximum power	Maximum time in order to reach maximum compressor capacity (continuous capacity control)	120	s	0...999
	-minimum power	Minimum time in order to reach minimum compressor capacity (continuous capacity control)	120	s	0...999
Caf28	Intermittent	Intermittent on/off time for capacity control valves	10	s	0...99
	Pulse period	Pulsing period for valves (for continuous compressors)	3	s	1...10
	Min.Puls.Incr.	Minimum pulse time for increase capacity (valves control)	0,5	s	0,0...9,9
	Max.Puls.Incr.	Maximum pulse time for increase capacity (valves control)	1,0	s	0,0...9,9
	Min.Puls.Decr.	Minimum pulse time for decrease capacity (valves control)	0,5	s	0,0...9,9
Caf29	Max.Puls.Decr.	Maximum pulse time for decrease capacity (valves control)	1,0	s	0,0...9,9
	Valve conf.	Configuration of the behaviour of the valves during start/stop, incr. min% to 100%, decr.100% to min%, standby, decr.100% to 50%	...	---	O (ON) X (OFF) I (Intermittent) P (Pulsing)
Caf36	Number of valves	Number of control capacity valves for screw compressor 2	3	---	1...4
	Stages configuration	Stage configuration for screw compressor 2	25/50/75/100	%	100; 50/100; 50/75/100; 25/50/75/100; 33/66/100
...	---	...
Caf90	Different sizes	Enable compressors of different sizes (line 1)	NO	---	NO / YES
	Different number of valves	Enable compressor capacity control (line 1)	NO	---	NO / YES
Caf91	S1	Enable size and size for compressor group 1 (line 1)	YES 10,0	---	NO / YES 0,0...500,0 kW
	S4	Enable size and size for compressor group 4 (line 1)	NO	---	---
Caf92	S1	Enable stages and stages for compressor group 1 (line 1)	YES 100	---	NO/YES 100; 50/100; 50/75/100; 25/50/75/100; 33/66/100 %
	S4	Enable stages and stages for compressor group 4 (line 1))	NO	---	NO / YES S1...S4 kW
Caf93	C01	Size group for compressor 1 (line 1) or presence of inverter	S1	---	S1...S4/INV
	C12	Size group for compressor 6 (line 1)	S1	---	S1...S4

Mask index	Display description	Description	Default	UOM	Values
Caf95	Min on time	Minimum Digital Scroll™ compressor On time (line 1)	60	s	0...999
	Min off time	Minimum Digital Scroll™ compressor Off time(line 1)	180	s	0...999
	Min time to start same compressor	Minimum time between starts for Digital Scroll™ compressor (line 1)	360	s	0...999
	Reactivate start-up procedure after	Digital Scroll™ compressor start-up procedure reactivation time (line 1)	480	min	0...9999
Cag01	Minimum voltage	Voltage corresponding to the minimum capacity of the inverter (line 1)	0.0	V	0.0...10.0
	Maximum voltage	Voltage corresponding to the maximum capacity of the inverter (line 1)	10.0	V	0.0...10.0
	Nominal freq.	Nominal frequency (nominal capacity at nominal frequency) (line 1)	50	Hz	0...150
	Nominal power	Nominal capacity for compressor managed by inverter at nominal frequency (line 1)	10.0	kW	0.0...500.0
Cag02	Rising time	Time to pass from min capacity to max capacity for modulating device (line 1)	90	s	0...600
	Falling time	Time to pass from max capacity to min capacity for modulating device (line 1)	30	s	0...600
Cag03	Enable compressor modulation inside neutral zone	Enable compressor 1 modulation inside Neutral zone (line 1)	YES	---	NO / YES
Cag04	Enable suction press. backup probe	Enable screens for suction pressure backup probe configuration (line 1)	NO	---	NO / YES
Cag05	Request in case of regulat. probe fault	Compressor forcing value in case of suction probes fault (line 1)	50.0	%	0.0...100.0
Cag06	Enable anti liquid return valve	Enable liquid non return function (line 1)	NO	---	NO / YES
Cag07	Enable compressor envelope management (*)	Enable compressor envelope management (screw only). <i>For details on configuration contact Carel.</i>	NO	---	NO / YES

The following parameters refer to line 2, for details see the corresponding parameters for line 1 above

Cba01	DI	Alarm 1 for compressor 1 DI position (line 2)	03	---	---, 01...18, B1...B10 (****)
	Status (display only)	Status of alarm 1 for compressor 1 DI (line 2)	---	---	Closed / Open
	Logic	Logic of alarm 1 for compressor 1 DI (line 2)	NC	---	NC / NO
	Function (display only)	Alarm 1 for compressor 1 function status (line 2)	---	---	Not active Active
...
Cbb01	Regulation by	Compressor control by temperature or pressure (line 2)	PRESSURE	---	PRESSURE TEMPERATURE
	Regulation type	Compressor control type (line 2)	NEUTRAL ZONE	---	PROPORTIONAL BAND NEUTRAL ZONE
...
Cbc01	Working hours Compressor 1	Compressor 1 max operating hours (line 2)	---	---	0...999999
...
Cbd01	Enable suction setpoint compensation	Enable setpoint compensation (suction line 2)	NO	---	NO / YES
	Enable compensation by analog IN	Enable setpoint compensation by probe (suction line 2)	NO	---	NO / YES
...
Cbe01	Number of alarms for each compressor	Number of alarms for each compressor (line 2)	1	---	0 to 4
...
Cbf02	Compressors type	Type of compressors (line 2)	RECIPROCATING	---	RECIPROCATING SCROLL
	Compressors number	Number of compressors (line 2)	2/3 (*)	---	1...12
...
Cbg01	Minimum voltage	Voltage corresponding at the minimum capacity of the inverter (line 2)	0.0	Hz	0.0...10.0
	Maximum voltage	Voltage corresponding at the maximum capacity of the inverter (line 2)	10.0	Hz	0.0...10.0
	Nominal freq.	Nominal frequency (nominal capacity at nominal frequency) (line 2)	50	Hz	0...150
	Nominal power	Nominal capacity for compressor managed by inverter at nominal frequency (line 2)	10.0	kW	0.0...500.0
...

Mask index	Display description	Description	Default	UOM	Values
------------	---------------------	-------------	---------	-----	--------

 **D. Condensers** (The I/Os available depend on the selected configuration, the following are just some examples. For the complete list of I/O positions available see Appendix A.5)

Daa01	DI	Fan 1 overload DI position (line 1)	...	---	---, 01...18, B1...B10 (****)
	Status (display only)	Status of fan 1 overload DI (line 1)	---	---	Closed Open
	Logic	Logic of fan 1 overload DI (line 1)	NC	---	NC / NO
	Function (display only)	Fan 1 overload function status (line 1)	---	---	Not active Active
...
Daa39	---	Condenser probe position (line 1)	B1	---	---, B1...B10 (****)
	---	Condenser probe type (line 1)	4-20mA	---	0-1V 0-10V 4-20mA 0-5V
	--- (display only)	Condensing pressure value (line 1)	--- (**)
	Max limit	Maximum condensing pressure value (line 1)	30,0 barg (**)
	Min limit	Minimum condensing pressure value (line 1)	0,0 barg (**)
	Calib.	Condensing pressure probe calibration (line 1)	0,0 barg (**)
...

Mask index	Display description	Description	Default	UOM	Values
Daa21	DO	Fan 1 DO position (line 1)	03	---	---, 01...29 (***)
	Status (display only)	Status of fan 1 DO (line 1)	---	---	Closed / Open
	Logic	Logic of fan 1 DO (line 1)	NC	---	NC / NO
	Function (display only)	Fan 1 function status (line 1)	---	---	Not active / Active
...
Daa38	AO	Inverter fan AO position (line 1)	0	---	---, 01...06 (***)
	Type (***)	Type of output, PWM / phase control per AO fan inverters (line 1)	FCS1*-CON-VONOFF	---	FCS1*-CONVONOFF; "-----" MCHRTF*"; FCS3*-CONV010"
	Status (display only)	Inverter fan output value (line 1)	0	%	0.0...100.0
...
Dab01	Regulation by	Condenser control by temperature or pressure (line 1)	PRESSURE	---	PRESSURE/TEMPERATURE
	Regulation type	Condenser control type (line 1)	PROPORTI. BAND	---	PROPORTIONAL BAND NEUTRAL ZONE
Dab02	Minimum	Condenser setpoint lower limit (line 1)	... (**) (**)
	Maximum	Condensers setpoint higher limit (line 1)	... (**) (**)
Dab03	Setpoint	Condenser setpoint (line 1)	... (**) (**)
Dab04	Fans work only when at least one compressor works	Enable fan operation linked to compressor operation	NO	---	NO / YES
Dab05	Cut_Off enable	Enable fan cut-off function	NO	---	NO / YES
	Cut-Off request	Cut-off value	0.0	%	0.0...100.0
	Diff.	Cut-off differential	... (**) (**)
	Hysteresis	Cut-off hysteresis	... (**) (**)
Dab6/ Dab8 (**)	Reg.type	Type for proportional control (condenser line 1)	PROP.	---	PROP. PROP.+HINT.
	Integral time	Integral time for prop. control (cond. line 1)	300	s	0..999
Dab7/ Dab9 (**)	Differential	Differential for proportional control (cond. line 1)	... (**) (**)
Dab10/Dab11 (**)	NZ diff.	Neutral zone control differential (line 1)	... (**) (**)
	Activ.diff.	Neutral zone control differential for device activation (line 1)	... (**) (**)
	Deact.diff.	Neutral zone control differential for device deactivation (line 1)	... (**) (**)
Dab12/Dab13 (**)	En.force off power	Enable capacity immediate decreasing to 0 (line 1)	NO	---	NO / YES
	Setp.for force off	Threshold for capacity decreasing to 0 (line 1)	... (**) (**)
Dab14	Power load to 100% min time	Minimum time to increase capacity request to 100%, Neutral zone control (condenser line 1)	15	s	0..9999
	Power load to 100% max time	Maximum time to increase capacity request to 100%, Neutral zone control (condenser line 1)	90	s	0..9999
Dab15	Power unload to 0% min time	Minimum time to decrease capacity request to 0%, Neutral zone control (condenser line 1)	30	s	0..9999
	Power unload to 0% max time	Maximum time to decrease capacity request to 0%, Neutral zone control (condenser line 1)	180	s	0..9999
Dad01	Enable condensing setpoint compensation	Enable setpoint compensation (condenser line 1)	NO	---	NO / YES
Dad02	Winter offset	Enable setpoint compensation (condenser line 1)	0.0	...	-999.9...999.9
	Closing offset	Offset applied for Winter period	0.0	...	-999.9...999.9
Dad03	Enable setpoint compensation by scheduler	Enable scheduler setpoint compensation (condenser line 1)	NO	---	NO / YES
	Activ.Time Bands	Day of the week	---	---	MON, ...SUN
	TB1: --:-- --:--	Time band 1 enabling and definition: start hour and minute, end hour and minute (suction line 1)	---

Dad04	TB4: --:-- --:--	Time band 4 enabling and definition: start hour and minute, end hour and minute (suction line 1)	---
	Changes	Time band changes action	---	---	---
	Copy to	Copy settings to other days	0	---	MONDAY...SUNDAY; MON-FRI; MON-SAT; SAT&SUN; ALL DAYS
Dad05	Enable floating condensing setpoint	Enable floating setpoint (condenser line 1)	NO	---	NO / YES
Dad06	Offset for external temperature	Temperature delta for floating setpoint (condenser line 1)	0.0	...	-9.9...9.9
	Controlled by: -Digital input	Enable floating condensing from digital input	NO	---	NO / YES
Dad07	Change set by digital input	Enable setpoint compensation by digital input (suction/condensing line 1)	NO	---	NO / YES
Dae01	Cond.pressure/temperature high alarm	Type of high condensing pressure/temperature alarm threshold (line 1)	ABSOLUTE	---	ABSOLUTE / RELATIVE
	Threshold	High condensing pressure/temperature alarm threshold (line 1)	24.0 barg (**)
Dae02	Cond.pressure/temperature alarm diff.	High condensing pressure/temperature alarm differential (line 1)	1.0 barg (**)
	Alarm delay	High condensing pressure/temperature alarm delay (line 1)	60	s	0..999
Dae03	Cond.pressure/temperature low alarm	Type of low condensing pressure/temperature alarm threshold (line 1)	ABSOLUTE	---	ABSOLUTE / RELATIVE
	Threshold	Low condensing pressure/temperature alarm threshold (line 1)	7.0 barg (**)
Dae04	Cond.pressure/temperature alarm diff.	Low condensing pressure/temperature alarm differential (line 1)	1.0 barg (**)
	Alarm delay	Low condensing pressure/temperature alarm delay (line 1)	30	s	0..999
Dae05	Common fan overload	Common fan overload (line 1)	YES	---	NO / YES
	Delay	Common fan overload alarm activation delay	AUTOMATIC	---	AUTOMATIC / MANUAL
	Reset	Type of common fan overload alarm reset	0	s	0 to 500
Daf01	Number of present fans	Number of fans (line 1)	3	---	0 to 16
Daf02	Fan1, Fan2, ...	Enable fans 1 to 12 (line 1)	EN	---	DIS / EN
Daf03	Fan13, Fan14, ...	Enable fans 13 to 16 (line 1)	EN	---	DIS / EN

Mask index	Display description	Description	Default	UOM	Values
Daf04	Refrigerant type	Type of refrigerant (condenser line 1)	R404A	---	R22 - R134a - R404A - R407C - R410A - R507A - R290 - R600 - R600a - R717 - R744 - R728 - R1270 - R417A - R422D - R413A - R422A - R423A - R407A - R427A - R245Fa - R407F - R32
Daf05	Devices rotation type	Type of rotation devices (condenser line 1)	FIFO	---	----- FIFO LIFO TIME CUSTOM
Daf07, Daf08	Custom rotation Switch ON order	Switch ON order for fans with custom rotation (condenser line 1)	1	---	1...16
Daf09, Daf10	Custom rotation Switch OFF order	Switch OFF order for fans with custom rotation (condenser line 1)	1	---	1...16
Dag01	Modulate speed device	Fan driver type (line 1)	NONE	---	NONE INVETER PHASE CONTROL
	Type (****)	Type of output, PWM / phase control for condenser modulating device (line 1)	---	---	----- MCHRTF* FCS3*-CONV010 NO / YES
Dag02	Neutral zone req.	Fan control also inside Neutral zone (line 1)	NO	---	NO / YES
	Min.out value	Minimum voltage for compressor inverter (line 1)	0.0	V	0.0 to 9.9
	Max.out value	Maximum voltage for compressor inverter (line 1)	10.0	V	0.0 to 99.9
	Min. power refer.	Minimum capacity of fan modulating device (line 1)	60	%	0...100
Dag03	Max. power refer.	Maximum capacity of fan modulating device (line 1)	100	%	0...999
	Rising time	Time to pass from min capacity to max capacity for fan modulating device (line 1)	1200	s	0 to 32000
	Falling time	Time to pass from max capacity to min capacity for fan modulating device (line 1)	1200	s	0 to 32000
Dag04	Num.control.fans	Number of fans under inverter (only for alarm enabling)	1	---	0 to 16
	Split Condenser	Enable split condenser (line 1)	NO	---	NO / YES
	Controlled by: -Digital input	Split Condenser controlled by digital input (line 1)	---	---	NO / YES
	-External temp. -Scheduler	Split Condenser controlled by outside temperature (line 1) Split Condenser controlled by scheduler (line 1)	---	---	NO / YES NO / YES
Dag05	Est. Temp.Thr.	Split condenser by outside temperature management setpoint (line 1)	10.0 °C	...	-99.9...99.9
	Est. Temp.Diff.	Split condenser by outside temperature management differential (line 1)	2.5 °C	...	-99.9...99.9
Dag06	Type	Fans enabled with split condenser (line 1)	CUSTOM	---	CUSTOM ODD EVEN GREATER THAN LESS THAN
	---	Only when enabling type is GREATER THAN or LESS THAN, number of fans to consider for splitting (line 1)	0	---	0 to 16
Dag09	Disable split condenser as first stage of HP pressostat for	Disable split condenser when high condensing pressure prevent occurs (line 1)	NO	---	NO / YES
		Duration of split condenser deactivation for high condensing pressure prevent (line 1)	0	h	0 to 24
Dag10	Anti-noise	Enable silencer (line 1)	DISAB.	---	DISABLE / ENABLE
	Max output	Maximum request allowed when silencer function is active (line 1)	75.0 %	%	0.0...100.0
	Controlled by: -Digital input	Silencer controlled by digital input (condenser line 1)	NO	---	NO / YES
	-Scheduler	Silencer controlled by scheduler (condenser line 1)	NO	---	NO / YES
Dag12	Activ.Time Bands	Day of the week	---	---	MON, ..., SUN
	TB1: --:-- -> --:--	Time band 1 enabling and definition: start hour and minute, end hour and minute (condenser line 1)	---
	---	---	---	---	---
	TB4: --:-- -> --:--	Time band 4 enabling and definition: start hour and minute, end hour and minute (condenser line 1)	---
	Changes	Time band changes action	---	---	---
	Copy to	Copy settings to other days	0	---	MONDAY...SUNDAY; MON-FRI; MON-SAT; SAT&SUN; ALL DAYS
Dag13	Speed Up	Enable speed up (condenser line 1)	YES	---	NO / YES
	Speed Up time	Speed up time (condenser line 1)	5	s	0...60
	Ext.Temp.Manage	Enable speed up management by outside temperature (condenser line 1)	DIS	---	DIS / EN
	Ext.Temp.Thresh.	Outside temperature threshold for speed up management (condenser line 1)	25.0 °C	...	-99.9...99.9
	Ext.Temp.Diff.	Outside temperature differential for speed up management (condenser line 1)	2.5 °C	...	-99.9...99.9
Dag14	Enable condensing press. backup probe	Enable the screens for condensing pressure backup probe configuration (condenser line 1)	NO	---	NO / YES
Dag15	Request in case of egulat. probes fault	Value of fans forcing in case of condensing probes fault (line 1)	50.0	%	0.0...100.0

The following parameters refer to line 2, for details see the corresponding parameters for line 1 above

Mask index	Display description	Description	Default	UOM	Values
Dba01	DI	Fan 1 overload DI position (line 2)	...	---	---, 01...18, B1...B10 (****)
	Status (display only)	Status of fan 1 overload DI (line 2)	---	---	Closed / Open
	Logic	Logic of fan 1 overload DI (line 2)	NC	---	NC NO
	Function (display only)	Fan 1 overload function status (line 2)	---	---	Not active Active
...
Dbb01	Regulation by	Condenser control by temperature or pressure (line 2)	PRESSURE	---	PRESSURE TEMPERATURE
	Regulation type	Condenser control type (line 2)	NEUTRAL ZONE	---	PROPORTIONAL BAND NEUTRAL ZONE
...
Dbd01	Enable condensing setpoint compensation	Enable setpoint compensation (condenser line 2)	NO	---	NO YES

Dbe01	Cond.temperature/pressure high alarm	Type of high condensing pressure/temperature alarm threshold (line 2)	ABSOLUTE	---	ABSOLUTE RELATIVE
	Threshold	High condensing pressure/temperature alarm threshold (line 2)	24,0 barg (**)
...
Dbf01	Number of present fans	Number of fans (line 2)	3	---	0 to 16
	---	...
Dbg01	Modulate speed device	Fan driver type (line 2)	NONE	---	NONE INVETER PHASE CONTROL
	Type (****)	Type of output, PWM / phase control for condenser modulating device (line 2)	----	---	MCHRTF* FCS3*-CONV010
...	---	...

Mask index	Display description	Description	Default	UOM	Values
------------	---------------------	-------------	---------	-----	--------

 **Other functions.** (The I/Os available depend on the selected configuration, the following are just some examples. For the complete list of I/O positions available see Appendix A.5)

Eaaa04	---	Oil temperature probe position (line1)	B1	---	---, B1...B10 (****)
	---	Oil temperature probe type (line 1)	4-20mA	---	---
	--- (display only)	Oil temperature probe value (line 1)	--- (**)
	Upper value	Oil temperature probe max. limit (line 1)	30.0 barg (**)
	Lower value	Oil temperature probe min. limit (line 1)	0.0 barg (**)
	Calibration	Oil temperature probe adjustment (line 1)	0.0 barg (**)
...	---	---
Eaaa45	DO	Oil level valve DO position, compressor 6 (line 1)	03	---	---, 01...29 (****)
	Status (display only)	Oil level valve DO status, compressor 6 (line 1)	---	---	Closed / Open
	Logic	Oil level valve DO logic, compressor 6 (line 1)	NC	---	NC / NO
	Function (display only)	Oil level function status, compressor 6 (line 1)	---	---	Not active / Active
Eaab04	Common oil cooler	Enable common oil cooling (line 1)	YES	---	NO / YES
	Oil pumps number	Number of oil pumps for common oil cooler (line 1)	0	---	0 to 1 (Analog output) 0 to 2 (Digital outputs)
	Enable Aout pump	Enable AO of common oil cooler pump (line 1)	YES	---	NO (Digital outputs) YES (Analog output)
Eaab05	Setpoint	Common oil cooler setpoint (line 1)	0.0 °C (**)
	Differential	Common oil cooler differential (line 1)	0.0 °C	...	-9.9...9.9
Eaab06	Pump start delay	Time delay before the start-up of pump 2 after pump1 turns on (line 1)	0	s	0...999
Eaab07	Oil pumps number	Screw compressors: number of oil cooler pumps enabled (line1)	0	---	0 to 1 (Analog output) 0 to 2 (Digital outputs)
	Enable Aout pump	Screw compressors: enable AO for oil cooler pump (line 1)	YES	---	NO (Digital outputs) YES (Analog output)
Eaab08	Setpoint	Screw compressors: oil temperature setpoint (line 1)	0.0	°C/°F	...
	Differential	Screw compressors: oil temperature differential (line 1)	0.0	°C/°F	...
Eaab09	Threshold	Common oil high temperature alarm threshold (line 1)	100.0 °C	°C/°F	...
	Differential	Common oil high temperature alarm differential (line 1)	10.0 °C	°C/°F	...
	Delay	Common oil high temperature alarm delay (line 1)	0	s	0 to 32767
Eaab10	En.oil lev.manag.	Enable oil level management (line 1)	NO	---	NO / YES
	Num.Alarm oil level	Number of compressor alarm associated with oil level (line 1)	0	---	0 to 4/7 (*)
Eaab11	Time open	Oil level valve opening time (line 1)	0	s	0...999
	Time close	Oil level valve closing time (line 1)	0	s	0...999
Ebaa01	DO	Subcooling valve DO position (line 1)	...	---	---, 01...29 (****)
	Status (display only)	Status of subcooling valve DO (line 1)	---	---	Closed / Open
	Logic	Logic of subcooling valve (line 1)	NO	---	NC / NO
	Function (display only)	Subcooling valve function status (line 1)	---	---	Not active / Active
Ebab01	Subcooling control	Enable subcooling function (line 1)	NO	---	NO / YES
	---	Subcooling control type (line 1)	BY COND. & LIQUID TEMP.	---	BY COND.& LIQUID TEMP. ONLY BY LIQUID. TEMP.
	Threshold	Threshold for subcooling control (line 1)	0.0 °C	...	-9999.9...9999.9
	Subcool.value (display only)	Subcooling value (line 1)	0.0 °C	...	-999.9...999.9
Ecaa01	---	Discharge temperature probe position, compressor 1 (line 1)	B1	---	---, B1...B10 (****)
	---	Type of discharge temperature probe, compressor 1 (line 1)	4-20mA	---	---
	--- (display only)	Discharge temperature value, compressor 1 (line 1)	--- (**)
	Upper value	Maximum discharge temperature value, compressor 1 (line 1)	30.0 barg (**)
	Lower value	Minimum discharge temperature value, compressor 1 (line 1)	0.0 barg (**)
	Calibration	Discharge temperature probe calibration, compressor 1 (line 1)	0.0 barg (**)

Mask index	Display description	Description	Default	UOM	Values
...
Ecaa12	DO	Economizer valve DO position, compressor 6 (line 1)	...	---	---, 01...29 (****)
	Status (display only)	Economizer valve DO status, compressor 6 (line 1)	---	---	Closed / Open
	Logic	Economizer valve DO logic, compressor 6 (line 1)	NO	---	NC / NO
	Function (display only)	Economizer valve function status, compressor 6 (line 1)	---	---	Not active / Active
Ecab04 (*)	Economizer	Enable economizer function (line 1)	NO	---	NO / YES
	Compr.Power Thr.	Capacity percentage threshold for economizer activation (line 1)	0	%	0...100
	Press.Lim.	Condensing temperature threshold for economizer activation (line 1)	0.0 °C	...	-9999...9999
	Disch.T.Thr.	Discharge temperature threshold for economizer activation (line 1)	0.0 °C	...	-9999...9999
Ecab05 (*)	Economizer	Enable economizer function for screw compressor 1 (line 1)	NO	---	NO / YES
	Setpoint	Setpoint for economizer function with discharge temperature for screw compressor 1	... (**) (**)
	Differential	Differential for economizer function with discharge temperature for screw compressor 1	... (**) (**)
Ecab06 (*)	Min.power activ.	Minimum screw compressor 1 capacity for economizer activation	75	%	0; 25; 50; 75; 100
	Cond.press.check	Enable economizer function with condensing temperature for screw compressor 1	DIS	---	DIS / EN
	Setpoint	Setpoint for economizer function with condensing temperature for screw compressor 1	60.0	°C/°F	...
	Differential	Differential for economizer function with condensing temperature for screw compressor 1	5.0	°C/°F	...
Edaa01	---	Discharge temperature probe position, compressor 1 (line 1)	B1	---	---, B1...B10 (****)
	---	Compressor 1 discharge temperature probe position (line1)	4-20mA	---	---
	---	Compressor 1 discharge temperature probe type (line 1)	--- (**)
	Upper value	Compressor 1 discharge temperature probe value (line 1)	30.0 barg (**)
	Lower value	Compressor 1 discharge temperature probe max. limit (line 1)	0.0 barg (**)
	Calibration	Compressor 1 discharge temperature probe min. limit (line 1)	0.0 barg (**)
...	...	Compressor 1 discharge temperature probe adjustment (line 1)
Edaa12	DO	Injection valve DO position, compressor 6 (line 1)	...	---	---, 01...29 (****)
	Status (display only)	Injection valve DO status, compressor 6 (line 1)	---	---	Closed / Open
	Logic	Injection valve DO logic, compressor 6 (line 1)	NO	---	NC / NO
	Function (display only)	Injection valve function status, compressor 6 (line 1)	---	---	Not active / Active
Edab01/Edab03 (*)	Liquid Injection	Enable liquid injection function (line 1)	DIS	---	DIS / EN
	Threshold	Liquid injection set point (line 1)	70.0 °C (**)
	Differential	Liquid injection differential (line 1)	5,0 (**)
	DI	Heat recovery from digital input DI position (line 1)	...	---	---, 01...18, B1...B10 (****)
Eeaa02	Status (display only)	Status of heat recovery DI (line 1)	---	---	Closed / Open
	Logic	Logic of heat recovery DI (line 1)	NC	---	NC NO
	Function (display only)	Status of heat recovery from digital input DI function (line 1)	---	---	Not active / Active
	DO	Heat recovery pump DO position (line 1)	---	---	---, 01...29
Eeaa03	Status (display only)	Heat recovery pump DO status (line 1)	---	---	Closed / Open
	Logic	Heat recovery pump DO logic (line 1)	NC	---	NC / NO
	Function (display only)	Heat recovery pump status (line 1)	---	---	Not active / Active
	AO	Heat recovery damper AO position (line 1)	---	---	---, 01...29
Eeaa04	Type (****)	Type of output, PWM / phase control for heat recovery damper AO (line 1)	FCS1*-CON-VONOFF	---	FCS1*-CONVONOFF MCHRTF*
	Status	Heat recovery damper AO status (line 1)	---	---	FCS3*-CONV010
Eeaa05	---	Heat recovery outlet temperature probe position (line 1)	B1	---	---, B1...B10 (****)
	---	Type of heat recovery outlet temperature probe (line 1)	4-20mA	---	---
	---	Heat recovery outlet temperature value (line 1)	--- (**)
	Upper value	Maximum heat recovery outlet temperature value (line 1)	30.0 barg (**)
	Lower value	Minimum heat recovery outlet temperature value (line 1)	0.0 barg (**)
	Calibration	Heat recovery outlet temperature probe calibration (line 1)	0.0 barg (**)
Eeab01	Enable Heat Reclaim	Enable heat recovery function (line 1)	NO	---	NO / YES
Eeab02	Condensing pressure Lower Limit	Condensing pressure lower limit for heat recovery (line 1)	0.0 barg (**)
Eeab03	Modulation by temperat.	Enable heat recovery control by discharge temperature (line 1)	NO	---	NO / YES
Eeab04	Setpoint	Heat recovery: discharge temperature setpoint (line 1)	0.0 °C (**)
	Differential	Heat recovery: discharge temperature differential (line 1)	0.0 °C	...	0.0 ... 99.9
Eeab05	Disable floating condensing pressure	Disable floating condensing pressure when heat reclaim is active	NO	---	NO / YES
	Setpoint offset	Offset that must be applied to the condensing setpoint instead of floating condensing when heat reclaim is active	---	...	-99.9...99.9
Eeab06	Enable activation by scheduler	Enable heat recovery control by scheduler (line 1)	NO	---	NO / YES
Eeab07	Active.Time Bands	Week of the day	---	---	MON, ..., SUN
	TB1: --:-- -> --:--	Time band 1 enabling and definition: start hour and minute, end hour and minute (condenser line 1)	---
	---
	TB4: --:-- -> --:--	Time band 4 enabling and definition: start hour and minute, end hour and minute (condenser line 1)	---
	Changes	Time band changes action	---	---	---
	Copy to	Copy settings to other days	0	---	CONFIRM&SAVE LOAD PREVIOUS CLEAR ALL MONDAY...SUNDAY; MON-FRI; MON-SAT; SAT&SUN; ALL DAYS

Mask index	Display description	Description	Default	UOM	Values
Efa05	Gen.Funct.1	Enable generic stage function 1	DISAB.	---	DISABLE / ENABLE

Efa06	Gen.Funct.5	Enable generic stage function 5	DISAB.	---	DISABLE / ENABLE
	Regulation variable	Control variable for generic stage function 1	---	---	...
Efa07	Mode	Direct or reverse control	DIRECT	---	DIRECT / REVERSE
	Enable	Enabling variable for generic stage function 1	---	---	...
Efa08	Description	Enable description change	SKIP	---	SKIP / CHANGE
	-----	Description	---	---	...
Efa09	Setpoint	Setpoint for generic stage function 1	0.0 °C (**)
	Differential	Differential for generic stage function 1	0.0 °C (**)
Efa09	High alarm	High alarm enabling for generic stage function 1	DISAB.	---	DISABLE / ENABLE
	High alarm	High alarm threshold for generic stage function 1	0.0 °C (**)
	Delay time	High alarm delay for generic stage function 1	0	s	0...9999
	Alarm type	Low alarm enabling for generic stage function 1	LIGHT	---	LIGHT / SERIOUS
	Low alarm	Low alarm threshold for generic stage function 1	DISAB.	---	DISABLE / ENABLE
	Low alarm	Low alarm delay for generic stage function 1	0.0 °C (**)
	Delay time	Low alarm delay for generic stage function 1	0	s	0...9999
Efb05	Alarm type	Type of low alarm for generic stage function 1	LIGHT	---	LIGHT / SERIOUS
	---	---	...
Efb06	Gen.Modulat.1	Enable generic modulating function 1 management	DISAB.	---	DISABLE / ENABLE
	Gen.Modulat.2	Enable generic modulating function 2 management	DISAB.	---	DISABLE / ENABLE
Efb07	Regulation variable	Control variable for generic modulating function 1	---	---	...
	Mode	Direct or reverse modulation	DIRECT	---	DIRECT / REVERSE
Efb08	Enable	Enabling variable for generic modulating function 1	---	---	...
	Description	Enable description change	SKIP	---	SKIP / CHANGE
Efb09	-----	Description	---	---	...
	Setpoint	Setpoint for generic modulating function 1	0.0 °C (**)
Efb09	Differential	Differential for generic modulating function 1	0.0 °C (**)
	High alarm	High alarm enabling for generic modulating function 1	DISAB.	---	DISABLE / ENABLE
Efb10	High alarm	High alarm threshold for generic modulating function 1	0.0 °C (**)
	Delay time	High alarm delay for generic modulating function 1	0	s	0...9999
Efb20	Alarm type	Low alarm enabling for generic modulating function 1	LIGHT	---	LIGHT / SERIOUS
	Out upper limit	Output upper limit for generic modulating function 1	100.0	%	0...100
Efb20	Out lower limit	Output lower limit for generic modulating function 1	0.0	%	0...100
	Enable cutoff	Enable cut off function for generic modulating function 1	NO	---	NO / YES
Efc05	Cutoff diff.	Cut off differential for generic modulating function 1	0.0 °C (**)
	Cutoff hys.	Cut off hysteresis for generic modulating function 1	0.0 °C (**)
Efc06	Low alarm	Low alarm enabling for generic modulating function 1	DISAB.	---	DISABLE / ENABLE
	Low alarm	Low alarm threshold for generic modulating function 1	0.0 °C (**)
Efc07	Delay time	Low alarm delay for generic modulating function 1	0	s	0...9999
	Alarm type	Low alarm type for generic modulating function 1	LIGHT	---	LIGHT / SERIOUS
Efd05	---	---	...
	Gen.alarm 1	Enable generic alarm function 1 management	DISAB.	---	DISABLE / ENABLE
Efd06	Gen.alarm 2	Enable generic alarm function 2 management	DISAB.	---	DISABLE / ENABLE
	Regulation variable	Monitored variable for generic alarm function 1	---	---	...
Efd07	Enable	Enabling variable for generic alarm function 1	---	---	...
	Description	Enable description change	SKIP	---	SKIP / CHANGE
Efe05	-----	Description	---	---	...
	Alarm type	Alarm type for generic alarm function 1	LIGHT	---	LIGHT / SERIOUS
Efd07	Delay time	Delay for generic alarm function 1	0	s	0...9999
	---	---	...
Efd07	Generic Function Scheduler	Enable generic scheduler function	DISAB.	---	DISABLE / ENABLE
	Gen.funct.scheduling connected to global scheduling	Generic scheduler function considers the same special days and periods of global scheduler	NO	---	NO / YES
Efd07	Enable	Enabling variable for generic scheduler function	---	---	...
	Activ.Time Bands	Day of the week	---	---	MON, ..., SUN
Efd07	TB1: --:-- --:--	Time band 1 enabling and definition: start hour and minute, end hour and minute (suction line 1)	---	---	...
	---	---	...
Efd07	TB4: --:-- --:--	Time band 4 enabling and definition: start hour and minute, end hour and minute (suction line 1)	---	---	...
	Changes	Time band changes action	---	---	CONFIRM&SAVE LOAD PREVIOUS CLEAR ALL
Efe05	Copy to	Copy settings to other days	0	---	MONDAY...SUNDAY; MON-FRI; MON-SAT; SAT&SUN; ALL DAYS
	Gen.A Measure	Generic analogue input A unit of measure selection	°C	---	°C; °F; barg; psig; %; ppm -
Efe06/Efe07 (**)	---	---	...
	---	Generic probe A position	B1	---	---, B1...B10 (****)
Efe06/Efe07 (**)	---	Generic probe A type	4-20mA	---	... (**)
	--- (display only)	Generic probe A value	---	---	... (**)
Efe06/Efe07 (**)	Upper value	Generic probe A max. limit	30.0 barg (**)
	Lower value	Generic probe A min. limit	0.0 barg (**)
Efe16	Calibration	Generic probe A adjustment	0.0 barg (**)
	---	---	...
Efe16	DI	Generic digital input F DI position	---	---	---, 01...18, B1...B10 (****)
	Status (display only)	Status of generic digital input F DI	---	---	Closed / Open
Efe21	Logic	Logic of generic digital input F DI	NC	---	NC / NO
	Function (display only)	Status of generic digital input F DI	---	---	Not active / Active
Efe21	---	---	...
	DO	Generic stage 1 DO position	---	---	---, 01...29 (****)
Efe21	Status (display only)	Status of generic stage 1 DO	---	---	Closed / Open
	Logic	Logic of generic stage 1 DO	NO	---	NC / NO
Efe21	Function (display only)	Generic stage 1 DO function status	---	---	Not active / Active

Mask index	Display description	Description	Default	UOM	Values
...
Efe29	Modulating.1	Generic modulating 1 AO position	0	---	---, 01...06 (****)
	Type (****)	Type of output, PWM / phase control for generic modulating function 1 AO (line 1)	FCS1*-CON-VONOFF	---	FCS1*-CONVONOFF; "-----"; MCHRTF*"; FCS3*-CONV010"
	Status (display only)	Generic modulating 1 output value	0	%	0.0...100.0
Egaa01	DI	ChillBooster fault DI position (line 1)	---	---	---, 01...18, B1...B10 (****)
	Status (display only)	Status of ChillBooster fault DI (line 1)	---	---	Closed / Open
	Logic	Logic of ChillBooster fault DI (line 1)	NC	---	NC / NO
	Function (display only)	Status of ChillBooster fault (line 1)	---	---	Not active / Active
Egaa02	DO	ChillBooster DO position (line 1)	---	---	---, 01...29 (****)
	Status (display only)	Status of ChillBooster DO (line 1)	---	---	Closed / Open
	Logic	Logic of ChillBooster DO (line 1)	NO	---	NC / NO
	Function (display only)	Status of ChillBooster function (line 1)	---	---	Not active / Active
Egab01	Device present	Enable ChillBooster function (line 1)	NO	---	NO / YES
	Deactivation when fan-power falls under	Fan capacity under which ChillBooster is deactivated (line 1)	95	%	0...100
Egab02	Before the activation fans at max for	Fans work at maximum capacity at least for this time before ChillBooster activation (line 1)	5	min	0 to 300
	Ext.Temp.Thr.	Outside temperature threshold for ChillBooster activation (line 1)	30.0 °C (**)
Egab03	Sanitary proc. start at	Enable hygiene procedure (line 1)	Disab.	---	DISABLE / ENABLE
	Duration	Hygiene procedure starting time (line 1)	00:00	---	...
	Ext.temp.thr	Hygiene procedure duration (line 1)	0	min	0 to 30
		Outside temperature threshold for hygiene procedure activati. (line 1)	5.0 °C (**)
Egab04	ChillBooster requires maintenance after	ChillBooster maximum running time (line 1)	200	h	0...999
	Reset maintenance time	ChillBooster maintenance time reset (line 1)	NO	---	NO / YES
Ehb01	Avoid simultaneous pulses betw.lines	Enable simultaneous compressor start up inhibition	NO	---	NO / YES
	Delay	Delay between start up for compressors on different lines	0	s	0...999
Ehb03	Force off L2 Comp.s for line 1 fault	Enable line 2 compressor switch OFF due to line 1 compressor fault	NO	---	NO / YES
	Delay	Delay for line 2 compressor switch off after serious alarm on line 1 compressors	0	s	0...999
Ehb04	Switch on L1 Comp.s for L2 activation	Enable line 1 compressor switch ON due to line 2 compressor switch ON	NO	---	NO / YES
	Switch on period	Delay for line1 compressor switch on for line 2 compressor switch on	30	s	0...999
	Force off line 2 if line 1 is off	Enable line 2 compressor switch OFF due to line 1 switch OFF	NO	---	NO / YES
Ehb05	Enable min threshold for L1 activation	Enable L1 activation by DSS only when suction pressure is greater than a minimum threshold	NO	---	NO / YES
	Threshold	Minimum threshold for line 1 activation by DSS	--- (**)

The following parameters refer to line 2, for details see the corresponding parameters for line 1 above

Eaba04	---	Oil temperature probe position (line 2)	B1	---	---, B1...B10 (****)
	---	Oil temperature probe type (line 2)	4-20mA	---	---
	---	Oil temperature probe value (line 2)	--- (**)
	Upper value	Oil temperature probe max. limit (line 2)	30.0 barg (**)
	Lower value	Oil temperature probe min. limit (line 2)	0.0 barg (**)
	Calibration	Oil temperature probe adjustment (line 2)	0.0 barg (**)
Eabb04	Oil pumps number	Number of oil pumps for common oil cooler (line 2)	0	---	0 to 1 (digital input) 0 to 2 (Digital outputs)
	Enable Aout pump	Enable AO of common oil cooler pump (line 2)	YES	---	NO (Digital outputs) YES (digital input)
Ebba01	DO	Subcooling valve DO position (line 2)	---	---	---, 01...29 (****)
	Status (display only)	Status of subcooling valve DO (line 2)	---	---	Closed / Open
	Logic	Logic of subcooling valve (line 2)	NO	---	NC / NO
	Function (display only)	Subcooling valve function status (line 2)	---	---	Not active Active
Ebbb01	Subcooling control	Enable subcooling function (line2)	NO	---	NO / YES
	---	Subcooling control type (line 2)	COND&LIQUID TEMP.	---	COND&LIQUID TEMP. LIQUID TEMP. ONLY
	Threshold	Threshold for subcooling control (line 2)	0.0 °C	...	-9999.9...9999.9
	Subcool.value (display only)	Value of subcooling (line 2)	0.0 °C	...	-999.9...999.9
Eccb04	Economizer	Enable economizer function (line 2)	NO	---	NO / YES
	Compr.Power Thr.	Capacity percent threshold for economizer activation (line 2)	0	%	0...100
	Press.Lim.	Condensing temperature threshold for economizer activation (line 2)	0.0 °C	...	-999.9...999.9
	Disch.T.Thr.	Discharge temperature threshold for economizer activation (line 2)	0.0 °C	...	-999.9...999.9
Edba01	---	Compressor 1 discharge temperature probe position (line 2)	B1	---	---, B1...B10 (****)
	---	Compressor 1 discharge temperature probe type (line 2)	4-20mA	---	---
	---	Compressor 1 discharge temperature probe value (line 2)	--- (**)
	Upper value	Compressor 1 discharge temperature probe max. limit (line 2)	30.0 barg (**)
	Lower value	Compressor 1 discharge temperature probe min. limit (line 2)	0.0 barg (**)
	Calibration	Compressor 1 discharge temperature probe adjustment (line 2)	0.0 barg (**)

Mask index	Display description	Description	Default	UOM	Values
Edbb01	Liquid Injection	Enable liquid injection function (line 2)	DIS	---	DIS / EN
	Threshold	Liquid injection setpoint (line 2)	70.0 °C (**)
	Differential	Liquid injection differential (line 2)	5,0 (**)
...
Eeba02	DI	Heat recovery from digital input DI position (line 2)	---	---	---, 01...18, B1...B10 (****)
	Status	Status of heat recovery DI (line 2)	---	---	Closed / Open
	Logic	Logic of heat recovery DI (line 2)	NC	---	NC / NO
Eebb01	Function	Status of heat recovery from digital input DI function (line 2)	---	---	Not active / Active
	Enable Heat Reclaim	Enable heat recovery function (line 2)	NO	---	NO / YES
...
Egba01	DI	ChillBooster fault DI position (line 2)	---	---	---, 01...18, B1...B10 (****)
	Status	Status of ChillBooster fault DI (line 2)	---	---	Closed / Open
	Logic	Logic of ChillBooster fault DI (line 2)	NC	---	NC / NO
	Function	Status of ChillBooster fault DI (line 2)	---	---	Not active / Active
...
Egbb01	Device present	ChillBooster function enable (line 2)	NO	---	NO / YES
	Deactivation when fan-power falls under	Fans capacity under which ChillBooster is deactivated (line 2)	95	%	0...100
...

Mask index	Display description	Description	Default	UOM	Values
------------	---------------------	-------------	---------	-----	--------

 F.settings

Faaa01	Summer/Winter	Enable Summer/Winter period management (line 1)	NO	---	NO / YES
	Special days	Enable special days management (line 1)	NO	---	NO / YES
	Holiday periods	Enable holiday period management (line 1)	NO	---	NO / YES
Faaa02	Begin	Summer period beginning date (line 1)	---	---	01/Gen...31/Dic
	End	Summer period end date (line 1)	---	---	01/Gen...31/Dic
Faaa03	Day 01	Special day 1 date (line 1)	---	---	01/Gen...31/Dic
...
Faaa04	Day 10	Special day 10 date (line 1)	---	---	01/Gen...31/Dic
Faaa05	P1	Holiday period P1 beginning date (line 1)	---	---	01/Gen...31/Dic
	---	Holiday period P1 end date (line 1)	---	---	01/Gen...31/Dic

	P5	Holiday period P5 beginning date (line 1)	---	---	01/Gen...31/Dic
...	---	Holiday period P5 end date (line 1)	---	---	01/Gen...31/Dic
Faab01	Date format	Date format	DD/MM/YY	---	---- DD/MM/YY MM/DD/YY YY/MM/DD
	Hour	Hour and minute
Faab02/Faab03/ Faab04	Date	Date
	Day (display only)	Day of the week calculated from current date	Monday... Sunday
Faab05	Daily saving time	Enable daylight saving time	DISABLE	---	DISABLE ENABLE
	Transition time	Offset time	60	---	0 to 240
	Start, ...	Starting week, day and month and hour for daylight saving time
	End, ...	End week, day and month and hour for daylight saving time
Fb01	Language	Current language	ENGLISH	---	...
Fb02	Disable language mask at start-up	Disable the change language screen at start-up	YES	---	NO / YES
	Countdown	Starting value for countdown, time change language screen active.	60	s	0...60
Fb03	Main mask selection	Main screen selection	LINE 1	---	LINE 1 LINE 2 DOUBLE SUCTION DOUBLE CONDENSER
	Address	Address of the controller in a supervisory system network (line 1)	196	---	0 to 207
	Protocol	Supervisor communication protocol (line 1)	pRACK MANAGER	---	-- CAREL SLAVE LOCAL CAREL SLAVE REMOTE MODBUS SLAVE pRACK MANAGER CAREL SLAVE GSM
Fca01	Baudrate	Supervisor communication baud rate (line 1)	19200	---	1200 to 19200
	Insert password	Password	0000	---	0...9999
Fd01	Logged as (display only)	Current password level	---	---	User, Service, Manufacturer
Fd02	Logout	Logout	NO	---	NO / YES
Fd03	User	User password	0000	---	0...9999
	Service	Service password	1234	---	0...9999
	Manufacturer	Manufacturer password	1234	---	0...9999

The following parameters refer to line 2, for details see the corresponding parameters for line 1 above

Fcb01	Address	Enable summer/winter period management (line 2)	196	---	0 to 207
	Protocol	Enable special days management (line 2)	pRACK MANAGER	---	-- CAREL SLAVE LOCAL CAREL SLAVE REMOTE MODBUS SLAVE pRACK MANAGER CAREL SLAVE GSM
	Baudrate	Enable holiday period management (line 2)	19200	---	1200 to 19200

Mask index	Display description	Description	Default	UOM	Values
G. Safety					
Gba01	Prevent enable	Enable condensing pressure prevent (line 1)	NO	---	NO / YES
Gba02	Setpoint	Condensing pressure prevent threshold (line 1)	0.0 barg (**)
	Differential	Condensing pressure prevent differential (line 1)	0.0 barg	...	0.0 to 99.9
	Decrease compressor power time	Decreasing capacity time (line 1)	0	s	0...999
Gba03	Enable Heat Reclaim as first prevent step	Enabling heat recovery as first stage for condensing HP prevent (line 1)	NO	---	NO / YES
	Offset HeatR.	Offset between heat recovery and prevent setpoint (line 1)	0.0 barg	...	0.0 to 99.9
Gba04	Enable ChillBooster as first prevent step	Enable ChillBooster as first stage for condensing HP prevent (line 1)	NO	---	NO / YES
	Offset Chill.	Offset between ChillBooster and prevent setpoint (line 1)	0.0 barg	...	0.0 to 99.9
Gba05	Prevent max.num	Maximum number of prevent allowed before locking compressor (line 1)	3	---	1...5
	Prevent max.number evaluation time	Prevent maximum number evaluation time	60	h	0...999
	Reset automatic prevent	Reset number of prevent (line 1)	NO	---	NO / YES
Gca01	Common HP type	Type of reset for common HP alarm (line 1)	AUTO	---	AUTO MAN
	Common HP delay	Common high pressure delay (line 1)	10	s	0...999
Gca02	Common LP start delay	Low common condensing pressure delay at start up (line 1)	60	s	0...999
	Common LP delay	Low common condensing pressure delay during operation (line 1)	20	s	0...999
Gca03	Time of semi-automatic alarm evaluation	Period of LP evaluation (line 1)	120	min	0...999
	N° of retries before alarm becomes manual	Number of LP in period after which the alarm becomes manual (line 1)	5	---	0...999
Gca04	Liquid alarm delay	Liquid level alarm delay (line 1)	0	s	0...999
	Oil alarm delay	Common oil alarm delay (line 1)	0	s	0...999
Gca05	Output alarms relays activation with	Select alarm relay output activation for active alarms or alarms not reset	Active alarms		Active alarms Alarms not reset

The following parameters refer to line 2, for details see the corresponding parameters for line 1 above

Gbb01	Prevent enable	Enable condensing pressure prevent (line 2)	NO	---	NO / YES
...	---	...
Gcb01	Common HP type	Type of reset for common HP alarm (line 2)	AUTO	---	AUTO MAN
	Common HP delay	Common high pressure delay (line 2)	10	s	0...999
...	---	...

Mask index	Display description	Description	Default	UOM	Values
H. Info					
H01 (display only)	Ver.	Software version and date	...	---	...
	Bios	Bios version and date	...	---	...
	Boot	Boot version and date	...	---	...
H02 (display only)	Board type	Type of hardware	...	---	...
	Board size	Hardware size	...	---	...
	Total flash	Flash memory size	---	KB	...
	RAM	RAM size	---	KB	...
	Built-In type	Type of built-in display	---	---	None / PGD1
	Main cycle	Number of cycles per second and software cycle time	---	cycles/s ms	...

Mask index	Display description	Description	Default	UOM	Values	
I. Setup						
Ia01	Pre-configuration	Pre-configuration selected	01. RS2	---	--NOT USED-- 08. SL5d 01. RS2 09. SW1 02. RS3 10. SW2 03. RS3p 11. SW3 04. RS3i 12. d-RS2 05. RS4 13. d-RS3 06. RS4i 14. d-RS4 07. SL3d	
	Ia02 (disp. only)	Boards necessary	pLAN boards required for the selected pre-configuration	---	---	---
	Ia03 (disp. only)	Suction line	Number of suction lines featured in the pre-configuration	---	---	0 to 2
		Condenser line	Number of condenser lines featured in the pre-configuration	---	---	0 to 2
	Ia04 (display only)	Num.Comp. L1	Number of compressors featured in the pre-configuration (line 1)	...	---	1...12
		Comp.type L1	Type of compressors featured in the pre-configuration (line 1)	RECIPROCATING	---	RECIPROCATING / SCROLL SCREW
		Num.Comp. L2	Number of compressors featured in the pre-configuration (line 2)	...	---	1...12
Ia05 (display only)	Comp.type L2	Type of compressors featured in the pre-configuration (line 2)	RECIPROCATING	---	RECIPROCATING / SCROLL	
	Num.alarms per comp.	Number of alarms for compressor featured in the pre-configuration	1/4 (*)	---	0 to 4/7 (*)	
	Cond.Gen.Alarm	Enable common condenser alarm	EN	---	EN/DIS	
	HP comm.pressostat	Enable common HP pressure switch	EN	---	EN/DIS	
Ib01	LP comm.pressostat	Enable common LP pressure switch	EN	---	EN/DIS	
	Type of Installation	Type of system	SUCTION + CONDENSER	---	SUCTION / CONDENSER SUCTION + CONDENSER	
Ib02	Measure Units	Unit of measure	°C/barg	---	°C/barg / °F/psig	
Ib03	Compressors type	Type of compressors (line 1)	RECIPROCATING	---	RECIPROCATING SCROLL / SCREW	
	Compressors number	Number of compressors (line 1)	2/3 (*)	---	1...6/12 (*)	
Ib04	Number of alarms for each compressor	Number of alarms for each compressor (line 1)	1	---	0 to 4/7 (*)	

Mask index	Display description	Description	Default	UOM	Values
lb05	Modulate speed device	Modulating speed device for first compressor (line 1)	None	---	NONE / INVERTER ---/DIGITAL SCROLL(*) ---/STEPLESS*)
lb30	Compressors sizes	Compressors sizes (line 1)	SAME CAPACITY & SAME STAGE CONF.	---	SAME CAPAC&SAME STAGE CONF. SAME CAPAC.&DIFF. STAGE CONF. DEFINE SIZES
lb34	S1	Enable size and size for compressor group 1 (line 1)	YES 10.0	---	NO / YES 0.0...500.0
	---	---	---
lb34	S4	Enable size and size for compressor group 4 (line 1)	NO ---	---	NO / YES 0.0...500.0
	---	---	---
lb35	S1	Enable stages and stages for compressor group 1 (line 1)	YES 100	---	NO / YES 100; 50/100; 50/75/100; 25/50/75/100; 33/66/100
	---	---	---
lb35	S4	Enable stages and stages for compressor group 4 (line 1)	NO ---	---	NO / YES 100; 50/100; 50/75/100; 25/50/75/100; 33/66/100
	---	---	---
lb36	C01	Size group for compressor 1 (line 1) or presence of inverter	S1	---	S1...S4/INV
	---	---	---
lb36	C12	Size group for compressor 12 (line 1)	S1	---	S1...S4
	---	---	---
lb10	Compr.Manufacturer	Compressor manufacturer for screw compressors	Generic	---	GENERIC BITZER REFCOMP HANBELL
	Compressor series	Compressor series	... (***)	---	... (***)
lb11	Compressors sizes	Compressor sizes (line 1)	SAME CAPACITY	---	SAME CAPACITY / DEFINE SIZES
lb16	S1	Enable size and size for compressor group 1 (line 1)	YES ---	---	NO / YES 0.0...500.0
	---	---	---
lb16	S4	Enable size and size for compressor group 4 (line 1)	NO ---	---	NO / YES 0.0...500.0
	---	---	---
---	---	---	---	---	---
lb17	C01	Size group for compressor 1 (line 1) or presence of inverter	S1	---	S1...S4/INV
	---	---	---
lb17	C06	Size group for compressor 12 (line 1)	---	---	S1...S4
	---	---	---
lb20	Compressors sizes	Compressors sizes (line 1)	SAME CAPACITY	---	SAME CAPACITY / DEFINE SIZES
lb21	S1	Enable size and size for compressor group 1 (line 1)	YES ---	---	NO / YES 0.0...500.0
	---	---	---
lb21	S4	Enable size and size for compressor group 4 (line 1)	NO ---	---	NO / YES 0.0...500.0
	---	---	---
lb22	C01	Size group for compressor 1 (line 1) or presence of inverter	S1	---	S1...S4/INV
	---	---	---
lb22	C12	Size group for compressor 6 (line 1)	S1	---	S1...S4
	---	---	---
lb40	Regulation by	Compressor control by temperature or pressure (line 1)	PRESSURE	---	PRESSURE / TEMPERATURE
	Measure unit	Unit of measure (line 1)	barg	---	---
	Refrigerant	Type of refrigerant (suction Line 1)	R404A	---	R22 - R134a - R404A - R407C - R410A - R507A - R290 - R600 - R600a - R717 -R744 - R728 - R1270 - R417A - R422D -R413A - R422A - R423A - R407A - R427A - R245Fa - R407F - R32
lb41	Regulation type	Compressor control type (line 1)	NEUTRAL ZONE	---	PROPORTIONAL BAND NEUTRAL ZONE
	Enable integral time action	Enable integral time for proportional suction line control (line 1)	NO	---	NO / YES
lb42	Setpoint	Setpoint without compensation (suction line 1)	3,5 barg	... (**)	... (**)
	Differential	Differential (suction line 1)	0,3 barg	... (**)	... (**)
lb43	Configure another suction line	Second suction line configuration	NO	---	NO / YES
lb45	Dedicated pRack board for suction line	Suction lines on different boards	NO	---	NO / YES
lb50	Compressors type	Type of compressors (line 2)	RECIPROCATING	---	RECIPROCATING / SCROLL
	Compressors number	Number of compressors (line 2)	3	---	1...12
lb51	Number of alarms for each compressor	Number of alarms for each compressor (line 2)	1	---	0 to 4
lb52	Modulate speed device	Modulating speed device for first compressor (line 2)	NONE	---	NONE INVERTER ---/DIGITAL SCROLL(*)
lb70	Compressors sizes	Compressors sizes (line 1)	SAME CAPACITY	---	SAME CAPAC.&SAME STAGE CONF. SAME CAPAC.&DIFF. STAGE CONF. DEFINE SIZES
lb74	S1	Enable size and size for compressor group 1 (line 1)	YES ---	---	NO / YES 0.0...500.0
	---	---	---
lb74	S4	Enable size and size for compressor group 4 (line 1)	NO ---	---	NO / YES 0.0...500.0
	---	---	---

Mask index	Display description	Description	Default	UOM	Values
lb75	S1	Enable stages and stages for compressor group 1 (line 1)	YES 100	---	NO / YES 100; 50/100; 50/75/100; 25/50/75/100; 33/66/100
	---	---	---
lb76	S4	Enable stages and stages for compressor group 4 (line 1))	NO ---	---	NO / YES S1...S4
	---	---	---
lb60	C01	Size group for compressor 1 (line 1) or presence of inverter	S1	---	S1...S4/INV
	---	---	---
lb61	C12	Size group for compressor 6 (line 1)	S1	---	S1...S4
	Compressors sizes	Compressors sizes (line 1)	SAME CAPACITY	---	SAME CAPACITY DEFINE SIZES
lb62	S1	Enable size and size for compressor group 1 (line 1)	YES ---	---	NO / YES 0.0...500.0
	---	---	---
lb62	S4	Enable size and size for compressor group 4 (line 1)	NO ---	---	NO / YES 0.0...500.0
	---	---	---
lb80	C01	Size group for compressor 1 (line 1) or presence of inverter	S1	---	S1...S4/INV
	---	---	---
	C12	Size group for compressor 6 (line 1)	S1	---	S1...S4
lb81	Regulation by	Compressor control by temperature or pressure (line 1)	PRESSURE	---	PRESSURE / TEMPERATURE
	Measure unit	Unit of measure (line 1)	barg	---	---
	Refrigerant	Type of refrigerant (suction Line 1)	R404A	---	R22 - R134a - R404A - R407C - R410A - R507A - R290 - R600 - R600a - R717 -R744 - R728 - R1270 - R417A - R422D -R413A - R422A - R423A - R407A - R427A - R245Fa - R407F - R32
lb82	Regulation type	Compressor control type (line 1)	NEUTRAL ZONE	---	PROPORTIONAL BAND NEUTRAL ZONE
	Enable integral time action	Enable integral time for proportional suction line control (line 2)	NO	---	NO / YES
lb82	Setpoint	Setpoint without compensation (suction line 2)	3.5 barg	... (**)	... (**)
	Differential	Differential (suction line 2)	0.3 barg	... (**)	... (**)
lb90	Dedicated pRack board for condenser line	Suct.line(s) and cond.line(s) on different boards, that is, condenser line(s) on dedicated board	NO	---	NO / YES
lb91	Fans number	Number of fans (line 1)	3	---	0 to 16
lb92	Modulate speed device	Fan modulating speed device (line 1)	NONE	---	NONE INVERTER PHASE CONTROL
lb93	Regulation by	Fans control by temperature or pressure value (line 1)	PRESSURE	---	PRESSURE / TEMPERATURE
	Measure unit	Unit of measure (line 1)	barg	---	---
	Refrigerant	Type of refrigerant (condenser line 1)	R404A	---	R22 - R134a - R404A - R407C - R410A - R507A - R290 - R600 - R600a - R717 -R744 - R728 - R1270 - R417A - R422D -R413A - R422A - R423A - R407A - R427A - R245Fa - R407F - R32
lb94	Regulation type	Fan control type (line 1)	PROPORTIONAL BAND	---	PROPORTIONAL BAND NEUTRAL ZONE
	Enable integral time action	Enable integral time for proportional band control	NO	---	NO / YES
lb95	Setpoint	Setpoint without compensation (condenser line 1)	12,0 barg	... (**)	... (**)
	Differential	Differential (condenser line 1)	2,0 barg	... (**)	... (**)
lb96	Configure another condensing line	Second condenser line configuration	NO	---	NO / YES
lb1a	Fans number	Number of fans (line 2)	3	---	0...16
...	---	---	---
lb1e	Differential	Differential (condenser line 2)	2,0 barg	... (**)	... (**)
lc01	Type of Installation	Type of plant	SUCTION + CONDENSER	---	SUCTION CONDENSER SUCTION + CONDENSER
lc02	Measure Units	Unit of measure	°C/barg	---	°C/barg / °F/psig
lc03	Number of suction lines	Number of suction lines	1	---	0...2
lc04	Dedicated pRack board for suction line	Suction lines are on different boards	NO	---	NO / YES
lc05	Compressors type	Type of compressors (line 1)	RECIPROCATING	---	RECIPROCATING / SCROLL SCREW
	Compressors number	Number of compressors (line 1)	4	---	1...6/12 (*)
lc06	Compressors type	Type of compressors (line 2)	RECIPROCATING	---	RECIPROCATING / SCROLL SCREW
	Compressors number	Number of compressors (line 2)	0	---	1...6
lc07	Number of condensing lines	Number of condenser lines in the system	1	---	0...2
lc08	Line 1	Number of fans (line 1)	4	---	0...16
	Line 2	Number of fans (line 2)	0	---	0...16
lc09	Dedicated pRack board for condenser line	Condenser lines are on different boards	NO	---	NO / YES
lc10 (display only)	Boards necessary	pLAN boards required for the selected pre-configuration	---	---	---
ld01	Save configuration	Save Manufacturer configuration	NO	---	NO / YES
	Load configuration	Manual installation of Manufacturer configuration	NO	---	NO / YES
ld02	Restore Carel default	Manual installation of Carel default values	NO	---	NO / YES

Tab. 7.a

(*) Depending on the type of compressor
 (***) Depending on the unit of measure selected
 (***) Depending on the compressor manufacturer, see relative paragraph
 (****) Depending on the hardware size

8. ALARMS

pRack PR100 can manage both alarms relating to the status of the digital inputs and to operation of the system. For each alarm, the following are controlled:

- The actions on the devices, if necessary
- The output relays (one global and two with different priorities, if configured)
- The red LED on the terminal and the buzzer, where present
- The type of acknowledgement (automatic, manual, semiautomatic)
- Any activation delay

The complete list of alarms, with the related information as described above, is available in Appendix A.4.

8.1 Alarm management

All alarms feature the following behaviour:

- When an alarm is activated, the red LED flashes and the buzzer is activated (where present); the output relays corresponding to the global alarm and to any alarms with priority are activated (if configured)
- Pressing the  (Alarm) button, the red LED stays on steady, the buzzer is muted and the alarm screen is shown
- If there is more than one active alarm, these can be scrolled using  (Up)  (Down). This condition is signalled by an arrow at the bottom right of the screen
- Pressing the  (Alarm) button again for at least 3 seconds acknowledges the alarms manually, and these are cleared from the display unless others are active (they are saved in the log)

8.1.1 Priority

For certain alarms, the alarm output relay can be set with two types of priority:

- R1: serious alarm
- R2: normal alarm

The corresponding relays, once configured, are activated when an alarm with the corresponding priority occurs.

For the other alarms, the priority is fixed and is associated by default with one of the two relays.

8.1.2 Acknowledgement

The alarms can have manual, automatic or semiautomatic acknowledgement:

- Manual: the alarm is acknowledged by pressing the  (Alarm) button twice, the first time displays the corresponding alarm screen and mutes the buzzer, the second (extended, for at least 3 seconds) cancels the alarm (which is saved in the log). If the alarm is still active, acknowledgement has no effect and the signal is shown again.
- Automatic: when the alarm condition ceases, the alarm is automatically reset, the LED comes on steady and the corresponding screen remains displayed until the  (Alarm) button is pressed and held; the alarm is saved in the log.
- Semiautomatic: acknowledgement is automatic, until a maximum number of activations in set time. If the number reaches the maximum set, acknowledgement becomes manual.

For manual acknowledgement, the functions associated with the alarm are not reactivated until acknowledgement has been completed, while for automatic acknowledgement they're reactivated as soon as the alarm condition ceases.

8.1.3 Log

The alarm log can be accessed:

- from branch G.a of the main menu
- by pressing the  (Alarm) button and then  (Enter) when there are no active alarms
- by pressing  (Enter) after having scrolled all the alarms.

The alarm log screens show:

1. Order of activation (no. 01 is the oldest alarm)
2. Hour and date the alarm was activated
3. Short description
4. Main values recorded at the moment the alarm was activated (suction pressure and condensing pressure)

 **Note:** A maximum of 50 alarms can be logged; after this limit any new events overwrite the oldest ones, which are therefore deleted.

8.2 Compressor alarms

The number of alarms for each compressor can be set during the configuration phase using the Wizard or subsequently from branch C.a.e/ C.b.e of the main menu. The number of alarms is the same for all the compressors on the same line.

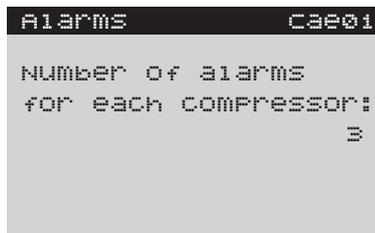

Fig. 8.a

 **Note:** The maximum number of alarms that can be configured for each compressor depends not only on the type of compressor, but also on the size of pRack and the number of compressors fitted.

After having selected the number of alarms (maximum 4 for the reciprocating or scroll compressors and 7 for screw compressors), the settings can be configured for each alarm, choosing a description from the options shown in the table, the output relay, the type of reset, delay and priority. The effect of the alarm on the devices is set and involves stopping the compressor, except for the oil warning.

Possible descriptions for compressor alarms

Reciprocating or scroll	Screw
Generic	Generic
Overload	Overload
High pressure	High pressure
Low pressure	Low pressure
Oil	Oil
	Screw rotation
	Oil warning (Filter Blocked)

Tab. 8.a

An example of a screen for selecting the description of the alarm is shown in the figure:

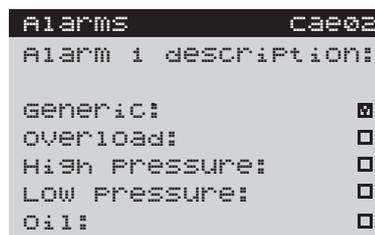

Fig. 8.b

After having selected the 'generic' description, no other description can be selected. In general, the descriptions are divided into four groups:

- generic
- others (overload, oil, high pressure , low pressure)
- screw rotation
- oil warning

After a description has been selected for a certain group, descriptions from a different group can not be selected for that alarm.

For example, generic only, or overload + oil, or rotation only or overload + high pressure, etc. can be selected.

Each alarm will have one alarm screen, which will show all the descriptions associated to that alarm.

Based on the number of alarms selected, the descriptions associated by default are shown in the table below

Default descriptions based on the number of alarms

Number of alarms	Descriptions
1	Generic
2	Overload HP-LP
3	Overload HP-LP Oil
4	Overload HP LP Oil
5	Overload HP LP Oil Oil warning
6	Overload HP LP Oil Oil warning Rotation
7	Overload HP LP Oil Oil warning Rotation Generic

Tab. 8.b

Note: for oil alarms, special management is available whereby the alarm is interpreted as an oil level alarm. When the alarm is activated, a number of attempts are made to restore the level for a set time before the alarm is signalled and the compressor stopped; see paragraph 6.6.1 for details.

If a modulating device is used for the compressors, further alarms become available:

- compressor inverter warning, common for the entire suction line, when the device is an inverter
- oil sump temperature alarm, high discharge temperature and oil dilution, for Digital Scroll™ compressors

For each compressor, two alarm variables are sent to the supervisor, one for each priority. As well as the alarm signal, the description of the alarm is also sent to the supervisor, using the values shown in the table:

The supervisor can interpret the variables sent by pRack PR100 and provide the correct description of the alarm.

8.3 Pressure and prevent alarms

pRack PR100 can manage pressure alarms from a pressure switch or probe, according to the following diagram.

Alarms from pressure switch:

- Low suction pressure
- High condensing pressure

Alarms from probe:

- Low suction pressure
- High suction pressure
- Low condensing pressure
- High condensing pressure

One possible example for the low pressure alarms is shown in the figure:

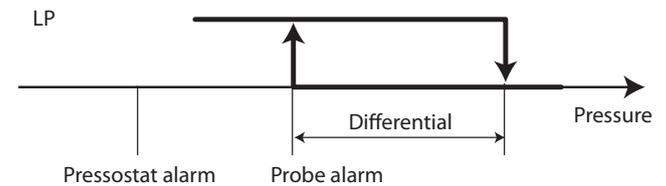

Fig. 8.c

In addition, the high pressure alarm features a prevent function, available by manually overriding the devices as well as using additional functions, such as heat recovery and ChillBooster.

Operation of the alarms and prevent function is described below.

8.3.1 Pressure alarms from pressure switch

The parameters corresponding to these alarms can be set in branch G.c.a/G.c.b of the main menu.

Low suction pressure from pressure switch

The low suction pressure alarm from pressure switch has the effect of stopping all the compressors without observing the various times, therefore when the digital input configured as low pressure switch is activated, all the compressors on the line affected are stopped immediately.

This alarm features semiautomatic reset, and both the monitoring time and the number of activations in the specified period can be set. If the number of activations is higher, reset becomes manual.

In addition, the delay after which the alarm is activated on both start-up and during operation can be set.

The delay at start-up only applies to unit start-up and not compressor power-up.

High condensing pressure from pressure switch

The high condensing pressure alarm from pressure switch has the effect of stopping all the compressors without observing the various times and forcing the fans on at maximum speed, therefore when the digital input configured as high pressure switch is activated, all the compressors on the line affected are stopped immediately and the fans operate at maximum output.

This alarm features manual or automatic reset, as configured by the user. The delay after which the alarm is activated can also be set

8.3.2 Pressure alarms from probe

The parameters corresponding to these alarms can be set in branch C.a.e/C.b.e of the main menu for the suction pressure and D.a.e/D.b.e for the condensing pressure.

For these types of alarms, reset is automatic and the activation threshold and differential can be set, as well as the type of threshold, which may be absolute or relative to the control set point. The figure shows an example of setting the threshold to relative.

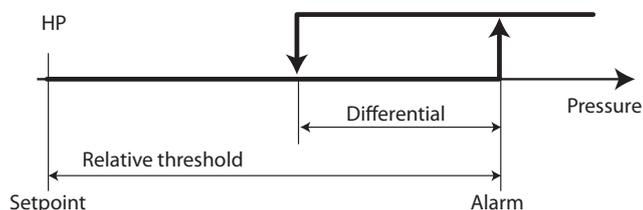

Fig. 8.d

Note: for temperature control, the alarms from probe are managed based on temperature even when pressure probes are fitted.

The effects of the different pressure alarms from probe are described below.

Low suction pressure from probe

The low suction pressure alarm from probe has the effect of stopping all the compressors, ignoring the times.

High suction pressure from probe

The high suction pressure alarm from probe has the effect of forcing all the compressors on, ignoring the control times, but observing the compressor protection times.

Low condensing pressure from probe

The low condensing pressure alarm from probe has the effect of stopping all the fans, ignoring the times.

High condensing pressure from probe

The high condensing pressure alarm from probe has the effect of forcing all the fans on and stopping all the compressors, ignoring the times.

8.3.3 High pressure prevention

pRack PR100 can manage 3 types of high condensing pressure prevention actions, involving:

- overriding the compressors and fans
- activating heat recovery
- activating ChillBooster

Prevent by overriding the compressors and fans

The parameters relating to this function can be set in branch G.b.a/G.b.b of the main menu.

The effect of this type of prevent action is to force all the fans on at maximum and switch all the compressors off, except for the minimum capacity stage, ignoring the control times but observing the compressor protection times. The minimum capacity stage means one compressor in the case of compressors without capacity control and modulation devices, or the minimum capacity stage for capacity-controlled compressors (e.g. 25%), or alternatively the minimum output of the modulation device in the case of inverters, Digital Scroll™ compressors or screw compressors with continuous modulation.

As well as the activation threshold, which is always absolute, and the activation differential, a compressor deactivation time can be set, corresponding to the time needed to switch off all the compressors, except for the minimum capacity stage.

In addition, both the monitoring time and the number of activations in the specified period can be set. If the number of activations is higher, reset becomes manual.

Prevent by activating heat recovery

The parameters corresponding to this function can be set in branch G.b.a/G.b.b of the main menu, if the heat recovery function is present.

As well as enabling the function, an offset from the activation threshold for the prevent by overriding devices function must be set. The activation differential for this function is the same as set for the prevent by overriding devices function.

When reaching the threshold, pRack PR100 activates the heat recovery function, if the conditions allow; see paragraph 6.6.3 for details.

Prevent by activating ChillBooster

The parameters relating to this function can be set in branch G.b.a/G.b.b of the main menu, if the ChillBooster function is present.

As well as enabling the function, an offset from the activation threshold for the prevent by overriding devices function must be set. The activation differential for this function is the same as set for the prevent by overriding devices function.

When reaching the threshold, pRack PR100 force activates the ChillBooster, if the conditions allow; see paragraph 6.6.5 for details.

The following figure illustrates the activation thresholds for the prevent function and the safety devices:

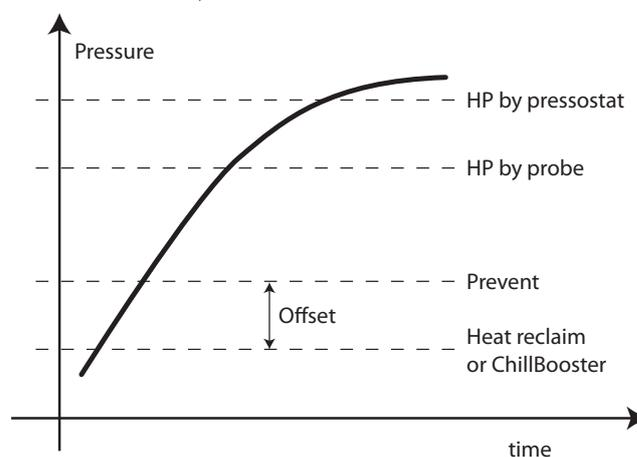

Fig. 8.e

9. SUPERVISORY AND COMMISSIONING SYSTEMS

pRack PR100 can be connected to various supervisory systems, specifically the Carel and Modbus communication protocols can be used. For the Carel protocol, the PlantVisor PRO and PlantWatch PRO models are available.

In addition, pRack PR100 can be connected to the pRack Manager commissioning software.

9.1 PlantVisor PRO and PlantWatch PRO supervisory systems

Connection to Carel PlantVisor PRO and PlantWatch PRO supervisory systems uses the RS485 card already fitted on some models of pRack PR100. For details on the models of card available, see Chapter 1.

Note: In general, the pRack boards that manage the suction lines must be fitted with the supervisor connection card, consequently boards with pLAN address 1 or 2.

Three different models of PlantVisor PRO and PlantWatch PRO are available, used to supervise system configurations with one or two lines:

- L1 – one line: can be used for system configurations with just one suction and/or condenser line.
- L2 – one line: can be used for system configurations with two suction and/or condenser lines, and the two suction lines are managed by separate boards.
- Two lines: can be used for system configurations with two suction and/or condenser lines, and the two suction lines are managed by the same board.

Important: model L2 – One line must be used only in association with model L1 – One line. For supervision of system configurations with just one line only model L1 – One line can be used.

Tutorial: the rule applied for using the models is summarised below:

- cconfiguration with board with pLAN address 2 → separate models
- configuration without board with pLAN address 2 → one model only

A connection example for using PlantVisor PRO and PlantWatch PRO is shown in the figure.

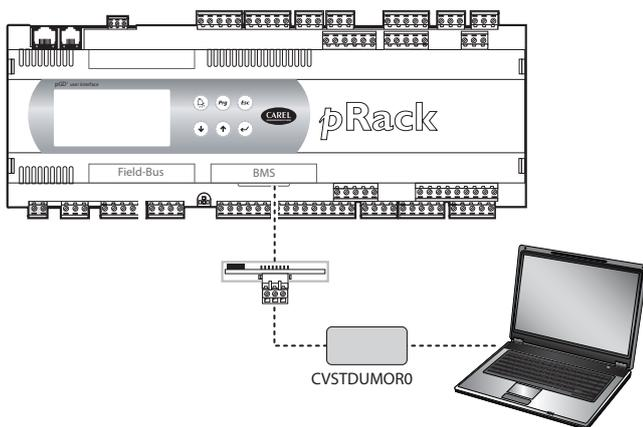

Fig. 9.a

The complete list of supervisor variables, with the corresponding addresses and descriptions, can be supplied upon request.

9.2 Commissioning software

pRack Manager is configuration and real-time monitoring software used to check the operation of pRack PR100, for commissioning, debug and maintenance operations.

The software is available on the internet at <http://ksa.CAREL.com> in the section "download à support à software utilities". The installation includes, in addition to the program, the user manual and the necessary drivers.

pRack Manager can be used to set the configuration parameters, modify the values of volatile and permanent variables, save graphs of the main system values to file, manually manage the unit I/Os using simulation files and monitor/reset alarms on the unit where the device is installed.

pRack PR100 is able to virtualise all the inputs and outputs, both digital and analogue, therefore each input and output can be overridden by pRack Manager.

pRack Manager manages <file name>.DEV files that contain the user parameter configurations and that can be downloaded from the pRack PR100 board and then subsequently uploaded.

To use the pRack Manager program, a serial converter output RS485 with CVSTDUTLFO (telephone connector) or CVSTDUMORO (3 pin terminal) must be connected to the board.

The connection to pRack Manager can be made:

1. Via the RS485 serial port used for the "pLAN" connection
2. Via the BMS serial port with RS485 serial card and activating the pRack Manager protocol by parameter on screen Fca01 or connecting pRack Manager and selecting SearchDevice = Auto (BMS or FB) on the "Connection settings" tab. In this case, the connection is established after around 15-20 seconds.

Important: the BMS serial port should only be used for monitoring the variables, while to update the software use the RS485 serial port dedicated to the pLAN connection.

The following figure shows an example of connection to the PC via the RS485 serial port used for the "pLAN" connection

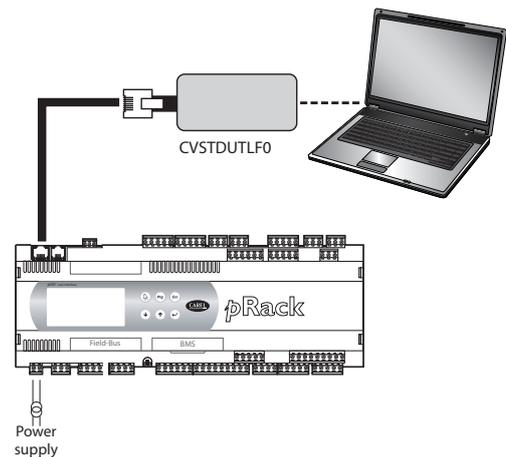

Fig. 9.b

Note: for further details see the pRack Manager program online help.

10. UPDATING THE SOFTWARE

The pRack PR100 boards are supplied with the software already loaded. If an update is required, the following can be used:

- pRack Manager
- SmartKey programming key

Note: The pRack PR100 software is protected by digital signature and cannot be loaded onto hardware other than pRack PR100 (e.g. pCO3), otherwise after 5 minutes of operation the software locks up, all the relays open and the warning "INVALID OEM IDENTIFIER" is shown.

The update files are available at <http://ksa.CAREL.com>.

Important: each version of the pRack PR100 software is associated with a specific controller firmware version (BIOS), therefore if updating the version, always check and where necessary update the BIOS on the board. The appropriate BIOS version is supplied together with the pRack pR100 update files.

10.1 Updating using pRack Manager

The software resident in the pRack PR100 boards can be updated from a PC.

For the connection procedure see Chapter 9, while for further details see the pRack Manager program online help.

Note: The pCOload program can also be used to update the pRack PR100 software, however Winload cannot be used.

10.2 Updating using SmartKey

The SMARTKEY programming key can copy the contents of one pRack PR100 board to another identical board, using the telephone connector on the terminal (the pLAN must be disconnected).

From a PC, with the SmartKey Programmer software running, the key can be configured to perform specific operations: acquire log files, program applications, etc.

The SmartKey Programmer software is installed together with pRack Manager.

The following figure shows the connection of the SmartKey to the PC using the PCOS00AKY0 converter.

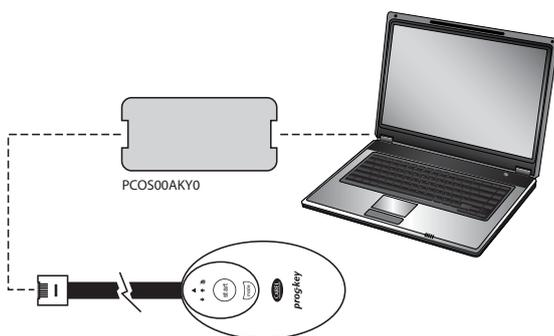

Fig. 10.a

Note: for further details on using the SmartKey, see the corresponding instruction sheet. For details on the SmartKey Programmer see the online manual.

10.3 Saving parameters between different software versions

The configuration parameters can be saved and loaded after having updated the software. The update requires the files relating to the new version being loaded (files with the following extensions: .iup, .blx., .blb, .grt, .dev) and the connection files (files with the following extensions: .2cf, .2ct, .2cd) for the installed version and the new version.

The connection files must be copied to the "2cf" directory under pRack Manager, for example C:\Program Files\CAREL\pRackManager\2cf.

The update procedure including saving the parameters is as follows (for details on the functions of the pRack Manager software see the online manual):

1. Switch the unit off from the user terminal or supervisor or digital input
2. Connect the PC where pRackManager is installed using the pLAN serial (disconnect the terminal if necessary) and disconnect any BMS connections
3. Start the pRack Manager software
4. In the "Connection settings" panel, set Baud rate to "Auto" and SearchDevice to "Auto (pLAN)" and select the COM port under PortNumber (if necessary, use the Wizard to detect the correct COM)
5. In Commissioning/Settings select the .2cf file relating to the version on pRack PR100, e.g. 1.0
6. Power down pRackPR100, power up again and wait for the controller to come "On line"
7. In Device Configuration read all the variables and save them to a .txt file (required)
8. Update the software version on pRackPR100, selecting from pRackLoad the following update files and selecting "Update graphic resources and "Enable zipped upload":
 - .iup (maximum 2 files)
 - .blx
 - .blb
 - ClearAllx.dev, where x is the pLAN address of the board being updated
9. Wait for the update procedure to end.
10. Power down, disconnect the PC and if necessary reconnect the terminal
11. Power up again and run a quick start-up procedure (pre-configurations or Wizard, confirming the default parameters)
12. Power down
13. Reconnect pRack Manager and power up again
14. In Commissioning/Settings select the .2cf file relating to the new version now loaded on pRack

Important: if using the BMS serial port to read/write variables, pRack pR100 continues operating, and therefore software malfunctions may occur. Consequently, use the RS485 serial port provided for the pLAN connection when carrying out the software update operations described above.

Note: to update the software without maintaining the parameter configuration, simply complete steps 1 to 4 and 8 to 10 in the previous procedure. In this case, the unit will need to be reconfigured using the complete start-up procedure.

11. APPENDIX

A.1 System configurations available

The system configurations available are shown in the table:

System configurations:

Configuration number	Description	Suction lines	Condenser lines	Compressors L1/L2	Maximum number of compressors per line L1/L2	Units present in pLAN (in addition to the terminal)	Reference diagram
1	No suction line, one condenser line	0	1	-	-	1	a
2	No suction line, two condenser lines	0	2	-	-	1	a
3	1 suction line (scroll or piston compressors), no condenser line	1	0	scroll, piston	12	1	a
4	1 suction line (scroll or piston compressors), 1 condenser line	1	1	scroll, piston	12	1	a
5	1 suction line (scroll or piston compressors), 1 condenser line on a separate board	1	1	scroll, piston	12	1, 3	b
6	2 suction lines on the same board (scroll or piston compressors), no condenser line	2	0	scroll, piston/scroll, piston	12/12	1	c
7	2 suction lines on the same board (scroll or piston compressors), 1 condenser line	2	1	scroll, piston/scroll, piston	12/12	1	c
8	2 suction lines on the same board (scroll or piston compressors), 1 condenser line on a separate board	2	1	scroll, piston/scroll, piston	12/12	1, 3	e
9	2 suction lines (scroll or piston compressors), 2 condenser lines on the same board	2	2	scroll, piston/scroll, piston	12/12	1	f
10	2 suction lines on the same board (scroll or piston compressors), 2 condenser lines on separate boards	2	2	scroll, piston/scroll, piston	12/12	1, 3	g
11	2 suction lines on separate boards (scroll or piston compressors), 1 condenser line on suction line 1 board	2	1	scroll, piston/scroll, piston	12/12	1, 2	h
12	2 suction lines on separate boards (scroll or piston compressors), 1 condenser line on a separate board	2	1	scroll, piston/scroll, piston	12/12	1, 2, 3	d
13	2 suction lines on separate boards (scroll or piston compressors), 2 condenser lines (one for each suction line board)	2	2	scroll, piston/scroll, piston	12/12	1, 2	h
14	2 suction lines on separate boards (scroll or piston compressors), 2 condenser lines on separate boards	2	2	scroll, piston/scroll, piston	12/12	1, 2, 3, 4	i
15	1 suction line (up to 2 screw compressors), no condenser line	1	0	screw	2	1	a
16	1 suction line (up to 2 screw compressors), 1 condenser line	1	1	screw	2	1	a
17	1 suction line (up to 2 screw compressors), 1 condenser line on a separate board	1	1	screw	2	1, 3	b
18	2 suction lines on separate boards (up to 2 screw compressors on line 1 and scroll or piston compressors on line 2), 1 condenser line on suction line 1 board	2	1	screw/scroll, piston	2/12	1, 2	h
19	2 suction lines on separate boards (up to 2 screw compressors on line 1 and scroll or piston compressors on line 2), 1 condenser line on a separate board	2	1	screw/scroll, piston	2/12	1, 2, 3	d
20	2 suction lines on separate boards (up to 2 screw compressors on line 1 and scroll or piston compressors on line 2), 2 condenser lines (one for each suction line board)	2	2	screw/scroll, piston	2/12	1, 2	h
21	2 suction lines on separate boards (up to 2 screw compressors on line 1 and scroll or piston compressors on line 2), 2 condenser lines on separate boards	2	2	screw/scroll, piston	2/12	1, 2, 3, 4	i
22	2 suction lines on separate boards (scroll or piston compressors), 2 condenser lines (line 1 on separate board, line 2 on board in common with suction)	2	2	scroll, piston/scroll, piston	2/12	1, 2, 3, 4	l

Tab. A.a

The system configurations available refer to the following diagrams:

- a. up to 1 suction line (scroll or piston compressors) and up to 1 condenser line on just one pRack PR100 board:

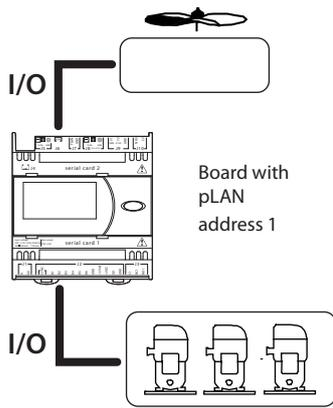

Fig. A.a

- b. 1 suction line (scroll or piston compressors) and 1 condenser line on a separate board:

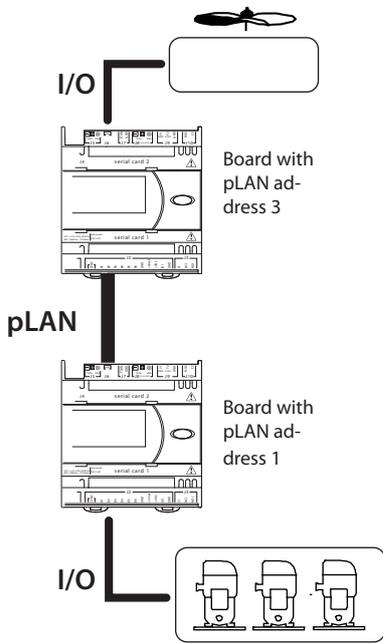

Fig. A.b

- c. 2 suction lines on the same board (scroll or piston compressors) and up to 1 condenser line:

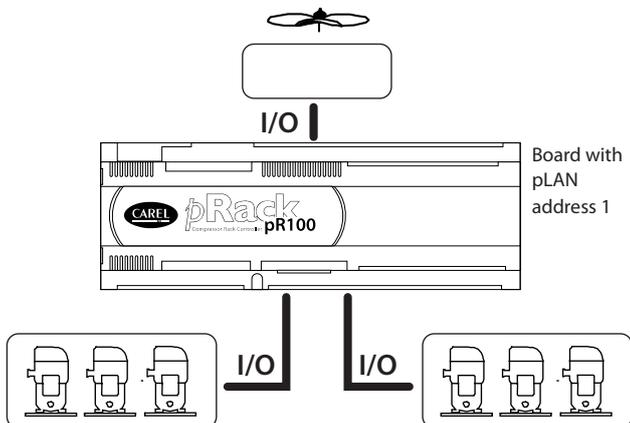

Fig. A.c

- d. 2 suction lines on separate boards (up to 2 scroll compressors on line 1 and scroll or piston compressors on line 2), 1 condenser line on a separate board:

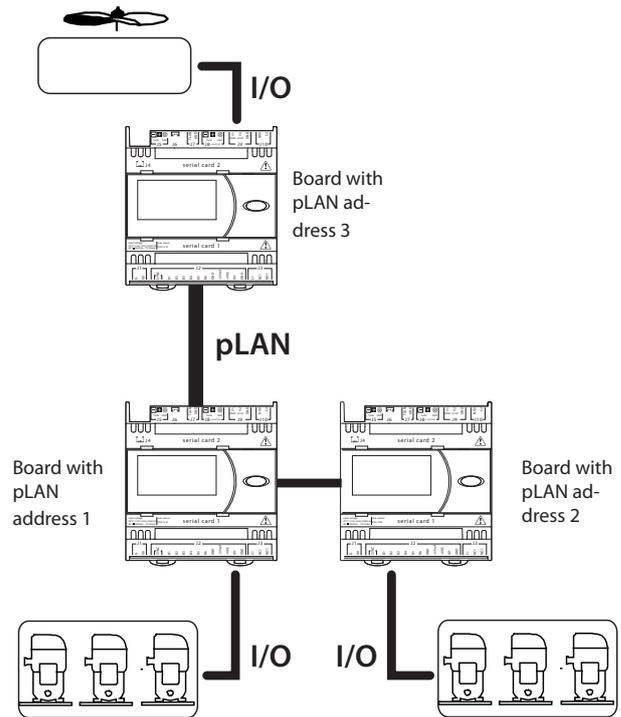

Fig. A.d

- e. 2 suction lines on the same board (scroll or piston compressors), 1 condenser line on a separate board:

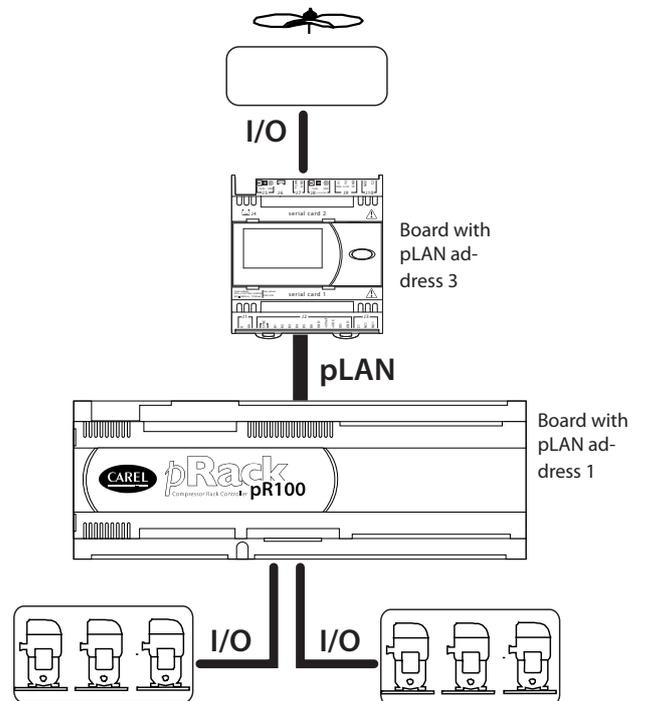

Fig. A.e

- f. 2 suction lines (scroll or piston compressors), 2 condenser lines on the same board:

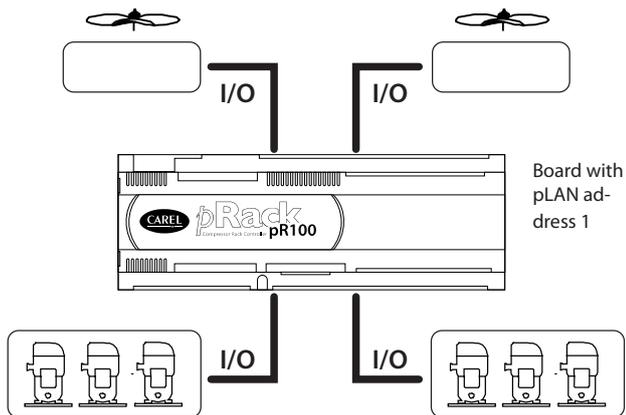

Fig. A.f

- g. 2 suction lines on the same board (scroll or piston compressors), 2 condenser lines on separate boards:

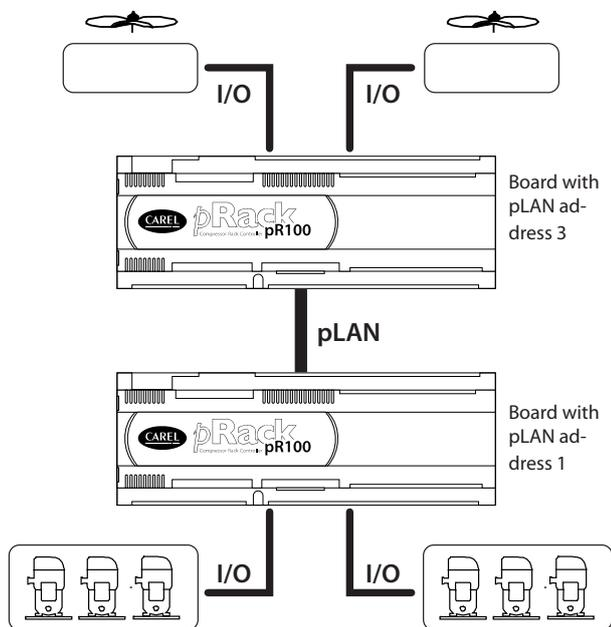

Fig. A.g

- h. 2 suction lines on separate boards (scroll or piston compressors), 2 condenser lines (one for each suction line board)

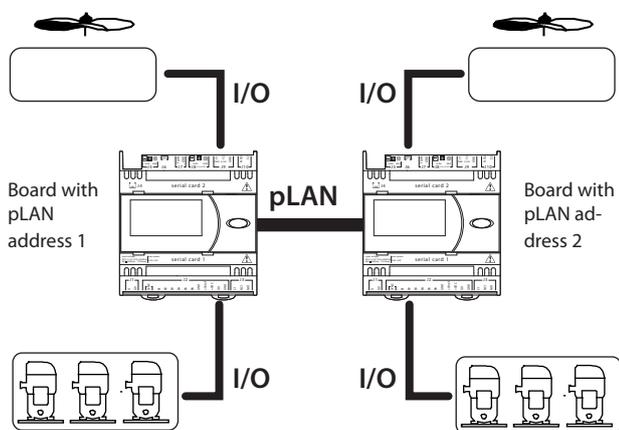

Fig. A.h

- i. 2 suction lines on separate boards (scroll or piston compressors), 2 condenser lines on separate boards

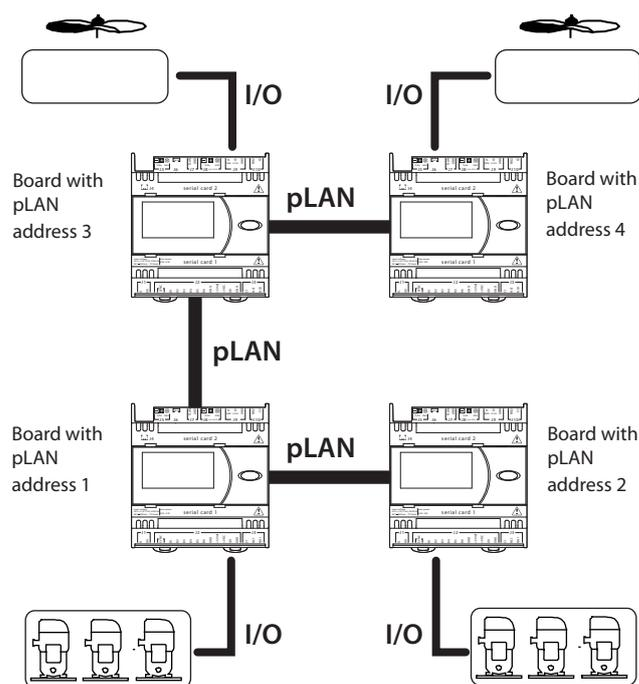

Fig. A.i

- j. 2 suction lines on separate boards (scroll or piston compressors), 2 condenser lines (line 1 on separate board, line 2 on common board with suction)

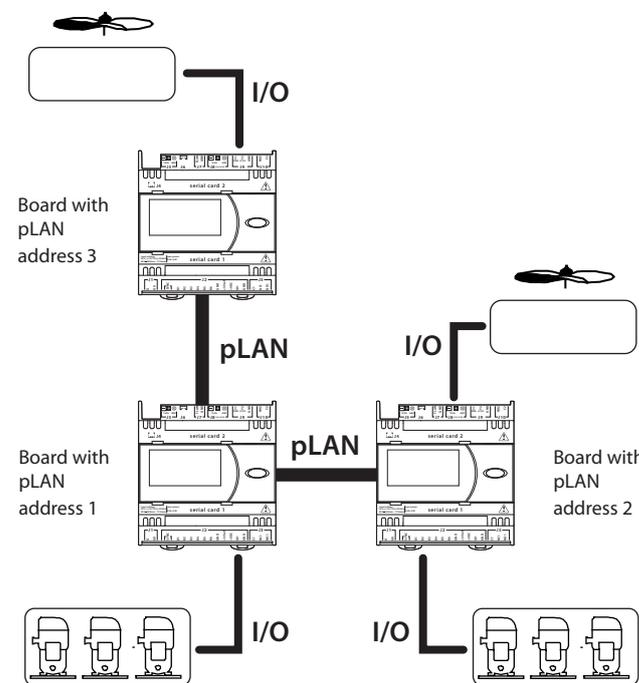

Fig. A.j

A.2 System configurations with more than one pLAN board

If the system configuration involves the connection of more than one board in a pLAN, the addresses must be set correct before select a solution of configuration.

For the addresses to be assigned to the pRack PR100 boards see Appendix A.1.

pRack PR100 can use two user terminals (as well as a built-in terminal) with addresses 31 and 32. The default user terminal address is 32, so only if a second terminal is required must the address of this be set to 31, as described below. The address of the terminal is also required when having to set the address of the pRack PR100 boards, when multiple boards are connected to the pLAN.

After having correctly connected and configured the pLAN network of pRack PR100 boards, the system can be configured as described in paragraph 4.1.

A.2.1 Setting the address of the terminal

The pRack PR100 user terminal is supplied with the default address 32, allowing the terminal to be used without requiring any additional operations; nonetheless, in order to use an additional terminal or configure the pLAN address of the boards, it needs to be changed according to the following procedure:

1. power the terminal via the special telephone connector;
2. press the 3 buttons, **↑**, **↓** and **←** together for at least 5 seconds; the terminal will display a screen similar to the one below, with the cursor flashing in the top left corner:

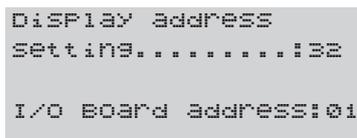

Fig. A.k

3. press **←** once: the cursor will move to the "Display address setting" field;
4. select the desired value using **↑** and **↓**, and confirm by pressing **←** again; if the value selected is different from the value saved, the following screen will be displayed and the new value will be saved to the display's permanent memory.

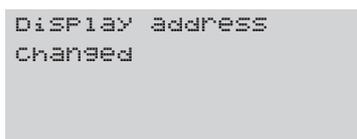

Fig. A.l

Note: if the address field is set to 0, the "I/O Board address" field is no longer displayed, as it has no meaning..

Important

- if the settings are not made correctly, the text and the images on the display will be displayed incorrectly and out of order.
- if during this operation the terminal detects inactivity of the pRack board whose output is being displayed, the display is cleared and a message similar to the one below is shown.

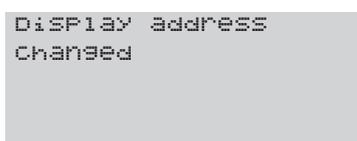

Fig. A.m

If the terminal detects inactivity of the entire pLAN network, that is, it does not receive any messages from the network for 10 seconds consecutively, it clears the display and shows the following link message:



Fig. A.n

A.2.2 Setting the address of the pRack PR100 board

The pLAN address of the pRack boards can be set from any pGD1 terminal, using the following procedure:

1. set address 0 on the terminal (see the previous paragraph for details on how to set this address);
2. power down the pRack PR100 board;
3. disconnect any pLAN connection to other boards from the pRack PR100 board;
4. connect the terminal to the pRack PR100 board;
5. power up the pRack PR100 board, while pressing the **↑** and **↵** buttons on the terminal together. After a few seconds the pRack PR100 board begins the start-up sequence and the display shows a screen similar to the one below:

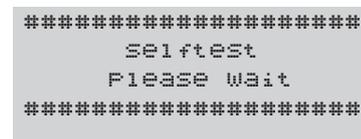

Fig. A.o

6. when this screen is displayed, wait 10 seconds and then release the buttons;
7. the pRack PR100 board interrupts the start-up sequence and shows a configuration screen, similar to the one below:

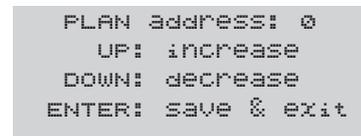

Fig. A.p

8. Confirm the address by pressing **←**: the pRack PR100 board completes the start-up sequence and uses the set address.

A3 Example of configuring a system with 2 suction and condenser lines using the Wizard

Below is a possible example of using the Wizard to configure a typical system like the one shown in the figure, with 2 suction lines and 2 condenser lines on different boards:

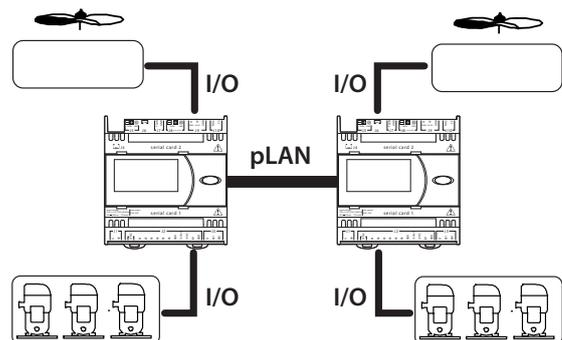

Fig. A.q

The preliminary operations to be completed before configuration are as follows:

1. with the boards not connected in the pLAN, power up the second pRack board and set the pLAN address to 2 (for details see Appendix A.2)
2. power down and connect the two boards in the pLAN, plus any terminals, as described in paragraph 3.7
3. power up the boards and wait for the Wizard selection screen to be displayed

Then select the type of system as SUCTION & CONDENSER:

```

Wizard Ib01
-----
TYPE OF INSTALLATION:
SUCTION & CONDENSER
    
```

Fig. A.r

Set the type of compressors and control for suction line 1, answering the questions prompted by the pRack PR100 software, e.g.:

```

Wizard Ib03
-----
COMPRESSOR CONFIG.
COMPRESSOR TYPE:
    RECIPROCATING
COMPRESSOR NUMBER: 3
    
```

Fig. A.s

```

Wizard Ib40
-----
COMPRESSOR CONFIG.
REGULATION BY:
    PRESSURE
MEASURE UNIT:  bar
REFRIGERANT:  R404A
    
```

Fig. A.t

```

Wizard Ib41
-----
COMPRESSOR CONFIG.
REGULATION TYPE:
    PROPORTIONAL BAND
Enable integral time
action:  YES
    
```

Fig. A.u

After having configured suction line 1, a prompt will be shown to configure another suction line, obviously the answer is YES:

```

Wizard Ib43
-----
COMPRESSOR CONFIG.
Configure another
suction line:  YES
    
```

Fig. A.v

To the next question, which prompts if there is a pRack board dedicated to the second line, answer YES; in this way, the pRack PR100 software prepares to configure the board with address 2 in the pLAN:

```

Wizard Ib45
-----
COMPRESSOR CONFIG.
Dedicated PRACK
board for
suction line:  YES
    
```

Fig. A.w

After having answered the questions for the configuration of the second suction line, the software then asks if there is a pLAN board dedicated to condenser line 1. In the case shown in the example, answer NO.

```

Wizard Ib30
-----
COMPRESSOR CONFIG.
Dedicated PRACK
board for
condensing line:  NO
    
```

Fig. A.x

After having configured condenser line 1, the software asks if condenser line 2 is used; answer YES:

```

Wizard Ib36
-----
Configure another
condensing line:  YES
    
```

Fig. A.y

After having configured the second condenser line, the software offers the option to automatically configure the I/Os (choosing YES), as described in par. 4.1.4. If choosing NO, each individual I/O needs to be configured manually at the end of the wizard. In addition, the software asks the user whether or not to display a summary of the settings made:

```

Wizard Ib23
-----
Enable I/O config: YES
Visualize wizard
report?  NO
(PUSH [DOWN]
to continue)
    
```

Fig. A.z

If the settings are correct, the set values can be installed:

```

Wizard Ib33
-----
Boards necessary
  1  _ _ _
  |
  2  _ _ _
All boards present,
(ENTER) to continue
    
```

Fig. A.aa

After waiting a few seconds, the unit can be started.

```

Wizard
-----
SUCCESSFULLY COMPLETE
Press (ENTER) to
continue
    
```

Fig. A.ab

 **Note:** after having configured pRack PR100, the device needs to be switched off and on again to permanently save the new data.

A.4 Alarm table

Code	Description	Reset	Delay	Alarm relay	Action
ALA01	Discharge temperature probe malfunction	Automatic	60s	R2	Related functions disabled
ALA02	Condensing pressure probe malfunction	Automatic	60s	R1	Related functions disabled
ALA03	Outside temperature probe malfunction	Automatic	60s	R2	Related functions disabled
ALA04	Generic probe malfunction A, PLB1	Automatic	60s	R2	Related functions disabled
ALA05	Generic probe malfunction B, PLB1	Automatic	60s	R2	Related functions disabled
ALA06	Generic probe malfunction C, PLB1	Automatic	60s	R2	Related functions disabled
ALA07	Generic probe malfunction D, PLB1	Automatic	60s	R2	Related functions disabled
ALA08	Generic probe malfunction E, PLB1	Automatic	60s	R2	Related functions disabled
ALA09	Generic probe malfunction A, PLB2	Automatic	60s	R2	Related functions disabled
ALA10	Generic probe malfunction B, PLB2	Automatic	60s	R2	Related functions disabled
ALA11	Generic probe malfunction C, PLB2	Automatic	60s	R2	Related functions disabled
ALA12	Generic probe malfunction D, PLB2	Automatic	60s	R2	Related functions disabled
ALA13	Generic probe malfunction E, PLB2	Automatic	60s	R2	Related functions disabled
ALA14	Generic probe malfunction A, PLB3	Automatic	60s	R2	Related functions disabled
ALA15	Generic probe malfunction B, PLB3	Automatic	60s	R2	Related functions disabled
ALA16	Generic probe malfunction C, PLB3	Automatic	60s	R2	Related functions disabled
ALA17	Generic probe malfunction D, PLB3	Automatic	60s	R2	Related functions disabled
ALA18	Generic probe malfunction E, PLB3	Automatic	60s	R2	Related functions disabled
ALA19	Generic probe malfunction A, PLB4	Automatic	60s	R2	Related functions disabled
ALA20	Generic probe malfunction B, PLB4	Automatic	60s	R2	Related functions disabled
ALA21	Generic probe malfunction C, PLB4	Automatic	60s	R2	Related functions disabled
ALA22	Generic probe malfunction D, PLB4	Automatic	60s	R2	Related functions disabled
ALA23	Generic probe malfunction E, PLB4	Automatic	60s	R2	Related functions disabled
ALA24	Suction pressure probe malfunction	Automatic	60s	R1	Related functions disabled
ALA25	Suction temperature probe malfunction	Automatic	60s	R2	Related functions disabled
ALA26	Room temperature probe malfunction	Automatic	60s	R2	Related functions disabled
ALA27	Condensing pressure probe malfunction, line 2	Automatic	60s	R1	Related functions disabled
ALA28	Discharge temperature probe malfunction, line 2	Automatic	60s	R2	Related functions disabled
ALA29	Suction pressure probe malfunction, line 2	Automatic	60s	R1	Related functions disabled
ALA30	Suction temperature probe malfunction, line 2	Automatic	60s	R2	Related functions disabled
ALA31	Condensing pressure backup probe malfunction	Automatic	60s	R2	Related functions disabled
ALA32	Condensing pressure backup probe malfunction, line 2	Automatic	60s	R2	Related functions disabled
ALA33	Suction pressure backup probe malfunction	Automatic	60s	R2	Related functions disabled
ALA34	Suction pressure backup probe malfunction, line 2	Automatic	60s	R2	Related functions disabled
ALA35	Common oil temperature probe malfunction	Automatic	60s	R2	Related functions disabled
ALA36	Common oil temperature probe malfunction, line 2	Automatic	60s	R2	Related functions disabled
ALA39	Discharge temperature probe malfunction, compressors 1 to 6	Automatic	60s	R2	Related functions disabled
ALA40	Discharge temperature probe malfunction, compressors 1 to 6, line 2	Automatic	60s	R2	Related functions disabled
ALA41	Oil temperature probe malfunction compressors 1 to 6, line 1	Automatic	60s	R2	Related functions disabled
ALA42	Oil temperature probe malfunction compressor 1, line 2	Automatic	60s	R2	Related functions disabled
ALB01	Low suction pressure from pressure switch	Semiautomatic	Settable	R1	Shutdown compressor
ALB02	High condensing pressure from pressure switch	Manual/automatic	Settable	R1	Shutdown compressor
ALB03	Low condensing pressure from probe	Automatic	Settable	R1	Force fans to 0%
ALB04	High condensing pressure from probe	Automatic	Settable	R1	Force fans to 100% and compressor stop
ALB05	Liquid level	Automatic	Settable	R2	-
ALB06	Common oil differential	Automatic	Settable	R2	-
ALB07	Common fan circuit breaker	Automatic	Settable	Settable	-
ALB08	Low suction pressure from pressure switch, line 2	Semiautomatic	Settable	R1	Shutdown compressors, line 2
ALB09	High condensing pressure from pressure switch, line 2	Manual/automatic	Settable	R1	Shutdown compressors, line 2
ALB10	Low condensing pressure from probe, line 2	Automatic	Settable	R1	Force fans to 0%, line 2
ALB11	High condensing pressure from probe, line 2	Automatic	Settable	R1	Force fans to 100% and stop compressor, line 2
ALB12	Liquid level, line 2	Automatic	Settable	R2	-
ALB13	Common oil differential, line 2	Automatic	Settable	R2	-
ALB14	Common fan circuit breaker, line 2	Automatic	Settable	Settable	-
ALB15	High suction pressure from probe	Automatic	Settable	R1	-
ALB16	Low suction pressure from probe	Automatic	Settable	R1	-
ALB17	High suction pressure from probe, line 2	Automatic	Settable	R1	-
ALB18	Low suction pressure from probe, line 2	Automatic	Settable	R1	-
ALB21	Shutdown to prevent high pressure	Manual	Settable	R1	Shutdown compressor
ALB22	Shutdown to prevent high pressure, line 2	Manual	Settable	R1	Shutdown compressors, line 2
ALC01	Alarm 1, compressor 1	Manual/automatic	Settable	Settable	Shutdown compressor 1
ALC02	Alarm 2, compressor 1	Manual/automatic	Settable	Settable	Shutdown compressor 1
ALC03	Alarm 3, compressor 1	Manual/automatic	Settable	Settable	Shutdown compressor 1
ALC04	Alarm 4, compressor 1	Manual/automatic	Settable	Settable	Shutdown compressor 1
ALC05	Alarm 5, compressor 1	Manual/automatic	Settable	Settable	Shutdown compressor 1
ALC06	Alarm 6, compressor 1	Manual/automatic	Settable	Settable	Shutdown compressor 1
ALC07	Alarm 7, compressor 1	Manual/automatic	Settable	Settable	Shutdown compressor 1
ALC08	Alarm 1, compressor 2	Manual/automatic	Settable	Settable	Shutdown compressor 2
ALC09	Alarm 2, compressor 2	Manual/automatic	Settable	Settable	Shutdown compressor 2
ALC10	Alarm 3, compressor 2	Manual/automatic	Settable	Settable	Shutdown compressor 2
ALC11	Alarm 4, compressor 2	Manual/automatic	Settable	Settable	Shutdown compressor 2
ALC12	Alarm 5, compressor 2	Manual/automatic	Settable	Settable	Shutdown compressor 2
ALC13	Alarm 6, compressor 2	Manual/automatic	Settable	Settable	Shutdown compressor 2
ALC14	Alarm 7, compressor 2	Manual/automatic	Settable	Settable	Shutdown compressor 2
ALC15	Alarm 1, compressor 3	Manual/automatic	Settable	Settable	Shutdown compressor 3
ALC16	Alarm 2, compressor 3	Manual/automatic	Settable	Settable	Shutdown compressor 3
ALC17	Alarm 3, compressor 3	Manual/automatic	Settable	Settable	Shutdown compressor 3
ALC18	Alarm 4, compressor 3	Manual/automatic	Settable	Settable	Shutdown compressor 3
ALC19	Alarm 5, compressor 3	Manual/automatic	Settable	Settable	Shutdown compressor 3
ALC20	Alarm 6, compressor 3	Manual/automatic	Settable	Settable	Shutdown compressor 3
ALC21	Alarm 7, compressor 3	Manual/automatic	Settable	Settable	Shutdown compressor 3
ALC22	Alarm 1, compressor 4	Manual/automatic	Settable	Settable	Shutdown compressor 4

Code	Description	Reset	Delay	Alarm relay	Action
ALCan	Compressor envelope	Manual	Settable	R1	Shutdown compressor
ALCao	High compressor oil temperature, line 1	Automatic	Settable	R2	-
ALCap	High compressor oil temperature, line 2	Automatic	Settable	R2	-
ALF01	Fan circuit breaker	Manual/automatic	Settable	R2	Shutdown fans
ALF02	Fan circuit breaker, line 2	Manual/automatic	Settable	R2	Shutdown fans
ALG01	Clock error	Automatic	-	R2	Related functions disabled
ALG02	Extended memory error	Automatic	-	R2	Related functions disabled
ALG11	Generic high temperature alarms 1 to 5, PLB1	Manual/automatic	Settable	Settable	-
ALG12	Generic high temperature alarms 1 to 5, PLB2	Manual/automatic	Settable	Settable	-
ALG13	Generic high temperature alarms 1 to 5, PLB3	Manual/automatic	Settable	Settable	-
ALG14	Generic high temperature alarms 1 to 5, PLB4	Manual/automatic	Settable	Settable	-
ALG15	Generic low temperature alarms 1 to 5, PLB1	Manual/automatic	Settable	Settable	-
ALG16	Generic low temperature alarms 1 to 5, PLB2	Manual/automatic	Settable	Settable	-
ALG17	Generic low temperature alarms 1 to 5, PLB3	Manual/automatic	Settable	Settable	-
ALG18	Generic low temperature alarms 1 to 5, PLB4	Manual/automatic	Settable	Settable	-
ALG19	Generic high modulation alarms 6 and 7, PLB1	Manual/automatic	Settable	Settable	-
ALG20	Generic high modulation alarms 6 and 7, PLB2	Manual/automatic	Settable	Settable	-
ALG21	Generic high modulation alarms 6 and 7, PLB3	Manual/automatic	Settable	Settable	-
ALG22	Generic high modulation alarms 6 and 7, PLB4	Manual/automatic	Settable	Settable	-
ALG23	Generic low modulation alarms 6 and 7, PLB1	Manual/automatic	Settable	Settable	-
ALG24	Generic low modulation alarms 6 and 7, PLB2	Manual/automatic	Settable	Settable	-
ALG25	Generic low modulation alarms 6 and 7, PLB3	Manual/automatic	Settable	Settable	-
ALG26	Generic low modulation alarms 6 and 7, PLB4	Manual/automatic	Settable	Settable	-
ALG27	Normal alarm generic functions 8/9, PLB1	Manual/automatic	Settable	Settable	-
ALG28	Serious alarm generic functions 8/9, PLB1	Manual/automatic	Settable	Settable	-
ALG29	Normal alarm generic functions 8/9, PLB2	Manual/automatic	Settable	Settable	-
ALG30	Serious alarm generic functions 8/9, PLB2	Manual/automatic	Settable	Settable	-
ALG31	Normal alarm generic functions 8/9, PLB3	Manual/automatic	Settable	Settable	-
ALG32	Serious alarm generic functions 8/9, PLB3	Manual/automatic	Settable	Settable	-
ALG33	Normal alarm generic functions 8/9, PLB4	Manual/automatic	Settable	Settable	-
ALG34	Serious alarm generic functions 8/9, PLB4	Manual/automatic	Settable	Settable	-
ALH01	ChillBooster fault	Automatic	Settable	R2	Disable ChillBooster
ALH02	ChillBooster fault, line 2	Automatic	Settable	R2	Disable ChillBooster
ALO02	pLAN malfunction	Automatic	60s	R1	Shutdown unit
ALT01	Compressor maintenance request	Manual	-	Not featured	-
ALT02	Compressor maintenance request, line 2	Manual	-	Not featured	-
ALT03	ChillBooster maintenance request	manual	0s	Not featured	-
ALT04	ChillBooster maintenance request, line 2	manual	0s	Not featured	-
ALU01	Configuration not allowed	Automatic	Not featured	Not featured	Shutdown unit
ALU02	Control probes missing	Automatic	Not featured	Not featured	Shutdown unit
ALW01	High pressure prevent warning	Automatic	Settable	Not featured	Shutdown compressor, except minimum load stage
ALW02	High pressure prevent warning, line 2	Automatic	Settable	Not featured	Shutdown compressor line 2, except minimum load stage
ALW03	Compressor inverter warning	Automatic	Not featured	Not featured	-
ALW04	Compressor inverter warning, line 2	Automatic	Not featured	Not featured	-
ALW05	Fan inverter warning	Automatic	Not featured	Not featured	-
ALW06	Fan inverter warning, line 2	Automatic	Not featured	Not featured	-
ALW07	Envelope warning: refrigerant not compatible with compressor series	Automatic	Not featured	Not featured	-
ALW08	Envelope warning: custom envelope not configured	Automatic	Not featured	Not featured	-
ALW09	Envelope warning: suction or condensing probes not configured	Automatic	Not featured	Not featured	-
ALW10	Low superheat warning	Automatic	Not featured	Not featured	-
ALW11	Low superheat warning, line 2	Automatic	Not featured	Not featured	-
ALW12	Warning, ChillBooster operating without outside sensor	Automatic	0s	Not featured	-
ALW13	Warning, ChillBooster operating without outside sensor, line 2	Automatic	0s	Not featured	-

Tab. A.b

A.5 I/O Table

Digital inputs

	Mask Index	Description	Chan.	Logic	Notes		
Line 1	Suction	Ac05, Baack			Unit ON/OFF line 1		
		Baa56, Caaah			Common low pressure switch line 1		
		Baada, Caa14			Compressor inverter warning		
		Baa02, Caa01			Alarm 1 compressor 1 line 1		
		Baa03, Caa02			Alarm 2 compressor 1 line 1		
		Baa04, Caa03			Alarm 3 compressor 1 line 1		
		Baa05, Caa04			Alarm 4 compressor 1 line 1		
		Baa06, Caa05			Alarm 5 compressor 1 line 1		
		Baa07, Caa06			Alarm 6 compressor 1 line 1		
		Baa08, Caa07			Alarm 7 compressor 1 line 1		
		Baa09, Caa15			Alarm 1 compressor 2 line 1		
		Baa10, Caa16			Alarm 2 compressor 2 line 1		
		Baa11, Caa17			Alarm 3 compressor 2 line 1		
		Baa12, Caa18			Alarm 4 compressor 2 line 1		
		Baa13, Caa19			Alarm 5 compressor 2 line 1		
		Baa14, Caa20			Alarm 6 compressor 2 line 1		
		Baa15, Caa21			Alarm 7 compressor 2 line 1		
		Baa17, Caa28			Alarm 1 compressor 3 line 1		
		Baa18, Caa29			Alarm 2 compressor 3 line 1		
		Baa19, Caa30			Alarm 3 compressor 3 line 1		
		Baa20, Caa31			Alarm 4 compressor 3 line 1		
		Baa21, Caa32			Alarm 5 compressor 3 line 1		
		Baa22, Caa33			Alarm 6 compressor 3 line 1		
		Baa23, Caa34			Alarm 7 compressor 3 line 1		
		Baa24, Caa40			Alarm 1 compressor 4 line 1		
		Baa25, Caa41			Alarm 2 compressor 4 line 1		
		Baa26, Caa42			Alarm 3 compressor 4 line 1		
		Baa27, Caa43			Alarm 4 compressor 4 line 1		
		Baa28, Caa44			Alarm 5 compressor 4 line 1		
		Baa29, Caa45			Alarm 6 compressor 4 line 1		
		Baa30, Caa46			Alarm 7 compressor 4 line 1		
		Baa32, Caa53			Alarm 1 compressor 5 line 1		
		Baa33, Caa54			Alarm 2 compressor 5 line 1		
		Baa34, Caa55			Alarm 3 compressor 5 line 1		
		Baa35, Caa56			Alarm 4 compressor 5 line 1		
		Baa36, Caa57			Alarm 5 compressor 5 line 1		
		Baa37, Caa58			Alarm 6 compressor 5 line 1		
		Baa38, Caa59			Alarm 7 compressor 5 line 1		
		Baa39, Caa65			Alarm 1 compressor 6 line 1		
		Baa40, Caa66			Alarm 2 compressor 6 line 1		
		Baa41, Caa67			Alarm 3 compressor 6 line 1		
		Baa42, Caa68			Alarm 4 compressor 6 line 1		
		Baa43, Caa69			Alarm 5 compressor 6 line 1		
		Baa44, Caa70			Alarm 6 compressor 6 line 1		
		Baa45, Caa71			Alarm 7 compressor 6 line 1		
		Baa47, Caa78			Alarm 1 compressor 7 line 1		
		Baa48, Caa79			Alarm 2 compressor 7 line 1		
		Baa49, Caa84			Alarm 1 compressor 8 line 1		
		Baa50, Caa85			Alarm 2 compressor 8 line 1		
		Baa51, Caa90			Alarm 1 compressor 9 line 1		
		Baa52, Caa91			Alarm 2 compressor 9 line 1		
		Baa53, Caa95			Alarm 1 compressor 10 line 1		
		Baa54, Caa99			Alarm 1 compressor 11 line 1		
		Baa55, Caaad			Alarm 1 compressor 12 line 1		
		Baa58, Caaaj			Common oil alarm line 1		
		Baa59, Caaak			Liquid level alarm line 1		
		Condenser	Baadc				Fan inverter warning line 1
			Baa57				Common high pressure switch line 1
			Baaau, Daa01				Fan overload 1 line 1
Baaav, Daa02					Fan overload 2 line 1		
Baaaw, Daa03					Fan overload 3 line 1		
Baaax, Daa04					Fan overload 4 line 1		
Baaay, Daa05					Fan overload 5 line 1		
Baaaz, Daa06					Fan overload 6 line 1		
Baaba, Daa07					Fan overload 7 line 1		
Baabb, Daa08					Fan overload 8 line 1		
Baabc, Daa09					Fan overload 9 line 1		
Baabd, Daa10					Fan overload 10 line 1		
Baabf, Daa11					Fan overload 11 line 1		
Baabf, Daa12					Fan overload 12 line 1		
Baabg, Daa13					Fan overload 13 line 1		
Baabh, Daa14					Fan overload 14 line 1		
Baabj, Daa15					Fan overload 15 line 1		
Baabj, Daa16					Fan overload 16 line 1		
Baabk, Daa17					Common fan overload line 1		
Other functions	Baabl					Heat recovery line 1	
	Baacx, Ega01				ChillBooster fault line 1		
	Baacz				Enable floating condensing line 1		
	Baacl, Caa00, Daa41				Set point compensation line 1		
	Daa43				Anti noise line 1		
	Daa44				Split condenser line 1		
Daa45				Enable floating condensing line 1			
Eaa02				Heat recovery activation line 1			

	Mask Index	Description	Chan.	Logic	Notes		
Line 2	Suction	Ac08, Baacy	Unit ON/OFF line 2				
		Baaap, Cbaah	Common low pressure switch line 2				
		Baadb, Cba14	Compressor inverter warning line 2				
		Baaar, Cbaaj	Common oil alarm line 2				
		Baa61, Cba01	Alarm 1 compressor 1 line 2				
		Baa62, Cba02	Alarm 2 compressor 1 line 2				
		Baa63, Cba03	Alarm 3 compressor 1 line 2				
		Baa64, Cba04	Alarm 4 compressor 1 line 2				
		Baa65, Cba05	Alarm 5 compressor 1 line 2				
		Baa66, Cba06	Alarm 6 compressor 1 line 2				
		Baa67, Cba07	Alarm 7 compressor 1 line 2				
		Baa68, Cba15	Alarm 1 compressor 2 line 2				
		Baa69, Cba16	Alarm 2 compressor 2 line 2				
		Baa70, Cba17	Alarm 3 compressor 2 line 2				
		Baa71, Cba18	Alarm 4 compressor 2 line 2				
		Baa72, Cba19	Alarm 5 compressor 2 line 2				
		Baa73, Cba20	Alarm 6 compressor 2 line 2				
		Baa74, Cba21	Alarm 7 compressor 2 line 2				
		Baa76, Cba28	Alarm 1 compressor 3 line 2				
		Baa77, Cba29	Alarm 2 compressor 3 line 2				
		Baa78, Cba30	Alarm 3 compressor 3 line 2				
		Baa79, Cba31	Alarm 4 compressor 3 line 2				
		Baa80, Cba32	Alarm 5 compressor 3 line 2				
		Baa81, Cba33	Alarm 6 compressor 3 line 2				
		Baa82, Cba34	Alarm 7 compressor 3 line 2				
		Baa83, Cba40	Alarm 1 compressor 4 line 2				
		Baa84, Cba41	Alarm 2 compressor 4 line 2				
		Baa85, Cba42	Alarm 3 compressor 4 line 2				
		Baa86, Cba43	Alarm 4 compressor 4 line 2				
		Baa87, Cba44	Alarm 5 compressor 4 line 2				
		Baa88, Cba45	Alarm 6 compressor 4 line 2				
		Baa89, Cba46	Alarm 7 compressor 4 line 2				
		Baa91, Cba53	Alarm 1 compressor 3 line 2				
		Baa92, Cba54	Alarm 2 compressor 3 line 2				
		Baa93, Cba55	Alarm 3 compressor 3 line 2				
		Baa94, Cba56	Alarm 4 compressor 3 line 2				
		Baa95, Cba57	Alarm 5 compressor 3 line 2				
		Baa96, Cba58	Alarm 6 compressor 3 line 2				
		Baa97, Cba59	Alarm 7 compressor 3 line 2				
		Baa98, Cba65	Alarm 1 compressor 4 line 2				
		Baa99, cba66	Alarm 2 compressor 4 line 2				
		Baaaa, Cba67	Alarm 3 compressor 4 line 2				
		Baaab, Cba68	Alarm 4 compressor 4 line 2				
		Baaac, Cba69	Alarm 5 compressor 4 line 2				
		Baaad, Cba70	Alarm 6 compressor 4 line 2				
		Baaae, Cba71	Alarm 7 compressor 4 line 2				
		Baaag, Cba78	Alarm 1 compressor 7 line 2				
		Baaah, Cba79	Alarm 2 compressor 7 line 2				
		Baaai, Cba84	Alarm 1 compressor 8 line 2				
		Baaaj, Cba85	Alarm 2 compressor 8 line 2				
		Baaak, Cba90	Alarm 1 compressor 9 line 2				
		Baaal, Cba91	Alarm 2 compressor 9 line 2				
		Baaam, Cba95	Alarm 1 compressor 10 line 2				
		Baaan, Cba99	Alarm 1 compressor 11 line 2				
		Baaao, Cbaad	Alarm 1 compressor 12 line 2				
		Baaas, Cbaak	Liquid level alarm line 2				
		Line 2	Condenser	Baadd	Fan inverter warning line 2		
				Baaaq	Common high pressure switch line 2		
				Baabn, Dba01	Fan overload 1 line 2		
Baabo, Dba02	Fan overload 2 line 2						
Baabp, Dba03	Fan overload 3 line 2						
Baabq, Dba04	Fan overload 4 line 2						
Baabr, Dba05	Fan overload 5 line 2						
Baabs, Dba06	Fan overload 6 line 2						
Baabt, Dba07	Fan overload 7 line 2						
Baabu, Dba08	Fan overload 8 line 2						
Baabv, Dba09	Fan overload 9 line 2						
Baabw, Dba10	Fan overload 10 line 2						
Baabx, Dba11	Fan overload 11 line 2						
Baaby, Dba12	Fan overload 12 line 2						
Babz, Dba13	Fan overload 13 line 2						
Baaca, Dba14	Fan overload 14 line 2						
Baacb, Dba15	Fan overload 15 line 2						
Baac, Dba16	Fan overload 16 line 2						
Baacd, Dba17	Common fan overload line 2						
Line 2	Other functions	Baace	Heat recovery line 2				
		Eqba01	ChillBooster fault line 2				
		Baade	Enable floating condensing line 2				
		Baacm, Cbd06, Dbd08	Set point compensation line 2				
		Dba43	Anti noise line 2				
		Dba44	Split condenser line 2				
Dba45	Enable floating condensing line 2						
Eeba02	Heat recovery activation line 2						
Comuni		Baacf, Efe16	Generic DI F				
		Baacg, Efe17	Generic DI G				
		Baach, Efe18	Generic DI H				
		Baac, Efe19	Generic DI I				
		Baacj, Efe20	Generic DI J				
		Baacn	pRack automatic or manual operation				
Baadf	pLoads digital input 1						
Baadg	pLoads digital input 2						

Digital outputs

	Mask Index	Description	Chan.	Logic	Notes	
Line 1	Suction	Bac02, Caa08				
			Line relay compressor 1 line 1			
			Partwinding/Star relay compressor 1 line 1			
			Delta relay compressor 1 line 1			
		Bac03, Caa09	Valve 1 compressor 1 line 1			
		Bac04, Caa10	Valve 2 compressor 1 line 1			
		Bac05, Caa11	Valve 3 compressor 1 line 1			
		Bac07, Caa12	Balancing valve compressor 1 line 1			
		Bac08, Caa22	Line relay compressor 2 line 1			
			Partwinding/Star relay compressor 2 line 1			
			Delta relay compressor 2 line 1			
		Bac10, Caa23	Valve 1 compressor 2 line 1			
		Bac11, Caa24	Valve 2 compressor 1 line 1			
		Bac12, Caa25	Valve 3 compressor 1 line 1			
		Bac13, Caa26	Balancing valve compressor 1 line 1			
		Bac15, Caa35	Line relay compressor 3 line 1			
			Partwinding/Star relay compressor 3 line 1			
			Delta relay compressor 3 line 1			
		Bac16, Caa36	Valve 1 compressor 3 line 1			
		Bac17, Caa37	Valve 2 compressor 3 line 1			
		Bac18, Caa38	Valve 3 compressor 3 line 1			
		Bac20, Caa39	Balancing valve compressor 3 line 1			
		Bac21, Caa47	Line relay compressor 4 line 1			
			Partwinding/Star relay compressor 4 line 1			
			Delta relay compressor 4 line 1			
		Bac22, Caa48	Valve 1 compressor 4 line 1			
		Bac23, Caa49	Valve 2 compressor 4 line 1			
		Bac24, Caa50	Valve 3 compressor 4 line 1			
		Bac26, Caa51	Balancing valve compressor 4 line 1			
		Bac28, Caa60	Line relay compressor 5 line 1			
			Partwinding/Star relay compressor 5 line 1			
			Delta relay compressor 5 line 1			
		Bac29, Caa61	Valve 1 compressor 5 line 1			
		Bac30, Caa62	Valve 2 compressor 5 line 1			
		Bac31, Caa63	Valve 3 compressor 5 line 1			
		Bac33, Caa64	Balancing valve compressor 5 line 1			
		Bac34, Caa72	Line relay, compressor 6 line 1			
			Partwinding/Star relay, compressor 6 line 1			
			Delta relay, compressor 6 line 1			
		Bac35, Caa73	Valve 1, compressor 6 line 1			
		Bac36, Caa74	Valve 2, compressor 6 line 1			
		Bac37, Caa75	Valve 3, compressor 6 line 1			
		Bac39, Caa76	Balancing valve, compressor 6 line 1			
		Bac41, Caa80	Line relay compressor 7 line 1			
			Partwinding/Star relay compressor 7 line 1			
			Delta relay compressor 7 line 1			
		Bac42, Caa81	Valve 1 compressor 7 line 1			
		Bac43, Caa82	Valve 2 compressor 7 line 1			
		Bac45, Caa83	Balancing valve compressor 7 line 1			
		Bac46, Caa86	Line relay compressor 8 line 1			
			Partwinding/Star relay compressor 8 line 1			
			Delta relay compressor 8 line 1			
		Bac47, Caa87	Valve 1 compressor 8 line 1			
		Bac48, Caa88	Valve 2 compressor 8 line 1			
		Bac50, Caa89	Balancing valve compressor 8 line 1			
		Bac51, Caa92	Line relay compressor 9 line 1			
			Partwinding/Star relay compressor 9 line 1			
			Delta relay compressor 9 line 1			
		Bac52, Caa93	Valve 1 compressor 9 line 1			
		Bac55, Caa94	Balancing valve compressor 9 line 1			
		Bac56, Caa96	Line relay compressor 10 line 1			
			Partwinding/Star relay compressor 10 line 1			
			Delta relay compressor 10 line 1			
		Bac57, Caa97	Valve 1 compressor 10 line 1			
		Bac60, Caa98	Balancing valve compressor 10 line 1			
		Bac61, Caaaa	Relay line compressor 11 line 1			
			Partwinding/Star relay compressor 11 line 1			
			Delta relay compressor 11 line 1			
		Bac62, Caaab	Valve 1 compressor 11 line 1			
		Bac65, Caaac	Balancing valve compressor 11 line 1			
Bac66, Caaae	Relay line compressor 12 line 1					
	Partwinding/Star relay compressor 12 line 1					
	Delta relay compressor 12 line 1					
Bac67, Caaaf	Valve 1 compressor 12 line 1					
Bac70, Caaag	Balancing valve compressor 12 line 1					
Ebaa01	Subcooling valve line 1					
Line 1	Condenser	Bacbt, Daa21	Fan 1 line 1			
		Bacbu, Daa22	Fan 2 line 1			
		Bacbv, Daa23	Fan 3 line 1			
		Bacbw, Daa24	Fan 4 line 1			
		Bacbx, Daa25	Fan 5 line 1			
		Bacby, Daa26	Fan 6 line 1			
		Bacbz, Daa27	Fan 7 line 1			
		Bacca, Daa28	Fan 8 line 1			
		Baccb, Daa29	Fan 9 line 1			
		Bacc, Daa30	Fan 10 line 1			
		Baccd, Daa31	Fan 11 line 1			
		Bacce, Daa32	Fan 12 line 1			
		Baccf, Daa33	Fan 13 line 1			
		Baccg, Daa34	Fan 14 line 1			
		Bacc, Daa35	Fan 15 line 1			
		Bacci, Daa36	Fan 16 line 1			

	Mask Index	Description	Chan.	Logic	Notes
Line 1	Other functions	Bacck, Eeaa03			Heat recovery pump line 1
		Baccl, Ega02			ChillBooster line 1
		Bacdp, Eaaa11			Oil pump 1 line 1
		Bacdq, Eaaa12			Oil pump 2 line 1
		Bacdr, Eaaa13			Oil fan line 1
		BacdV, Ecaa07, Edaa07			Liquid injection valve/Economizer compressor 1 line 1
		BacdW, Ecaa08, Edaa08			Liquid injection valve/Economizer compressor 2 line 1
		BacdX, Ecaa09, Edaa09			Liquid injection valve/Economizer compressor 3 line 1
		BacdY, Ecaa10, Edaa10			Liquid injection valve/Economizer compressor 4 line 1
		BacdZ, Ecaa11, Edaa11			Liquid injection valve/Economizer compressor 5 line 1
		Bacea, Ecaa12, Edaa12			Liquid injection valve/Economizer, compressor 6 line 1
		Bac01			Anti liquid return line 1
		Bacei			Force from BMS line 1
		Bacek, Ebaa01			Subcooling line 1
		Eaaa15			Oil cooling pump screw compressor 1 line 1
		Eaaa16			Oil cooling fan screw compressor 1 line 1
		Eaaa18			Oil cooling pump screw compressor 2 line 1
		Eaaa19			Oil cooling fan screw compressor 2 line 1
		Eaaa40			Oil level valve compressor 1 line 1
		Eaaa41			Oil level valve compressor 2 line 1
		Eaaa42			Oil level valve compressor 3 line 1
		Eaaa43			Oil level valve compressor 4 line 1
		Eaaa44			Oil level valve compressor 5 line 1
		Eaaa45			Oil level valve, compressor 6 line 1
		Line 2	Suction	Bac73, Cba08	
Bac74, Cba09					Valve 1 compressor 1 line 2
Bac75, Cba10					Valve 2 compressor 1 line 2
Bac76, Cba11					Valve 3 compressor 1 line 2
Bac78, Cba12					Balancing valve compressor 1 line 2
Bac79, Cba22					Line relay compressor 2 line 2 Partwinding/Star relay compressor 2 line 2 Delta relay compressor 2 line 2
Bac80, Cba23					Valve 1 compressor 2 line 2
Bac81, Cba24					Valve 2 compressor 1 line 2
Bac82, Cba25					Valve 3 compressor 1 line 2
Bac84, Cba26					Balancing valve compressor 1 line 2
Bac86, Cba35					Line relay compressor 3 line 2 Partwinding/Star relay compressor 3 line 2 Delta relay compressor 3 line 2
Bac87, Cba36					Valve 1 compressor 3 line 2
Bac88, Cba37					Valve 2 compressor 3 line 2
Bac89, Cba38					Valve 3 compressor 3 line 2
Bac91, Cba39					Balancing valve compressor 3 line 2
Bac92, Cba47					Line relay compressor 4 line 2 Partwinding/Star relay compressor 4 line 2 Delta relay compressor 4 line 2
Bac94, Cba48					Valve 1 compressor 4 line 2
Bac95, Cba49					Valve 2 compressor 4 line 2
Bac96, Cba50					Valve 3 compressor 4 line 2
Bac98, Cba51					Balancing valve compressor 4 line 2
Bacaa, Cba60					Line relay compressor 5 line 2 Partwinding/Star relay compressor 5 line 2 Delta relay compressor 5 line 2
Bacab, Cba61					Valve 1 compressor 5 line 2
Bacac, Cba62					Valve 2 compressor 5 line 2
Bacad, Cba63					Valve 3 compressor 5 line 2
Bacaf, Cba64					Balancing valve compressor 5 line 2

	Mask Index	Description	Chan.	Logic	Notes
Line 2	Suction	Bacag, Cba72	Line relay, compressor 6 line 2		
			Partwinding/Star relay, compressor 6 line 2		
			Delta relay, compressor 6 line 2		
		Bacah, Cba73	Valve 1 compressor 6 line 2		
		Bacai, Cba74	Valve 2 compressor 6 line 2		
		Bacaj, Cba75	Valve 3 compressor 6 line 2		
		Bacal, Cba76	Balancing valve, compressor 6 line 2		
		Bacan, Cba80	Line relay compressor 7 line 2		
			Partwinding/Star relay compressor 7 line 2		
			Delta relay compressor 7 line 2		
		Bacao, Cba81	Valve 1 compressor 7 line 2		
		Bacap, Cba82	Valve 2 compressor 7 line 2		
		Bacar, Cba83	Balancing valve compressor 7 line 2		
		Bacas, Cba86	Line relay compressor 8 line 2		
			Partwinding/Star relay compressor 8 line 2		
			Delta relay compressor 8 line 2		
		Bacat, Cba87	Valve 1 compressor 8 line 2		
		Bacau, Cba88	Valve 2 compressor 8 line 2		
		Bacaw, Cba89	Balancing valve compressor 8 line 2		
		Bacax, Cba92	Line relay compressor 9 line 2		
		Partwinding/Star relay compressor 9 line 2			
		Delta relay compressor 9 line 2			
	Bacay, Cba93	Valve 1 compressor 9 line 2			
	Bacbb, Cba94	Balancing valve compressor 9 line 2			
	Bacbc, Cba96	Line relay compressor 10 line 2			
		Partwinding/Star relay compressor 10 line 2			
		Delta relay compressor 10 line 2			
	Bacbd, Cba97	Valve 1 compressor 10 line 2			
	Bacbg, Cba98	Balancing valve compressor 10 line 2			
	Bacbh, Cbaaa	Line relay compressor 11 line 2			
		Partwinding/Star relay compressor 11 line 2			
		Delta relay compressor 11 line 2			
	Bacbj, Cbaab	Valve 1 compressor 11 line 2			
	Bacbl, Cbaac	Balancing valve compressor 11 line 2			
	Bacbm, Cbaae	Line relay compressor 12 line 2			
		Partwinding/Star relay compressor 12 line 2			
		Delta relay compressor 12 line 2			
	Bacbn, Cbaaf	Valve 1 compressor 12 line 2			
	Bacbg, Cbaag	Balancing valve compressor 12 line 2			
	Condenser	Baccn, Dba20	Fan1 line 2		
Bacco, Dba21		Fan 2 line 2			
Baccp, Dba22		Fan 3 line 2			
Baccq, Dba23		Fan 4 line 2			
Baccr, Dba24		Fan 5 line 2			
Baccs, Dba25		Fan 6 line 2			
Bacct, Dba26		Fan 7 line 2			
Baccu, Dba27		Fan 8 line 2			
Baccv, Dba28		Fan 9 line 2			
Baccw, Dba29		Fan 10 line 2			
Baccx, Dba30		Fan 11 line 2			
Baccy, Dba31		Fan 12 line 2			
Baccz, Dba32		Fan 13 line 2			
Bacda, Dba33		Fan 14 line 2			
Bacdb, Dba34		Fan 15 line 2			
Bacdc, Dba35		Fan 16 line 2			
Bacdd, Dba36		Fan inverter line 2			
Other functions		Bacde, Eeba03	Heat recovery pump line 2		
		Bacdf, Egba02	ChillBooster line 2		
		Bacds, Eaba10	Oil pump 1 line 2		
	Bacdt, Eaba11	Oil pump 2 line 2			
	Bacdu, Eaba12	Oil fan line 2			
	Baceb, Ecba07, Edba07	Liquid injection valve compressor 1 line 2			
	Bacec, Ebca08, Edba08	Liquid injection valve compressor 2 line 2			
	Baced, Ecba09, Edba09	Liquid injection valve compressor 3 line 2			
	Bacee, Ecba10, Edba10	Liquid injection valve compressor 4 line 2			
	Bacef, Ecba11, Edba11	Liquid injection valve compressor 5 line 2			
	Baceg, Ecba12, Edba12	Liquid injection valve compressor 6 line 2			
	Bac72	Anti liquid return line 2			
	Bacej	Force from BMS line 2			
	Bacel, Ebbb01	Subcooling line 2			
	Eaba40	Oil level valve compressor 1 line 2			
	Eaba41	Oil level valve compressor 2 line 2			
	Eaba42	Oil level valve compressor 3 line 2			
	Eaba43	Oil level valve compressor 4 line 2			
	Eaba44	Oil level valve compressor 5 line 2			
	Eaba45	Oil level valve, compressor 6 line 2			
Common	Bacdg, Efe21	Generic stage function 1			
	Bacdh, Efe22	Generic stage function 2			
	Bacdi, Efe23	Generic stage function 3			
	Bacdj, Efe24	Generic stage function 4			
	Bacdk, Efe25	Generic stage function 5			
	Bacdl	Active alarms			
	Bacdm, Efe26	Generic alarm function 1			
	Bacdn, Efe27	Generic alarm function 2			
	Bacdo, Efe28	Generic scheduling function			
	Baceh	Sign of life			
Bacem	Minor alarm				
Bacen	Serious alarm				

Tab. A.d

Analogue inputs

	Mask Index	Description	Chan.	Logic	Notes		
Line 1	Suct.	Bab01, Caaal					
		Bab02, Caaam	Return backup pressure probe line 1				
		Bab03, Caaao	Return temperature probe line 1				
	C	Bab04, Daa39	Condensing pressure probe line 1				
		Bab09, Daa40	Backup condensing pressure probe line 1				
	Other functions	Bab11, Daa41	Discharge temperature probe line 1				
		Bab12	Liquid temperature probe line 1				
		Bab13, Eaaa05	Heat recovery outlet temperature probe line 1				
		Bab15, Daa20	Outside temperature probe line 1				
		Bab16	Room temperature probe line 1				
		Bab17, Eaaa04	Oil temperature probe line 1				
		Bab29, Ecaa01, Edaa01	Discharge temperature probe compressor 1 line 1				
		Bab30, Ecaa02, Edaa02	Discharge temperature probe compressor 2 line 1				
		Bab31, Ecaa03, Edaa03	Discharge temperature probe compressor 3 line 1				
		Bab32, Ecaa04, Edaa04	Discharge temperature probe compressor 4 line 1				
		Bab33, Ecaa05, Edaa05	Discharge temperature probe compressor 5 line 1				
		Bab34, Ecaa06, Edaa06	Discharge temperature probe, compressor 6 line 1				
		Bab41, Eaaa05	Oil temperature probe compressor 1 line 1				
		Bab42, Eaaa06	Oil temperature probe compressor 2 line 1				
		Bab43, Eaaa07	Oil temperature probe compressor 3 line 1				
		Bab44, Eaaa08	Oil temperature probe compressor 4 line 1				
		Bab45, Eaaa09	Oil temperature probe compressor 5 line 1				
		Bab46, Eaaa10	Oil temperature probe compressor 6 line 1				
		Line 2	Suct.	Bab05, Caal	Return pressure probe line 2		
				Bab06, Caaam	Return backup pressure probe line 2		
	Bab07, Caaao			Return temperature probe line 2			
	C		Bab08, Dba39	Condensing pressure probe line 2			
			Bab10, Dba40	Backup condensing pressure probe line 2			
	Other		Bab48, Dba38	Discharge temperature probe line 2			
			Bab49	Liquid temperature probe line 2			
			Bab14, Eeba05	Heat recovery outlet temperature probe line 2			
			Bab18, Eaba04	Oil temperature probe line 2			
			Bab35, Ecba01, Edba01	Discharge temperature probe compressor 1 line 2			
Bab36, Ecba02, Edba02			Discharge temperature probe compressor 2 line 2				
Bab37, Ecba03, Edba03			Discharge temperature probe compressor 3 line 2				
Bab38, Ecba04, Edba04			Discharge temperature probe compressor 4 line 2				
Bab39, Ecba05, Edba05			Discharge temperature probe compressor 5 line 2				
Bab40, Ecba06, Edba06			Discharge temperature probe, compressor 6 line 2				
Bab47, Eaba05			Oil temperature probe compressor 1 line 2				
Common			Bab19, Efe06	Generic active probe A			
			Bab20, Efe07	Generic passive probe A			
			Bab21, Efe08	Generic active probe B			
			Bab22, Efe09	Generic passive probe B			
			Bab23, Efe10	Generic active probe C			
			Bab24, Efe11	Generic passive probe C			
	Bab25, Efe12		Generic active probe D				
	Bab26, Efe13		Generic passive probe D				
	Bab27, Efe14		Generic active probe E				
	Bab28, Efe15		Generic passive probe E				
Bab58	Energy meter						

Tab. A.e

Analogue outputs

	Mask Index	Description	Chan.	Logic	Notes
Line 1	Bad01, Caa14	Compressor inverter output line 1			
	Bad02, Eaaa14	Oil pump output line 1			
	Bad07, Daa38	Fan inverter output line 1			
	Bad08, Eaaa04	Heat recovery valve output line 1			
	Bad12, Efe29	Generic modulating output 1			
	Eaaa17	Oil cooling pump output screw compressor 1			
	Line 2	Bad04	Compressor inverter output line 2		
Bad05, Eaba13		Oil pump output line 2			
Bad10, Dba37		Fan inverter output line 2			
Bad11, Eeba04		Heat recovery valve output line 2			
Bad13, Efe30		Generic modulating output 2			
Eaaa20	Oil cooling pump output screw compressor 2				

Tab. A.f

CAREL

CAREL INDUSTRIES - Headquarters
Via dell'Industria, 11 - 35020 Brugine - Padova (Italy)
Tel. (+39) 049.9716611 - Fax (+39) 049.9716600
e-mail: carel@carel.com - www.carel.com

Agenzia / Agency: