

Heos

High efficiency showcase controller

CAREL



ENG User manual

**LEGGI E CONSERVA
QUESTE ISTRUZIONI**
→ **READ AND SAVE
THESE INSTRUCTIONS** ←

  **NO POWER
& SIGNAL
CABLES
TOGETHER**
READ CAREFULLY IN THE TEXT!

Integrated Control Solutions & Energy Savings

WARNINGS



CAREL bases the development of its products on decades of experience in HVAC, on the continuous investments in technological innovations to products, procedures and strict quality processes with in-circuit and functional testing on 100% of its products, and on the most innovative production technology available on the market. CAREL and its subsidiaries nonetheless cannot guarantee that all the aspects of the product and the software included with the product respond to the requirements of the final application, despite the product being developed according to start-of-the-art techniques. The customer (manufacturer, developer or installer of the final equipment) accepts all liability and risk relating to the configuration of the product in order to reach the expected results in relation to the specific final installation and/or equipment. CAREL may, based on specific agreements, act as a consultant for the positive commissioning of the final unit/application, however in no case does it accept liability for the correct operation of the final equipment/system.

The CAREL product is a state-of-the-art product, whose operation is specified in the technical documentation supplied with the product or can be downloaded, even prior to purchase, from the website www.carel.com. Each CAREL product, in relation to its advanced level of technology, requires setup/configuration/programming/commissioning to be able to operate in the best possible way for the specific application. The failure to complete such operations, which are required/indicated in the user manual, may cause the final product to malfunction; CAREL accepts no liability in such cases. Only qualified personnel may install or carry out technical service on the product. The customer must only use the product in the manner described in the documentation relating to the product.

In addition to observing any further warnings described in this manual, the following warnings must be heeded for all CAREL products:

- prevent the electronic circuits from getting wet. Rain, humidity and all types of liquids or condensate contain corrosive minerals that may damage the electronic circuits. In any case, the product should be used or stored in environments that comply with the temperature and humidity limits specified in the manual.
- do not install the device in particularly hot environments. Too high temperatures may reduce the life of electronic devices, damage them and deform or melt the plastic parts. In any case, the product should be used or stored in environments that comply with the temperature and humidity limits specified in the manual.
- do not attempt to open the device in any way other than described in the manual.
- do not drop, hit or shake the device, as the internal circuits and mechanisms may be irreparably damaged.
- do not use corrosive chemicals, solvents or aggressive detergents to clean the device.
- do not use the product for applications other than those specified in the technical manual.

All of the above suggestions likewise apply to the controllers, serial boards, programming keys or any other accessory in the CAREL product portfolio.

CAREL adopts a policy of continual development. Consequently, CAREL reserves the right to make changes and improvements to any product described in this document without prior warning.

The technical specifications shown in the manual may be changed without prior warning.

The liability of CAREL in relation to its products is specified in the CAREL general contract conditions, available on the website www.carel.com and/or by specific agreements with customers; specifically, to the extent where allowed by applicable legislation, in no case will CAREL, its employees or subsidiaries be liable for any lost earnings or sales, losses of data and information, costs of replacement goods or services, damage to things or people, downtime or any direct, indirect, incidental, actual, punitive, exemplary, special or consequential damage of any kind whatsoever, whether contractual, extra-contractual or due to negligence, or any other liabilities deriving from the installation, use or impossibility to use the product, even if CAREL or its subsidiaries are warned of the possibility of such damage.

IMPORTANT



Separate as much as possible the probe and digital input cables from the cables carrying inductive loads and power cables to avoid possible electromagnetic disturbance.

Never run power cables (including the electrical panel cables) and signal cables in the same conduits.

DISPOSAL



INFORMATION FOR USERS ON THE CORRECT HANDLING OF WASTE ELECTRICAL AND ELECTRONIC EQUIPMENT (WEEE)

In reference to European Union directive 2002/96/EC issued on 27 January 2003 and the related national legislation, please note that:

- WEEE cannot be disposed of as municipal waste and such waste must be collected and disposed of separately;
- the public or private waste collection systems defined by local legislation must be used. In addition, the equipment can be returned to the distributor at the end of its working life when buying new equipment;
- the equipment may contain hazardous substances: the improper use or incorrect disposal of such may have negative effects on human health and on the environment;
- the symbol (crossed-out wheeled bin) shown on the product or on the packaging and on the instruction sheet indicates that the equipment has been introduced onto the market after 13 August 2005 and that it must be disposed of separately;
- in the event of illegal disposal of electrical and electronic waste, the penalties are specified by local waste disposal legislation.

Warranty on materials: 2 years (from the date of production, excluding the consumable parts).

Certification: the quality and safety of CAREL S.p.A. products are guaranteed by the ISO 9001 certified design and production system.

Content

1. INTRODUCTION	7	9. SOFTWARE UPDATE	50
1.1 Main features	7	9.1 Setting the controller's address.....	50
1.2 Components and accessories	7	9.2 Setting the terminal's address and connecting the controller to the terminal	50
2. INSTALLATION	8	9.3 Uploading/updating the software	51
2.1 Main board: connector's description	8	9.4 pCO Manager: operating instructions	52
2.2 Inverter monofase 10A	9	9.5 History of software revisions	54
2.3 12-16 A single-phase inverter	10		
2.4 E ² V unipolar valve	11		
2.5 Pressure probe (SPKT00**R0).....	11		
2.6 Temperature probe.....	11		
2.7 General connection diagram.....	12		
2.8 Functional diagrams.....	13		
2.9 Installation	14		
3. USER INTERFACE	15		
3.1 pGDe and pLDPRO Keypad.....	15		
3.2 "Main" mask.....	15		
3.3 PLD terminal	15		
4. MENU DESCRIPTION	16		
4.1 Main menu	16		
5. START-UP	17		
5.1 Guided commissioning procedure	17		
6. FUNCTIONS	18		
6.1 Probes (analogue inputs).....	18		
6.2 Digital inputs	19		
6.3 Analogue outputs.....	20		
6.4 Digital outputs	20		
6.5 Control.....	20		
6.6 Compressor	22		
6.7 Defrost.....	25		
6.8 Evaporator fans.....	29		
6.9 Electronic valve.....	29		
6.10 Protection functions.....	30		
6.11 Anti-sweat heater or fan modulation.....	32		
6.12 Condenser control.....	33		
6.13 Anti-sweat on inverter with cold plate.....	34		
7. PARAMETER TABLE	35		
8. SIGNALS AND ALARMS	47		
8.1 Alarm management.....	47		
8.2 Compressor alarms	47		
8.3 EEV valve protector alarms.....	47		
8.4 Temperature alarms	47		
8.5 Alarm table	49		

1. INTRODUCTION

1.1 Main features

Heos is a control system for the complete management of showcases or cold rooms in which the compressor (variable speed or on/off) is cooled by a water loop.

The control board is ready for DIN rail assembly, is fitted with plug-in screw terminals and comes with a built-in electronic expansion valve driver.

In order to manage multiplexed showcases, Heos can manage a local Master-Slave network comprising a maximum of 6 units (1 Master and 5 Slave). Each controller can be fitted with its own display (PLD) and/or user terminal (pGDe), for service or commissioning.

Main features:

- board with built-in driver for CAREL single-pole valve;
- modulating management of cooling capacity by inverter on BLDC compressor;
- stand-alone or multi-evaporator management;
- automatic balancing of cooling capacity in multi-evaporator configuration;
- COP calculation and management;
- advanced superheat control with protection against low superheat (LowSH), low evaporation temperature (LOP), high evaporation temperature (MOP) and low suction temperature (LSA);
- defrosts can be activated from the keypad, digital input, via network from the Master, or supervisor;
- various types of defrost available: electric heater, reverse cycle, hot gas;
- smart defrost functions;
- coordination of network defrosts;
- management of lights and curtains;
- anti-sweat heater modulation;
- evaporator fan speed modulation;

- possibility to display and set Slave parameters from the Master;
- sharing of one or more network probes (e.g. network pressure probe);
- HACCP alarm management;
- RS485 serial for BMS inside.

1.2 Components and accessories

Part number	Description
UP2AH010302SK	Heos high efficiency showcase controller - 230 Vac power supply
UP2BH010302SK	Heos high efficiency showcase controller - 24V power supply
UP2AH030302SK	Heos for cabinets with cover - 230 Vac power supply
UP2BH030302SK	Heos for cabinets with cover - 24 V power supply
PGDEH00FZ0	pGDE Heos display, for panel mounting, with buzzer
PLDH0GF00	pLDpro Heos display, for panel mounting, with buzzer
S90CONN000	Connector for pGD evolution display, 1.5 m long
S90CONN001	Connector for pGD evolution display, 3 m long
PLDH0SF400	PLD small Heos, green display
PLDCON03B0	3 m cable for PLD display
PLDCON05B0	5 m cable for PLD display
PSD10102BA	POWER+ 10 A, 200-240 Vac 1PH, IP00 con COLDPLATE
PSD10122A0	POWER+ 12 A, 200-240 Vac 1PH, IP20/IP44 con COLDPLATE
PSD10162A0	POWER+ 16 A, 200-240 Vac 1PH, IP20/IP44 con COLDPLATE
PSD101021A	POWER+ 10 A, 200-240 Vac 1PH, IP00
PSD1012200	POWER+ 12 A, 200-240 Vac 1PH, IP20/IP44
PSD1016200	POWER+ 16 A, 200-240 Vac 1PH, IP20/IP44
E2V**USF10	EXP unpolar valve - E2V* 12-12 ODF, 2 m cable long
NTC030HP00	NTC temp. probe, HP IP67, -50T50, 3 m long
NTC030HF01	NTC temp. probe, HF IP67, -50T90, strap-on, lungh. 3m. 10 pz
NTC030HT41	NTC temp. probe, HT IP55, 0T150, lungh. 3 m, 10 pz
SPKT0043R1	Pressure probe, 0-5V 0...17,3 barg (0...250 psig), 50 pz
SPKT00B6R1	Pressure probe, 0-5V 0...45 barg (0...650 psig), 50 pz
SPKC002310	3-wire cable, 2 m long, for SPKT pressure probes, IP67 Packard connector

Tab. 1.a

Example of stand-alone system

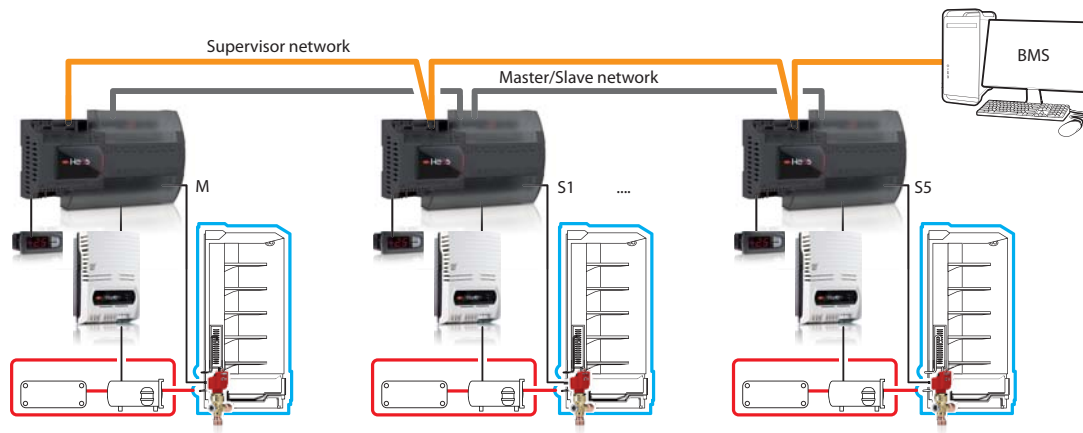

Fig. 1.a

Example of multi-evaporator system

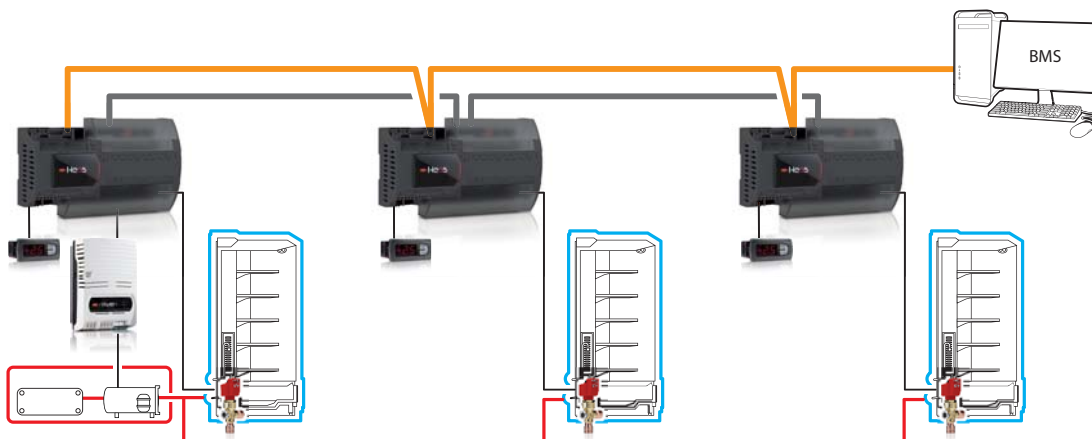

Fig. 1.b

2. INSTALLATION

2.1 Main board: connector's description

For further details on the electrical and mechanical specifications, see instruction sheet +050001590

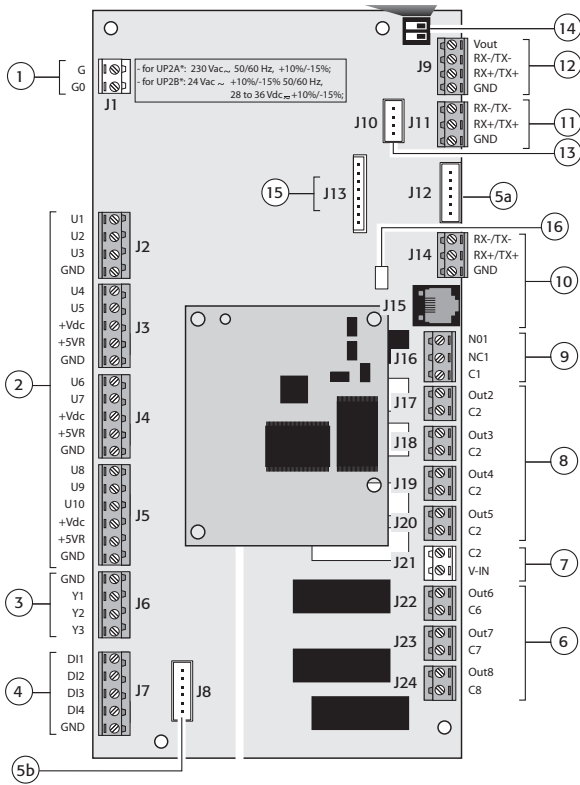

Fig. 2.a

Key:

1	Power supply 230Vac for version with transformer (UP2A*****)	
	Power supply 24Vac for version without transformer (UP2B*****)	
2	Universal channel	9 Alarm digital output
3	Analog outputs	10 Serial line pLAN
4	Digital inputs	11 Serial line BMS2
5a	Valve output 1	12 Serial line Fieldbus
5b	Valve output 2	13 PLD terminal connector
6	Relay digital output switch type	14 Dipswitch for selection
7	Voltage inputs for digital output 2, 3, 4, 5	15 Serial card RS485 BMS1
8	Voltage digital outputs	16 Power supply - Green Led

Digital inputs	Type: digital inputs with voltage-free contacts Number of digital inputs (DI): 4
Analogue outputs	Type: 0 to 10 Vdc cont., PWM 0 to 10 V 50 Hz synch. with power supply, PWM 0 to 10 V frequency 100 Hz, PWM 0 to 10 V frequency 2 kHz Number of analogue outputs (Y): 3
Universal channels	Analogue/digital conversion bits: 14 Type of input selectable from application: NTC, PT1000, PT500, PT100, 4 to 20 mA, 0 to 1 V, 0 to 5 V, 0 to 10 V, voltage-free contact digital input Type of output selectable from application: PWM 0/3.3 V 100 Hz synchronous with power supply PWM 0/3.3 V 100 Hz, PWM 0/3.3 V 2 kHz, 0 to 10 V analogue output Maximum current 2 mA Number of universal channels (U): 10 Precision of passive probe reading: ± 0.5 °C across entire temperature range; Precision of active probe reading: ± 0.3% across entire voltage range; Output precision: ± 2%
Digital outputs	Group 1, Switchable power R1: NO 1(1)A Group 2, Switchable power R3, R4, R5: NO NO 2(2)A Group 3, Switchable power R6, R7, R8: NO 6(6)A Maximum switchable voltage: 250 Vac Switchable power R2 (SSR case mounting): 15 VA 110/230 Vac The relays in the same group have basic insulation between each other and therefore must have the same power supply Relays belonging to different groups have reinforced insulation and consequently a different power supply can be used
Single-pole valve outputs	Maximum output for each valve: 7 W Type of control: single-pole Valve connector: 6-pin, fixed sequence Power supply: 12 Vdc ±5% Maximum current: 0.3 A for each winding Minimum winding resistance: 40 Ω Maximum cable length: 2 m

Tab. 2.a

Mechanical and Electrical specifications

Power supply:

230 Vac, +10...-15% UP2A*****;
24 Vac +10%/-15% 50/60 Hz,
28 to 36 Vdc +10...-15% UP2B*****;

Max power input: 25 VA

Insulation between power supply and instrument

- mod. 230Vac: reinforced

- mod. 24Vac: reinforced ensured by power supply of safety transformer

Max voltage connectors J1 and from J16 to J24: 250 Vac;
Minimum section of the wires - digital outputs: 1,5 mm²
Minimum section of wires of all others connectors: 0,5mm²

Power supplied

Type: +Vdc, +5VR, Vout for external power supply

+Vdc: 26 Vdc ±15% models 230Vac power supply (UP2A*****),

21 Vdc ±5% models 24 Vac power supply (UP2B*****)

Max current available +Vdc: 100mA, total taken from all connectors, protected against short-circuits

+5 VR: 5 Vdc ±2%; Max current available 100 mA, total taken from all connectors, protected against short-circuits

Vout: 26 Vdc ±15% for models 230 Vac power supply (UP2A*****),
21 Vdc ±5% Max current available (J9): 100 mA

Product specifications

Program memory: (FLASH): 4 MB

Log memory: 2 MB

Internal clock precision: 100 ppm

Removable battery: Lithium button, CR2430, 3 Vdc

Battery lifetime: minimum 8 years

User interface available

Type: all the pGD terminals with connector J15, PLD terminal with connector J10

Max distance for pGD terminal: 2m by telephone connector J15, 50m by shield-cable AWG24

Maximum number of user interface: One user interface pGD on the connector J15 or J14. One PLD user interface choosing tLAN protocol on the on board dip switch

Communication lines available

Type: RS485, Master for FieldBus1, Slave for BMS 2, pLAN

Number and type of available lines:

1 line not optoinsulated on J11 connector (BMS2).

1 line not optoinsulated on J9 connector (FieldBus), if not used from PLD user interface on J10 connector.

1 line not optoinsulated on J14 connector (pLAN), if not used from pGD user interface on J115 connector.

1 optional line (J13), selectable from Carel optionals

Maximum connection cable-length: 2m without shield-cable, 500m by shield-cable AWG24

Maximum connections lenght

Universal digital inputs and everything without different specification: less than 10m

Digital outputs: less than 30m

Serial Lines: check indication on relevant section

Operating conditions

Storage: -40T70 °C, 90% rH non-condensing

Operating: -40T70 °C, 90% rH non-condensing

Mechanical specifications

Dimensions: 13 DIN rail modules, 228 x 113 x 55 mm

Ball pressure test: 125 °C

Other specifications

Environmental pollution: 2 level

Index of protection: IP00

Class according to protection against electric shock: to be incorporated into Class I and/or II appliances

PTI of the insulating materials PCB: PTI250; insulation material: PTI 175

Period of stress across the insulating parts: long

Type of action: 1C; 1Y for SSR versions

Type of disconnection or microswitching: microswitching

category of resistance to heat and fire: category D (UL94 - V2)

Immunity against voltage surges: category II

software class and structure: Class A

To not touch or maintenance the product when power supply is applied

2.2 Inverter monofase 10A

For further details on the electrical and mechanical specifications, see instruction sheet +05000761E

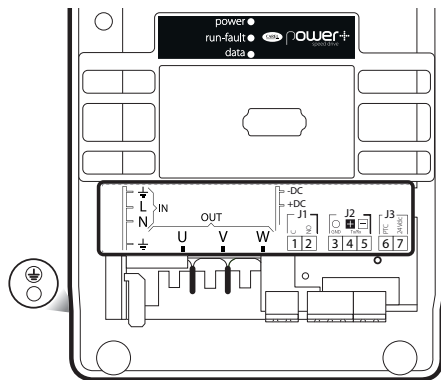

Fig. 2.b

Description of the terminals:

Ref.	Description	
L, N	Single-phase power supply input	
⊥ earth (*)		
U, V, W	Motor output	
⊥ earth (*)		
-DC	DC bus output	
+DC	DC bus output	
J1-1	C	DC bus output
J1-2	NO	
J2-3	0V	RS485/ModBus® connection
J2-4	Tx/Rx+	
J2-5	Tx/Rx-	
J3-6	PTC	PTC input (black connector)
J3-7	24 Vdc	
E	PE ⊕	
F (Led)	POWER (green)	drive powered
	RUN/FAULT (green/red)	drive running / drive alarm
	DATA (yellow)	communication active

Tab. 2.b

(*) The earth connections inside the drive are electrically connected together and to PE.

Important: before carrying out any maintenance work, disconnect the drive and the external control circuits from the power supply by moving the main system switch to "off". Once power has been disconnected from the drive, wait at least 5 minutes before disconnecting the electrical cables.

Coldplate with cooling adapter

The Coldplate with cooling adapter version (PSD10102BA) is provided with four threaded holes M5 on the aluminum plate for fixing.

Assembly

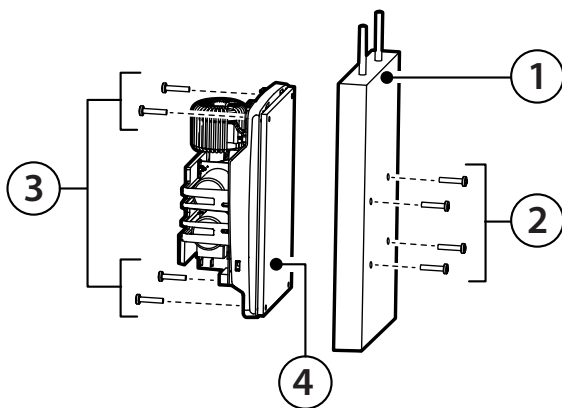

Key:

1	Coldplate cooling device (example)
2	Holes/screws for fastening the coldplate from rear of drive (4 x M5 holes, max. 14mm deep)
3	Holes/screws for fastening the coldplate from front of drive
4	Power+ plate
Note: the air-cooled heat sink is shown in grey in the dimensioned drawing.	

Technical specifications

Operating temperature	-20T60°C
Humidity	<95% U.R. non-condensing
Pollution degree	Max 2
Input voltage	200 - 240V ± 10%, 50 - 60Hz, 1~
Output voltage	0 - Input voltage
Output frequency	0 - 500 Hz
Maximum length	5 m
Switching frequency	4, 6, 8 kHz
Protection functions	Drive: short-circuit, overcurrent, ground fault, overvoltage and undervoltage, overtemperature Motor: overtemperature and overload (150% rated current for 1 minute) System: short-circuit
Frequency resolution	0,1 Hz
Inputs	1 motor protector input: PTC temp. probe or voltage-free contact max source current 10 mA, max. length 25 m
Outputs	1 relay: Programmable output, voltage-free contact: 240 Vac, 1 A
Serial data connection	RS485, Modbus® protocol, max. transmission speed 19200 bit/s.
24Vdc auxiliary power supply	Double insulation, precision 10%, 50mA max
Maximum length	100m shielded cable
Index of protection	IP00

Tab. 2.c

CE conformity:

2006/95/EC

EN 61800-5-1: Adjustable speed electrical power drive systems. Safety requirements. Electrical, thermal and energy.

2004/108/EC

EN 61800-3, ed.2.0.: Adjustable speed electrical power drive systems. EMC requirements and specific test methods.

EN61000-3-2: Electromagnetic compatibility (EMC) Part 3-2: Limits for harmonic currents (equipment connected with input current > 16 A per phase).

EN61000-3-12: Electromagnetic compatibility (EMC) Part 3-12: Limits - Limits for harmonic currents (equipment connected with input current > 16 A and <= 75 A per phase).

Rated values

The table below shows the rated input and output values, as well as the specifications for sizing the cables (cross-section, maximum length) and the fuses. The values refer to an operating temperature of 60 °C and a switching frequency of 8 kHz, unless otherwise specified.

PSD10102BA	
Rated input current at 230V	17 A
Fuse or type B circuit breaker	25 A
Power cable cross-section	4 mm ²
Rated output current	10 A
Rated output power at 230V	3,8 kW
Max. total dissipation	270 W
Max. heatsink dissipation	150 W
Minimum motor cable cross-section	2,5 mm ²
Maximum motor cable length	5 m

Tab. 2.d

Dimensions

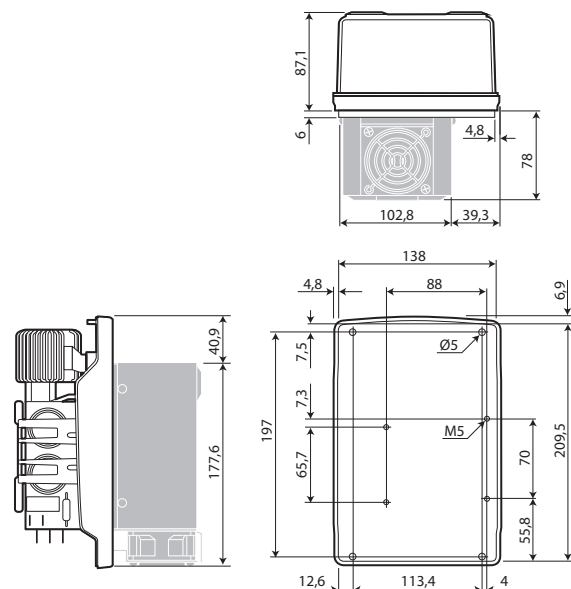

2.3 12-16 A single-phase inverter

For further details on the electrical and mechanical specifications, see instruction sheet +05000481E

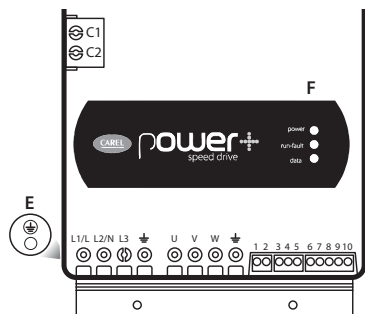

Fig. 2.c

Description of the terminals:

Ref.	Description
L1/L, L2/N, L3	Three-phase power supply input
⊥ earth (*)	
L1/L, L2/N	Single-phase power supply input
⊥ earth (*)	
U, V, W	Motor output
⊥ earth (*)	
C1, C2	Terminal block not used in PSD10**2**. For optional external DC Choke in PSD10184** e PSD10244**
1,2	Relay output
3	0V
4	Tx/Rx+
5	Tx/Rx-
6	PTC input
7	24 Vdc
8	0V
9	STOa
10	STOb
E	PE ⊕
F (Led)	POWER (green) drive powered RUN/FAULT (green/red) drive running / drive alarm DATA (yellow) communication active

Tab. 2.e

(*) The earth connections inside the drive are electrically connected together and to PE.
(**) To enable the drive for operation, apply a voltage of 24 Vac/Vdc to the Safe Torque Off digital input. The polarity is indifferent for direct current power supply.

Coldplate with cooling adapter

The Power+ Coldplate (PSD10***A0) models are the same as respective standard Power+ models, with the unique difference that the finned heatsink and fan are replaced by a flat aluminium plate. The plate has threaded holes M5 for fixing an additional device with cooling function (coldplate), typically using liquid refrigerant. The coldplate is the user's responsibility and is not supplied by Carel.

Assembly

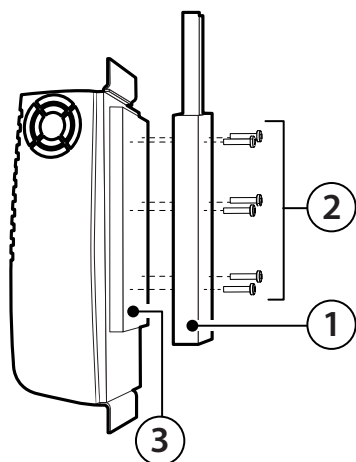

Key:

1	Coldplate cooling device (example)
2	Holes/screws for fastening the coldplate
3	Power+ plate

Note: the air-cooled heat sink is shown in grey in the dimensioned drawing.

Technical specifications

Operating temperature	-20T60°C
Humidity	<95% U.R. non-condensing
Pollution degree	Max 2
Input voltage	200 - 240V ± 10%, 50 - 60Hz, 1~
Output voltage	0 - Input voltage
Output frequency	0 - 500 Hz
Maximum length	5 m
Switching frequency	4, 6, 8 kHz
Protection functions	Drive: short-circuit, overcurrent, ground fault, over-voltage and undervoltage, overtemperature Motor: overtemperature and overload (150% Inom for 1 minute) System: Safe Torque OFF input, loss of communication
Frequency resolution	0,1 Hz
Inputs	1 motor protector input: PTC temp. probe or voltage-free contact max source current 10mA, max. length 25 m
Outputs	1 relay: progr. output, voltage-free contact: 240Vac, 1A
Serial input	RS485, Modbus® protocol, max transmission speed 19200 bit/s
24 Vdc auxiliary power	Double insulation, precision 10%, 50mA max
Maximum length	100m shielded cable
Index of protection	IP20

Tab. 2.f

CE conformity:

2006/95/EC
EN 61800-5-1: Adjustable speed electrical power drive systems. Safety requirements. Electrical, thermal and energy.

2004/108/EC
EN 61800-3, ed.2.0: Adjustable speed electrical power drive systems. EMC requirements and specific test methods.
EN61000-3-2: Electromagnetic compatibility (EMC) Part 3-2: Limits for harmonic currents (equipment connected with input current > 16 A per phase).
EN61000-3-12: Electromagnetic compatibility (EMC) Part 3-12: Limits - Limits for harmonic currents (equipment connected with input current > 16 A and <= 75 A per phase).

Rated values

The table below shows the rated input and output values, as well as the specifications for sizing the cables (cross-section, maximum length) and the fuses. The values refer to an operating temperature of 60 °C and a switching frequency of 8 kHz, unless otherwise specified.

Models	PSD10122A0	PSD10162A0
Rated input current at 230V	22 A	28 A
Fuse or type B circuit breaker	32 A	40 A
Power cable cross-section	4 mm ²	6 mm ²
Rated output current	12 A	16A
Rated output power at 230V	4,5 kW	6 kW
Max. total dissipation	330 W	450 W
Max. heatsink dissipation	190 W	250 W
Minimum motor cable cross-section	2,5 mm ²	2,5 mm ²
Maximum motor cable length	5 m	5 m

Tab. 2.g

Dimensions

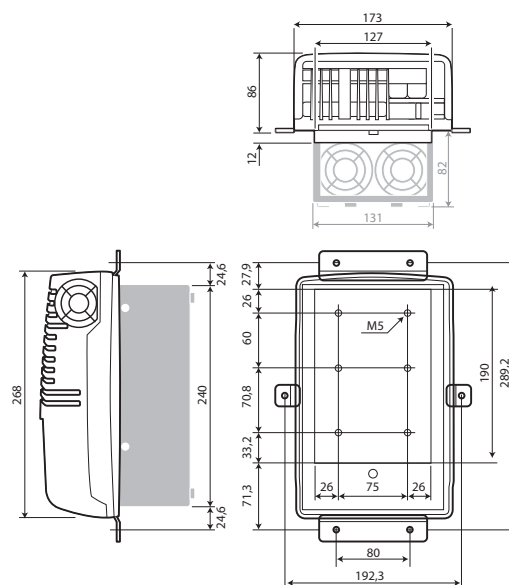

2.4 E²V unipolar valve

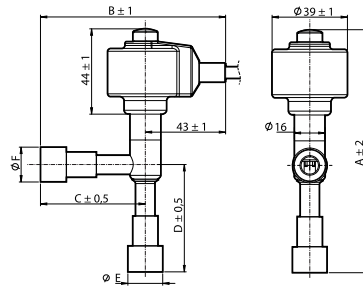
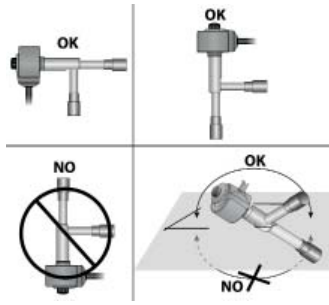

Valve type	E2V**USF** copper
A	123,7 mm (4,87 inch)
B	95,3 mm (3,28 inch)
C	52,2 mm (2,06 inch)
D	53,5 mm (2,11 inch)
E	Est. 14/Int. 12 mm (out 0,55/in 0,47 inch)
F	Est. 14/Int. 12 mm (out 0,55/in 0,47 inch)

Operating specification CAREL E²V-U

Reference technical document	+050001440
Compatibility	R22, R134a, R404A, R407C, R410A, R744, R507A, R417A
Maximum Operating Pressure (MOP)	up to 45 bar (653 psi)
Maximum Operating DP (MOPD)	35 bar (508 psi)
P.E.D.	Gr. 2, art. 3, par. 3
Refrigerant temperature	-40T65 °C (-40T149 °F)
Room temperature	-30T50 °C (-22T122 °F)

CAREL-Stator E²V-U

Reference technical document	+050001440
Power supply voltage	12 V
Drive frequency	50 Hz
Phase resistance (25 °C)	40 Ohm ± 10%
Index of protection	IP67
Connections	6 poles, cable length: 2 m
Complete closing steps	500 / 480

Tab. 2.h

2.5 Pressure probe (SPKT00**R0)

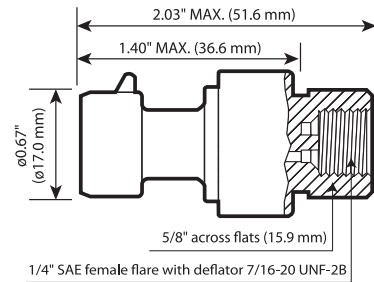
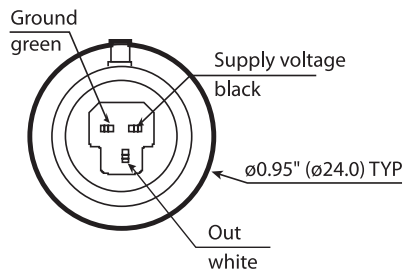

Reference technical document	+050000485
Power supply	4,5...5,5 Vdc
Output	0,5...4,5 Vdc
Connector thread	7/16" 20 UNF
Operating conditions	-40T135 °C
Connector operating conditions	-35T105°C
Protection degree	IP65
Environmental pollution level	Normal
Material in contact with the fluid	Brass or plated steel
Separation with plastic	Compatible with cooling fluids R12, R22, R134A, R404A, R407C, R410A, R502, R507, R744. Not compatible with R717 (ammonia), not to be used with water and glycol.
Clamping force	12...16 Nm

Tab. 2.i

2.6 Temperature probe

Models	NTC***HP00	NTC***HT41	NTC***HF01
Reference technical document	+030220655	+030220655	+030220655
Operating range	-50T105 °C in air - -50T50 °C in fluid	0T150 °C in air	-50T105 °C
Connections	Stripped ends, dimensions: 5±1 mm	Stripped ends, dimensions: 6±1 mm	Stripped ends, dimensions: 6±1 mm
Sensor	NTC 10 kΩ ±1% a 25 °C Beta 3435	NTC 50 kΩ ±1% a 25 °C Beta 3977	R(25 °C)= 10 kOhm 1%; Beta 3435
Dissipation factor (in air)	ca. 3 mW/°C	ca. / approx. 3 mW	3 mW
Thermal constant over time (in air)	ca. / approx. 25 s	ca. / approx. 30 s	ca. 50 s
Sensitive element index of protection	IP67	IP55	IP67
Sensitive element housing	Polyolefin	High temperature polyester dim. 20x5 mm	Thermoplastic with fastening clamp
Classification according to protection against electric shock	Basic insulation for 250 Vac	Basic insulation for 250 Vac	Basic insulation for 250 Vac
Category of resistance to heat and fire	Flame retardant	In accordance with CEI 20-35	UL/HB cable

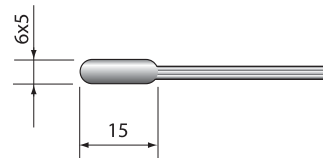

for inside showcase temperature

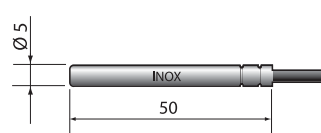

for outlet temperature

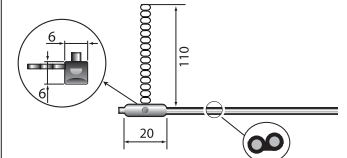

for evaporation temperature

Tab. 2.j

2.7 General connection diagram

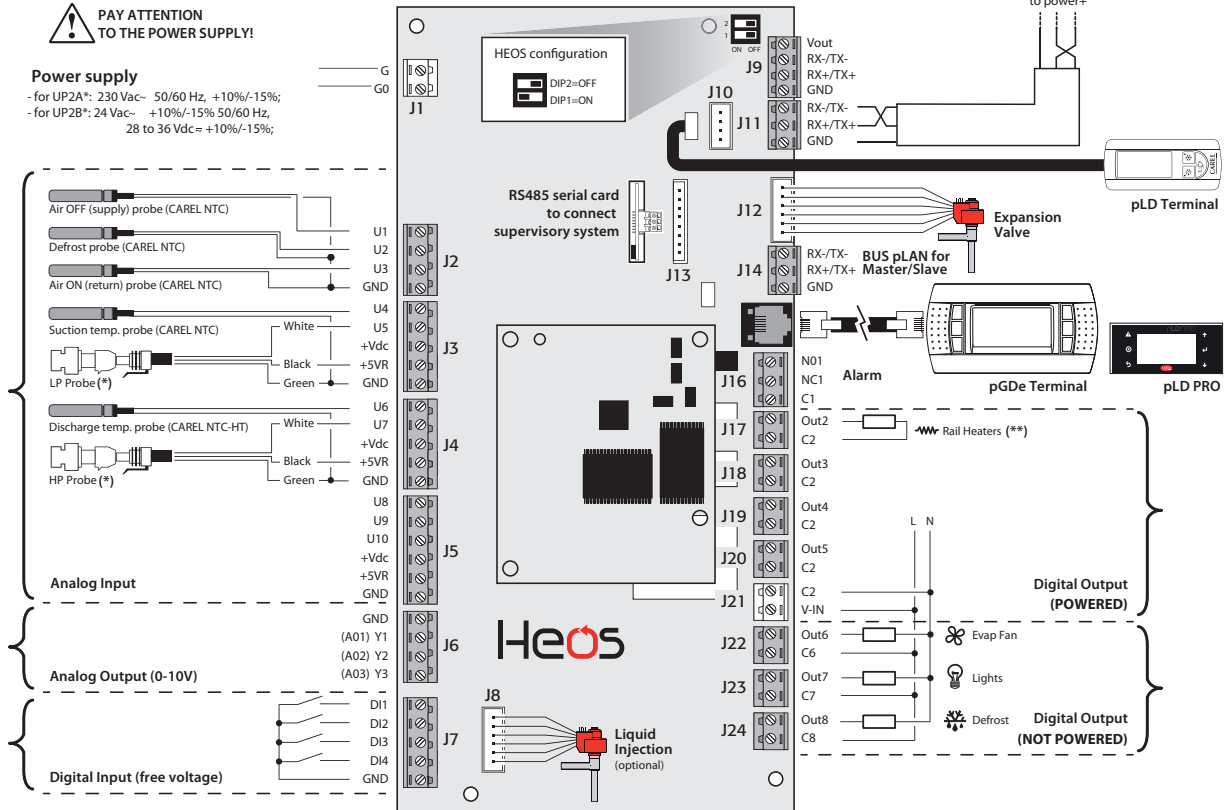
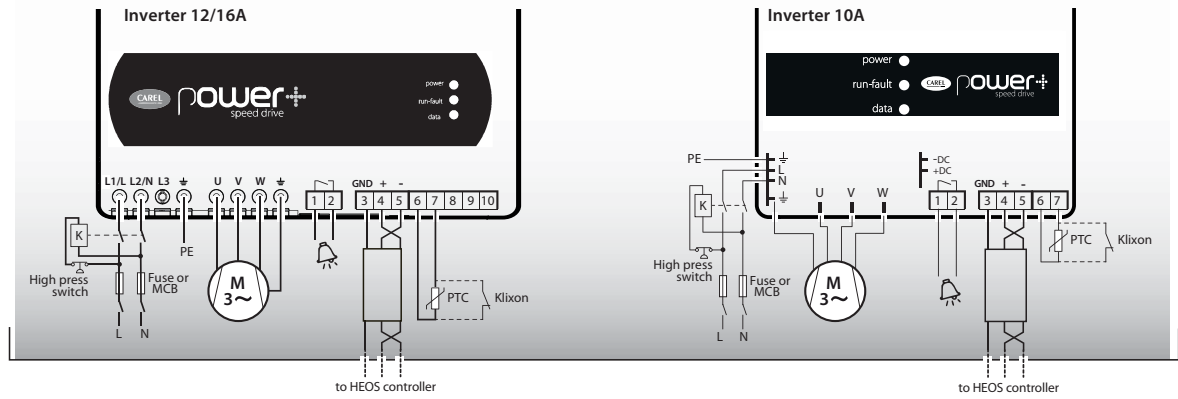

Fig. 2.d

(*) The 4-20 mA pressure probes are connected as follows: white to Ux and black to +Vdc, green not used

(**) 230 Vac SSR output, maximum switchable power 15VA

Important: Class A software: the safety devices providing overload and high pressure protection must control the compressor directly, and consequently need to be wired in series with compressor contactor control signal. For the type of cable to use, refer to power+ manual (cod. +0300048IT).

I/O selection table

Par.	Description (Analogue inputs)
/FA	Air outlet temperature (default U1)
/Fb	Defrost temperature (default U2)
/Fc	Air intake temperature (default U3)
/P3	Condensing pressure (default U7)
/P4	Suction pressure (default U5)
/P1	Discharge temperature (default U6)
/P2	Suction temperature (default U4)
/Fq	Liquid temperature
/FI	Room temperature
/FL	Room humidity
/FM	Glass temperature
/FW	Condenser water inlet temperature
/FY	Condenser water outlet temperature
/FG	Auxiliary probe 1
/FH	Auxiliary probe 2

Par.	Description (Digital inputs)
/b1	Remote alarm
/b2	Delayed remote alarm
/b3	Enable defrost
/b4	Start network defrost
/b5	Door switch
/b6	Remote ON/OFF
/b7	Curtain/light switch - day/night
/b8	Continuous cycle
/b9	Cold room maintenance
/ba	Showcase cleaning
/bb	Inverter alarm
/bc	Lights
A9	Virtual input

Par.	Description (Analogue outputs)
/LA	EC evaporator fans
/Lb	Anti-sweat heaters
/Lc	Water control valves
/Ld	Condenser pump
/LE	Auxiliary output
/LF	Water-cooled condenser output
/LG	Air-cooled condenser output

Par.	Description (Digital outputs)
/EA	Fans 1 (default DO6)
/EC	Lights (default DO7)
/Ed	Defrost heaters (default DO8)
/EE	Alarms
/EF	Auxiliary output
/EG	Anti-mist heaters
/EM	Liquid injection solenoid
/EN	Curtain contact
/Eo	ON/OFF compressor
/Er	Inverter valve output
/ES	Fan/condenser output

2.8 Functional diagrams

There are two possible showcase/cold/room configurations. The first involves the various units being fitted individually with their own compressor and condenser, meaning the showcase is completely independent, and shares the cooling water loop with the rest of the system. In the second case, the condenser is shared and consequently the Slave showcases are only fitted with the evaporator and corresponding electronic expansion valve, while the compressor is controlled by the Master board.

The system configurations can be set from a terminal (pGDe) as illustrated in the chapter on Commissioning; while on the showcase itself a PLD is normally used to display the temperature and any alarm signals.

Defrosts can be coordinated via the pLAN that controls a maximum of 6 units, or alternatively by the supervisor

1. Stand-alone configuration

In this case, each showcase/cold room has its own compressor, controlled by the corresponding board, which manages all system devices (expansion valve, showcase temperature control, alarms...).

The Master/Slave network is used for to coordinate defrosts, lights and curtain switch; otherwise these functions must be managed by the supervisor.

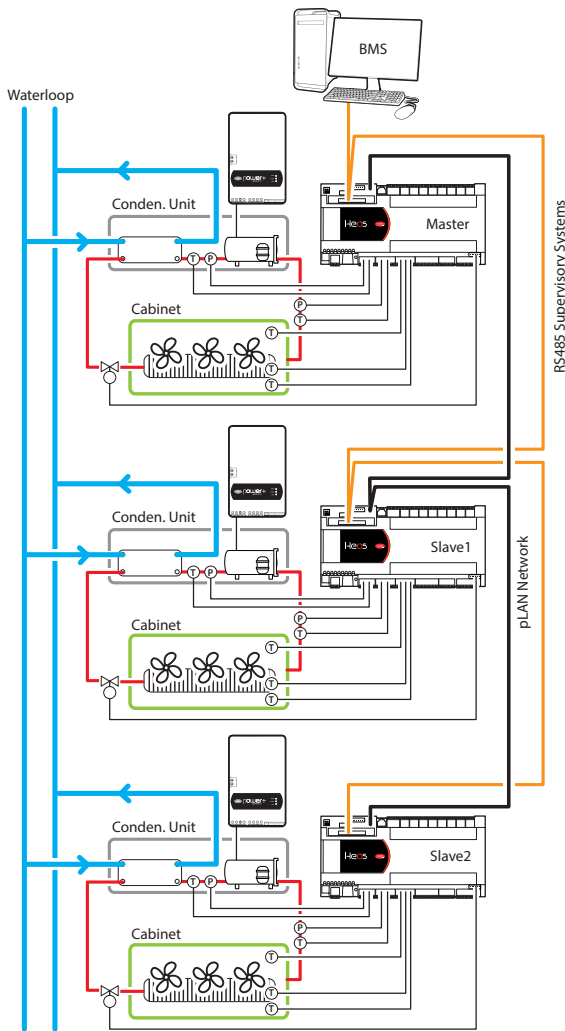

Fig. 2.e

Note: For the electrical connections, see the general connection diagram in par. 2.9. If a master/slave network or multi-evaporator pLAN is configured, the controller addresses should be set following the procedure shown in chapter 9.1 or using the Wizard (chap. 5 "Commissioning")

2. Multi-evaporator Master/ Slave network

The Master controller manages the compressor and coordinates the functions of the 5 Slave controllers connected via the pLAN. Each Slave controller manages the individual showcase and has a PLD user terminal for temperature monitoring. Each controller, both Master and Slave, is connected to the supervisor network. The Master only shares the evaporation pressure, and not the corresponding temperature.

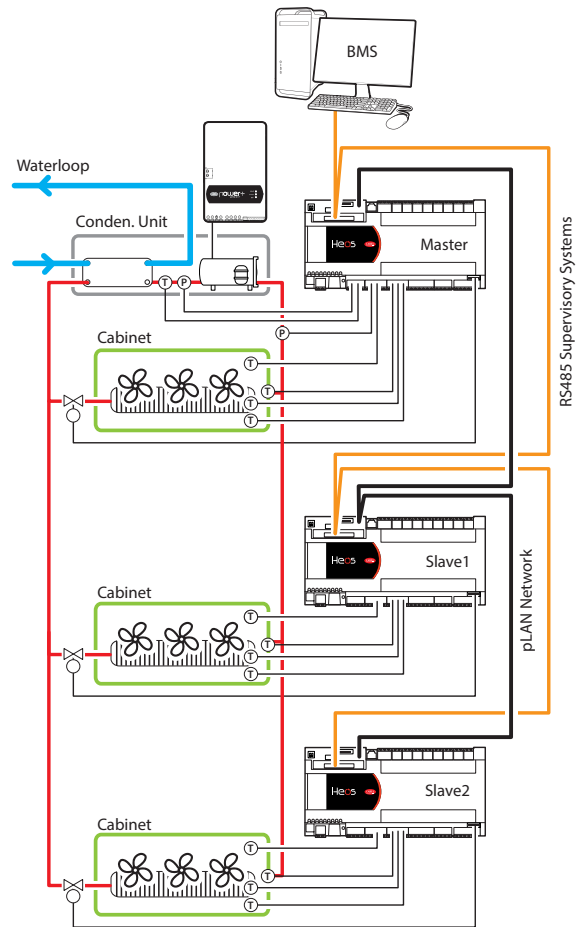

Fig. 2.f

3. RS485 supervisor network

A maximum of 199 number Heos controllers (Master or Slave) can be connected to the supervisor network (via CAREL or Modbus® protocol).

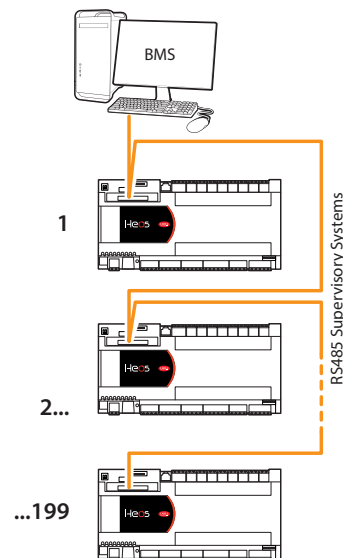

Fig. 2.g

Supervisor network layout with various Heos controllers connected, 1-199

2.9 Installation

For installation, proceed as follows, with reference to the wiring diagrams:

- before performing any operations on the control board, disconnect the main power supply by turning the main switch in the electrical panel OFF.
- avoid touching the control board with bare hands, as any electrostatic discharges may damage the electronic components;
- suitable electrical protection must be ensured by the manufacturer of the showcase or by appropriate installation of the controller;
- use a B or B+ residual current circuit breaker when the compressors are controlled by inverter; these protection devices must always be installed always upstream of the AC/A/F (see the figure below)

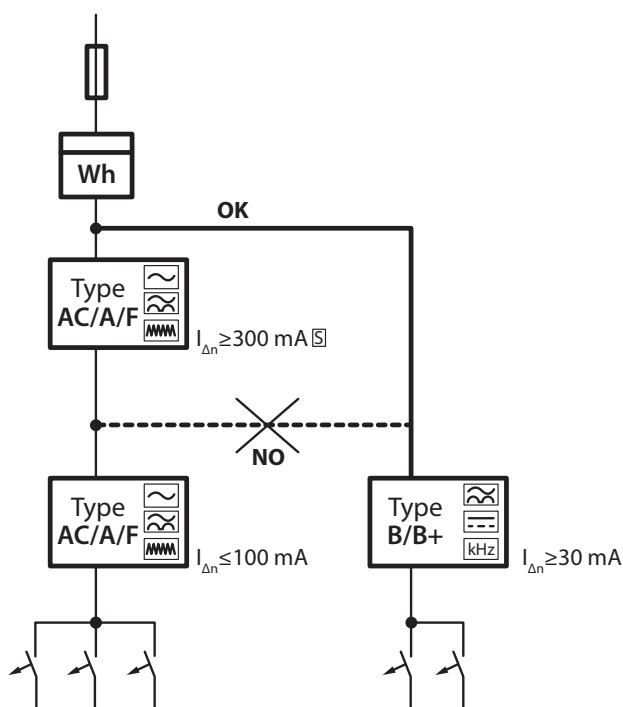

Fig. 2.h

- connect any digital inputs, $L_{max}=10\text{ m}$;
- connect the temperature and pressure probe, $L_{max}=10\text{ m}$;
- connect the electronic expansion valve cable to connector J12;
- connect the inverter serial communication cable (if used) to terminal J11;
- connect the optional PGDe terminal (needed for commissioning) to connector J15;
- connect the optional PLD terminal to connector J10;
- connect power supply to controller and the inverter, if used;
- program the controller using the guided commissioning procedure: see the chapter on Commissioning”.
- Program the individual controllers using the Wizard (also used to assign the pLAN address) and then connect the controllers in the same pLAN Master/Slave group together, using connector J14. For connection, use a shielded cable and make sure that the maximum distance between consecutive controllers is 100 m (minimum cable size AWG22);
- connect the electrical loads to the relay outputs only after having programmed the controller. Always carefully evaluate the maximum capacity of the output relays, as specified in the Technical specifications;
- connect the supervisor serial line to the card inserted on connector J13.

! Important: avoid installing the controllers in environments with the following characteristics:

- relative humidity greater than 90% or with condensation;
- strong vibrations or knocks;
- exposure to water sprays;
- exposure to aggressive and polluting atmospheres (e.g.: sulphur and ammonia fumes, saline mist, smoke) to avoid corrosion and/or oxidation;
- strong magnetic and/or radio frequency interference (therefore avoid installing the devices near transmitting antennae);
- exposure of the controllers to direct sunlight and to the elements in general.

! Important: the following warnings must be observed when connecting the controllers:

- incorrect power connections may seriously damage the controller;
- use cable ends suitable for the corresponding terminals. Loosen each screw and insert the cable ends, then tighten the screws and gently tug the cables to check they are sufficiently tight;
- separate as much as possible the probe and digital input cables from cables to inductive loads and power cables, so as to avoid possible electromagnetic disturbance. Never run power cables (including the electrical panel cables) and probe signal cables in the same conduits;
- do not run probe signal cables in the immediate vicinity of power devices (contactors, circuit breakers, etc.);
- reduce the path of probe cables as much as possible, and avoid spiral paths that enclose power devices.

! Important: Class A software: the safety devices providing overload and high pressure protection must control the compressor directly, and consequently need to be wired in series with compressor contactor control signal.



Note: when connecting the RS485 serial network:

- connect the shield to the GND terminals on all controllers;
- do not earth the shield on the electrical panel;
- use shielded, twisted cable and (e.g. Belden 3106A – AWG 22);
- For the supervisor serial network (J13): connect a 120 Ω terminating resistor between the Tx/Rx+ and Tx/Rx- terminals on the last controller in the network (the one furthest away from the supervisor). Do not connect any resistors to the pLAN Master/Slave network connectors (J14).

3. USER INTERFACE

The Heos system can be used with two types of display: one, the pGDe, for commissioning and/or to access all the control parameters; the other, PLD, for displaying the cabinet temperature and any alarms.

Note: the PLD terminal can only be used if the pGDE terminal is disconnected (both cannot be used at the same time).

3.1 pGDe and pLDPRO Keypad

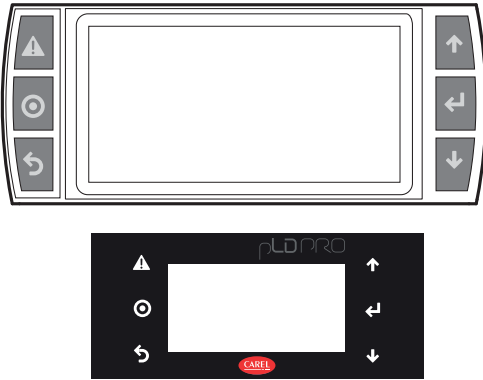

Button	Function
	Alarm displays the list of active alarms
	Prg used to enter the main menu tree
	Esc returns to the higher level screen
	scrolls a list upwards or increases the value highlighted by the cursor from the "main" screen, accesses the INFO screens
	scrolls a list downwards or decreases the value highlighted by the cursor from the "main" screen, accesses the INFO screens
	enters the selected submenu or confirms the set value from the main screen, accesses the "DIRECT COMMANDS" screens (index: Ab01-03)

3.2 "Main" mask

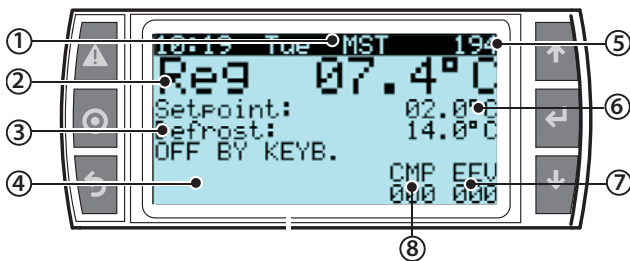
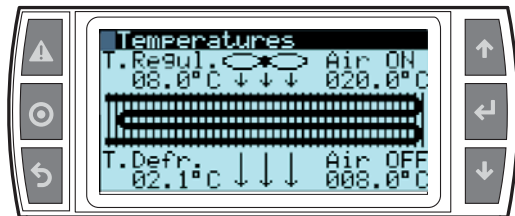
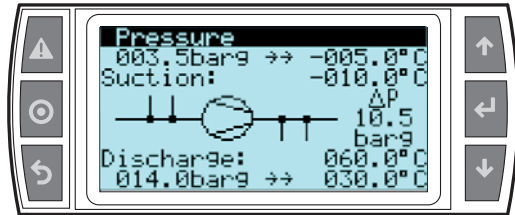
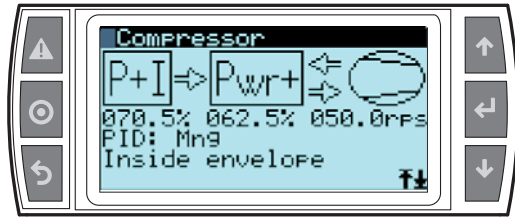

Fig. 3.a

Ref.	Function
1	Active Master/Slave board;
2	Control temperature;
3	Defrost probe temperature
4	Output status: • compressor • evaporator fan • light • continuous cycle • anti-sweat heaters
5	Serial address;
6	Active set point;
7	% of electronic expansion opening valve;
8	% of compressor speed

Below are some examples of the INFO screens, directly accessible from the main screen:



3.3 PLD terminal

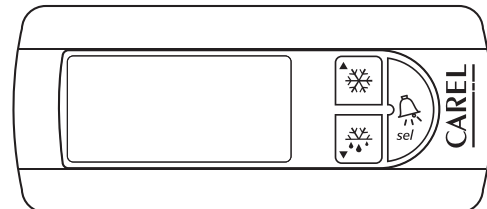

Fig. 3.b

Button	Function
	UP scroll a list upwards or increases the value shown on the display;
	DOWN scrolls a list downwards or decreases the value shown on the display;
	accesses the set point for modification and mutes the buzzer if an alarm is active.

Switch system on/off: hold the button for a few seconds, until the system status parameter ("oFF" / on) is shown;

- to switch on/off, press .

- to exit the parameter, press and .

Change set point and switch lights on/off: from the main screen, press

and hold and together for a few seconds, until "SET" is shown;

then use or to select the parameter, "LIG" or "SET" and press to change the setting (again using and). To exit the menu, press and .

Start a defrost: press and hold for a few seconds; when the button backlighting comes on, the defrost starts.

4. MENU DESCRIPTION

4.1 Main menu

To access the menu tree, press  from the main screen; the "enter password" screen is displayed.

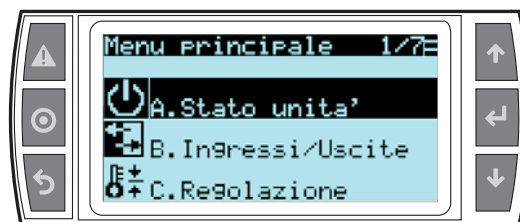







Once having entered the correct password (default value 123), the first main menu screen will be displayed.

! Important:

- the password User; Service; Manufacturer is set in branch Ee01-03;
- if no button is pressed while navigating the menu tree, after 5 minutes the main screen is automatically displayed again.

To navigate inside the menu tree, use the following buttons:

-  and : navigate around the submenus, screens and change values and settings;
- : confirm and save the changes made;
- : to return to the previous menu

	A. Unit Status	a. On/Off		Aa01-02	U
		b. Direct Commands		Ab01-03	U
	B. Input/Output	a. Configuration	a. Analog In.	Baa01-16	M
			b. Analog Out	Bab01-07	M
			c. Dig. In.	Bac01-14	M
			d. Dig. Out	Bad01-14	M
		b. Manual Management	Bb01-05	M	
	C. Regulation	a. Setpoint		Ca01-05	U
		b. Night regulation	a. Regulation	Cba01	U
			b. Scheduler	Cbb01-03	U
		c. Setpoint config.		Cc01-02	S
	D. Functions	a. Compressor	a. Regulation	Daa01-11	M
			b. Configurazion	Dab01-12	M
			c. Power+	Dac01-22	M
			d. Alarms	Dad01-06	M
			e. Diagnostic	Dae01-07	M
		b. EEV	a. Regulation	Db01-02	S
			b. Configuration	Dbb01-03	M
			c. Safety Procedures	Dbc01-07	M
		c. Defrost	d. Diagnostic	Dbd01	M
			a. Configuration	Dca01-10	S
			b. Scheduler	Dcb01-04	S
		c. Special Functions		Dcc01-04	S
		d. Fans		Dd01-04	M
e. Rail Heaters		De01-07	M		
f. Generic Functions		Df01	M		
	E. Configuration	a. Communication		Ea01-03	S
		b. M/S-Multielevator		Eb01-07	M
		c. Display		Ec01-04	S
		d. Clock		Ed01-02	U
		e. Password		Ee01-03	M
		f. Default		Ef01-02	M
	F. Alarms	a. Compressor		Dad01-06	M
		b. EEV Safeties		Dbc01-07	M
		c. Temperature		Fc01-05	S
		d. History		Fd00-50	U
	G. Diagnostic	a. Compressor		Dae01-07	M
		b. EEV		Dbd01	M

Tab. 4.a



5. START-UP



5.1 Guided commissioning procedure

The Heos controllers can be setup the first time from the pGDe user terminal connected to J15. After programming, the terminal can be removed or remain connected.

If the controller has not yet been configured, the user terminal shows the language selection and then the first screen in a guided configuration procedure, called the "wizard". Otherwise, the same menu can be accessed from branch.

E.Configuration>>f.default.

The main parameters needed for general configuration are shown one at a time. The wizard screens are all numbered in the top right corner; the following explanations refer to this number. To go from one screen to the next press , while to return to previous screen press .

 **Important:** at the end of the procedure, exit by powering the unit OFF, after having exited screen WZ19 by pressing .

Screen WZ01: this shows the code of the application loaded on the controller (FLSTDmWLOM) and the revision. Pressing  starts the guided procedure.



Screen WZ02: select multi-evaporator/individual compressor configuration. A group of controllers is called "multi-evaporator" when multiple controllers (up to 6) are connected in a Master/Slave network, and share the same compressor, controlled by the Master. If setting "Y" for the parameter on this screen, the unit will be part of a multi-evaporator group. Setting "NO", the unit is configured as stand-alone or part of a Master/Slave group with an individual compressor on each unit.

Screen WZ03: unit address. The unit can be configured as the Master or as one of the Slaves, setting the parameter to MASTER or SLAVE1, SLAVE2, ... SLAVE 5. Setting this parameter also sets the controller pLAN address as a consequence: 1 for the Master, 2 for Slave 1, 3 for Slave 2, and so on up to 6 for Slave 5.

Screen WZ04: this is only shown if the controller is set as the Master and the multi-evaporator configuration has been selected. This specifies the number of evaporators connected to the Master. The default value is the number of Slaves connected.

Screen WZ05: this is only shown if the controller is set as the Master and the multi-evaporator configuration has not been selected. specifies the number of Slaves connected to the Master.

Screen WZ06: evaporator capacity. If the unit is configured as part of a multi-evaporator group, this screen is used to set the rated evaporator cooling capacity. This data is used to adjust the compressor speed based on demand from the various units served.

Screen WZ07: select type of unit. The type of unit can be selected as SHOWCASE or COLD ROOM. If COLD ROOM is selected, other parameters are proposed: the position of the door switch and enable/disable the three temperature probes: outlet, defrost and intake.

Screen WZ08: select type of unit of measure (SI or Imperial).

Screen WZ09: set point and virtual probe composition. This screen is used to set the control set point and the weight of the outlet and intake temperature probes in the average for calculating the control temperature. When the parameter is set to 0%, the virtual probe coincides with the outlet probe, if set to 100% the virtual probe coincides with the intake probe.



Screen WZ10: select type of compressor, BLDC or ON/OFF.

Screen WZ11: select compressor and inverter programming. For the Compressor parameter, any one of the compressors managed by Heos can be selected. Under the type of compressor, if the inverter is connected and on, the model of Power+ can be read. If the inverter is off or not connected, the last row of the screen displays the message Power+ not connected. After having confirmed the type of compressor, if communication with the inverter is active, Write parameters is displayed; choosing Y starts writing some of the parameters to the inverter, so as to ensure correct operation with the selected compressor. During the write procedure, the display shows Installing parameters..., replaced by a confirmation message when the write procedure has ended. If the control is fitted on a Slave on a multi-evaporator unit, this screen is not displayed.

Screen WZ12: select type and limits of the suction and condensing pressure probes.

Screen WZ13: with on-board compressor, if configuring a Slave in on a multi-evaporator unit, only the suction probe is proposed.

Screen WZ14: select the type of outlet, defrost, intake, compressor suction and compressor discharge temperature probes. If is a Slave unit being configured, the compressor discharge temperature probe is not displayed.

Screen WZ15: select the type defrost and main defrost parameters.

Screen WZ16: select the operating mode for the evaporator fans.

Screen WZ17: set the parameters for connecting the supervisor.

Screen WZ18: end the wizard procedure. Pressing ENTER ends the procedure, and starts configuring the system with the chosen options. At the end of the configuration, the controller needs to reset the unit to confirm the data (WZ19). Power down the controller for a few seconds and power on again.



6. FUNCTIONS

If the settings made using the wizard (commissioning) are not sufficiently detailed, the I/Os can be configured individually in branch **B.a.xx** (inputs/outputs).

 **Note:** many parameter codes, for uniformity, are the same as used on the MPXpro controller (manual +0300055EN). In this case, the pGDE shows a complete description of the parameters.

6.1 Probes (analogue inputs)

Heos features 10 universal analogue inputs (U1, U2, ... U10) which can be configured for the functions shown in the following table. The first seven (U1-U7) relate to the main probes and are configured by default; the other three inputs are optional, and can be associated with other functions.

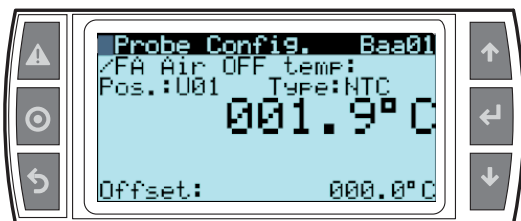

List of selectable functions

Par.	Description
/FA	Air outlet temperature (default U1)
/Fb	Defrost temperature (default U2)
/Fc	Air intake temperature (default U3)
/P3	Condensing pressure (default U7) (*)
/P4	Suction pressure (default U5) (*)
/P1	Discharge temperature (default U6) (*)
/P2	Suction temperature (default U4)
/Fq	Liquid temperature
/Fi	Room temperature (SA)
/FL	Room humidity (SU)
/FM	Glass temperature
/FW	Condenser water inlet temperature
/FY	Condenser water outlet temperature
/FG	Auxiliary probe 1
/FH	Auxiliary probe 2

(*) Slave units in a multi-evaporator system do not have their own compressor. Consequently, the discharge pressure and temperature probes are not used.

These inputs can be connected to temperature, pressure and humidity probes, as shown in the table below:

Temperature
NTC (-50T90°C; R/T 10 kΩ±1% @ 25°C)
NTC HT (0T150°C)
PT1000 (-100T400°C)
PT500 (-100T400°C)
PT100 (-100T200°C)
PTC (600Ω ...2200Ω)
Pressure
4-20mA
0-5V ratiometric
Humidity
4-20mA
0-1V
0-10V

Tab. 6.a

Active probes (voltage or current) can be powered directly by Heos (see the chapter on connections). For all these probes, the range of measurement needs to be configured on the corresponding screen.

Heos can modify the values read by the probes by applying a settable offset directly in the screen used to associate the function to the input. Serial probes cannot be calibrated, while probes that are shared with the Master (such as the common pressure probe for multi-evaporator systems) are calibrated on the Master. Only one pressure probe can be shared across the Master/Slave network in multi-evaporator mode, and must only be connected to the Master. Simply correctly configure the probe in the corresponding screen and then on the Slaves, in the same screen, select the "shared" probe option. In this way, the Slaves will automatically look for the pressure value shared by the Master and use this to calculate local superheat. This saves the cost of installing a pressure probe on each evaporator, assuming that the pressure drop on of line in the corresponding section is negligible.

The room temperature and humidity probes must not be positioned too far from the corresponding showcases. At times it is better to install more than one if the supermarket is divided into zones with different temperature and humidity (frozen foods, meat, fruit and vegetables, etc.): **glass temperature probe:** NTC060WG00. The glass temperature probe is connected at the coldest point of the glass on the showcase, so as to optimise operation of the anti-sweat device (heaters or fans). See instruction sheet +050002005.

Master/Slave system (see functional diagram for stand-alone configuration on page 3)

Up to 6 units can be connected together in a Master/Slave configuration, where the Master synchronises the defrosts and the night/day transition for the entire group, and shares the suction pressure reading. Communication between units in the same Master/Slave group is managed over a pLAN sub-network connected to terminal J14 on each controller.

Multi-evaporator system (see functional diagram for multi-evaporator Master/Slave network on page 13)

In a Master/Slave system, just one compressor can be used, connected to the Master, to serve the evaporators on the Slaves. This is called a multi-evaporator system. One condensing unit can be connected to up to six evaporators (including the Master). Each evaporating unit will be fitted with a controller, electronic expansion valve, air temperature probes, refrigerant superheat temperature probe (evaporator outlet) and evaporator outlet pressure probe. On the controllers, the cooling capacity of each unit needs to be set (parameter PE2) and multi-evaporator mode must be activated on both the Master and the Slaves (parameter PE1 > 1). On multi-evaporator systems, the Master suction pressure probe reading can be shared and used to calculate the superheat on the Slaves (configured by default).

6.2 Digital inputs

Heos manages four physical digital inputs, which can be selected as shown below. There is also the possibility to use a virtual digital input, propagated via pLAN from Master to Slaves. This is useful, for example, for a curtain switch, as the units can switch from daytime to night-time operation and vice-versa without needing additional wiring between the Master and the Slaves. The virtual digital input can be set on the Master, using parameter A9, and will be propagated to the Slaves by selecting "Virtual DI".

For example, if there is a Heos configured as Master and another as Slave, DI1 on the Master will be connected to the door switch, and its status will be shared with the Slave:

- on the Master, set parameter A9 to DI1;
- on the Slave, on the Door switch input configuration screen, select "Virtual DI".

Functions available for the digital inputs

For each function, there is a configuration screen used to associate it with an available digital input. The same screen is used to select the input configuration (normally open or normally closed). The status (Open or Closed) displayed is the effective position of the input, while the function is associated with the selected logic. When the input is in the physical status specified as "normal" in the logic, the function is "Not active", when the input is in the opposite physical status, the corresponding function is "Active".

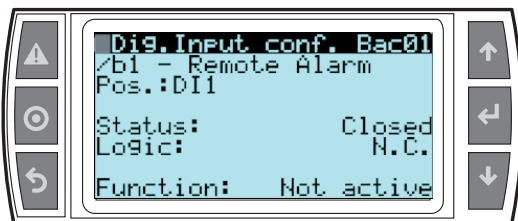

List of selectable functions

Parameter	Description
/b1	Remote alarm
/b2	Delayed remote alarm
/b3	Enable defrost
/b4	Start network defrost
/b5	Door switch
/b6	Remote ON/OFF
/b7	Curtain/light switch - day/night
/b8	Continuous cycle
/b9	Cold room maintenance
/bA	Showcase cleaning
/bb	Inverter alarm
/bC	Lights
A9	Virtual input

Remote alarm (immediate)

Activation of the input causes:

- alarm message shown on the display
- activation of the buzzer
- activation of the alarm relays (if configured, see digital outputs);
- deactivation of the compressor.

Note: When the compressor is shut down due to a remote alarm the minimum compressor ON time (parameter c3) is ignored.

Remote alarm with activation delay

Operation of this alarm depends on the setting of parameter A7 (delay time for delayed remote alarm):

A7=0: signal only alarm on the display, normal operation of the controller is not affected (default);

A7≠0: alarm similar to the remote alarm (immediate), activation is delayed by the time set for A7.

Enable defrost

Used to disable any defrost calls. When the contact is open, all defrost calls are ignored. Parameter d5 can be used to delay activation.

Start network defrost

Closing the digital contact starts the defrost, if enabled. In the event of Master/Slave network connection, if the controller is the Master, the defrost will be a network defrost (i.e. will also involve all the Slaves), while if it is a Slave, it will only be a local defrost. The defrost digital input can be used effectively to perform real time defrosts. Simply connect a timer to the multifunction digital input on the Master and use d5 to delay the defrosts on the various Slaves and thus avoid current overloads.

Door switch

With the door open (switch active) the following occur:

- Lights on
- Fans off
- The delayed alarm counter starts (parameter d8)
- The message "DOR" is shown on the PLD display

For stand-alone evaporator units:

- Compressor off (without deactivation ramp, cooling demand is not reset, but continues to be calculated)

For multi-evaporator units:

- Compressor cooling demand continues to be calculated, however the component relating to the unit with the door open is reset
- Expansion valve closed

When the door is closed:

- Lights off
- Fans on

For stand-alone evaporator units:

- The compressor is restarted as normal

For multi-evaporator units:

- The component of demand relating to the unit whose door was open is used again in the calculation
- The expansion valve resumes operation (pre-positioning as at start-up)

Note:

- when resuming control, the compressor protection times are observed;
- if the door remains open for a time greater than the value set for parameter d8, control is resumed in any case. The light remains on, the buzzer and the alarm relay are activated, and the temperature alarms are enabled, with the delay Ad.

Par.	Description	Def	Min	Max	UOM
d8	High temperature alarm bypass time after defrost and door open	30	1	240	min

Remote ON/OFF

Switches the controller off via the digital input. The PLD displays the value measured by the selected probe (parameter /t2) alternating with the message OFF; switch ON commands from the keypad or supervisor are ignored.

Note:

- if more than one input is configured as the remote ON/OFF, the off status of one any of these switches the controller OFF;
- the OFF control from digital input has priority over the keypad and the supervisor;
- if the controller remains OFF for longer than the value set for basic parameter (time between consecutive defrosts), when the controller is switched back on a defrost is performed.

Curtain/light switch

The curtain switch is used to control night/day status via a digital input. When the switch is active (open if NC, closed if NO), the status is set to NIGHT, when the switch is not active, the status is DAY.

- During Night status, the night-time set point Stn is used for control, calculated based on the set point St plus the offset defined by parameter r4 (Stn = St + r4). If r4 is negative, during Night status the effective set point is decreased from the Day set point.
- In addition, if necessary the control probe is changed based on the setting of parameter r6 (0 = virtual probe, 1= intake probe); the light is switched off.
- During Day status: normal operation resumes, set point = St, the virtual probe used as the control probe; the light output is activated.

Cold room maintenance

The logic is the same as the door switch, and activation is as follows:

- Door opens: stop control in the same way as the door switch.
- Door closed again: ignored
- Door opened again: control resumes, same as when closing the door switch
- Door closed again: ignored

Showcase cleaning

When the contact closes, control stops, while the lights and probe alarms are enabled. When the contact opens again, or after a maximum time (parameter bA1 - screen Df01), control resumes.

Inverter alarm

This has the same functions as the remote alarm, and is connected to the inverter alarm output.

Lights

Lights On/Off, if the lights are controlled by time band, or day/night status, this function has higher priority.

6.3 Analogue outputs

Heos features three analogue outputs (0-10 V), which can be associated with the following functions.

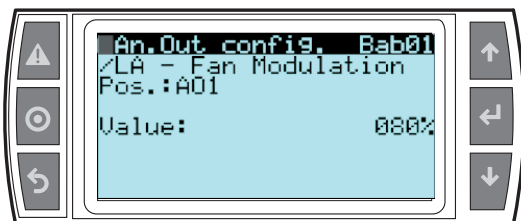

List of selectable functions

Par.	Description
/LA	EC evaporator fans
/Lb	Anti-sweat heaters
/Lc	Water control valves (not enabled)
/Ld	Condenser pump (not enabled)
/LE	Auxiliary output (not enabled)
/LF	Water-cooled condenser output
/LG	Air-cooled condenser output

6.4 Digital outputs

Heos features eight digital outputs, configurable as shown in the following table.

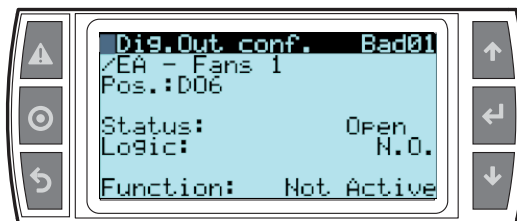

List of selectable functions

Par.	Description
/EA	Fans 1 (default D06)
/Eb	Fans 2
/EC	Lights (default D07)
/Ed	Defrost heaters (default D08)
/EE	Alarms
/EF	Auxiliary output
/EG	Anti-sweat heaters
/EM	Liquid injection solenoid
/EN	Curtain contact
/Eo	ON/OFF Compressor
/Er	Inverter valve output
/ES	Fan/condenser output

Normally de-energised/normally energised alarm

A relay configured as an alarm may be set as:
 normally de-energised: the relay is energised when an alarm occurs;
 normally energised: the relay is de-energised when an alarm occurs.



Note: operation with the relay de-energised when an alarm occurs ensures maximum safety when the alarm is due to a power failure or disconnection of the power cables.

6.5 Control

There are various modes for controlling air temperature for the conservation of foodstuffs in cold rooms and showcases. The following figure shows the position of the intake probe Sr and the outlet probe Sm. The virtual probe Sv is a weighted average of these two, based on parameter /4, according to the following formula:

$$S_v = \frac{S_m \cdot (100 - /4) + S_r \cdot (/4)}{100}$$

Par.	Description	Def	U.M.	Min	Max
/4	Virtual probe composition (weighted average Sr, Sm)	0	%	0	100

For example if /4=50, Sv=(Sm+Sr)/2 represents the average value of the air temperature.

Example: vertical showcase

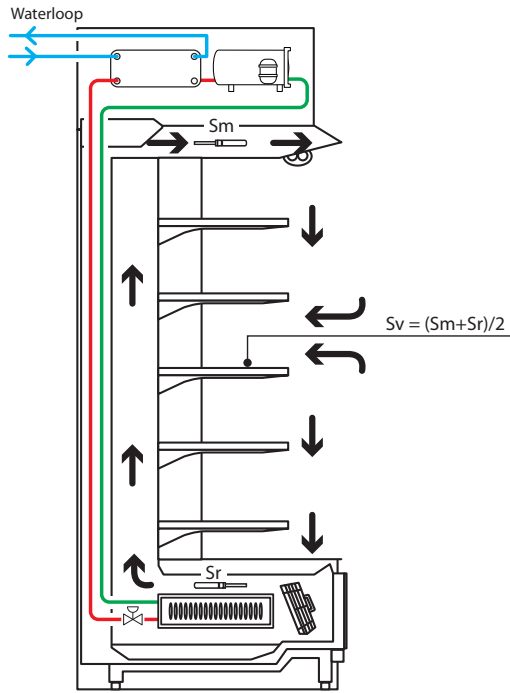

Fig. 6.a

Key

Sm	Outlet probe	Sr	Intake probe	Sv	Virtual probe
----	--------------	----	--------------	----	---------------

During the day most of the load of the showcase is due to the warm air that enters from the outside and mixes with the cool air inside. Control based on the intake probe, due to high temperature outside the showcase and the mixing of the air, may not manage to reach the set point. Displaying the intake temperature would show a temperature that is too high. Setting a set point that is too low for the intake probe Sr may cause the food to freeze. On the other hand, displaying the outlet temperature would show a temperature that is too low. Consequently, the display (on the PLD) of the control probe, set point or virtual probe can be configured using parameter /t2.

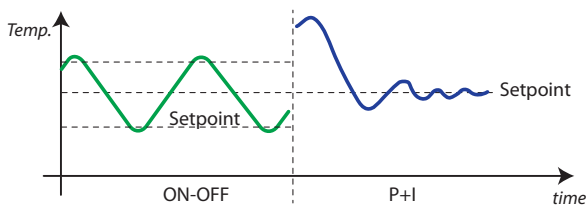

Fig. 6.b

Temperature control of the refrigeration unit is managed using a proportional + integral (P+I) algorithm. Based on the difference between control temperature and set point (proportional error) and the trend in this difference over time (integral error), the controller varies the request for cooling capacity on a scale from 0 to 100%. Depending on the model of compressor installed, this percentage is converted to an operating speed, expressed in revolutions per second (rps). To adapt control to the characteristics of the refrigeration unit, the proportional gain (Kp) and integral time (tl) can be adjusted. Kp represents the percentage of increase in cooling request according to the deviation from the set point [%/°C], tl represents the time interval to evaluate the variation and the trend in the integral error. High values of Kp lead to higher variations in request for the same variation in control temperature (Treg), high values of tl lead to smaller variations in request over time.

Par.	Description	Def	U.M.	Min	Max
Kp	Temperature control differential	10	%/°C	1	200
tl	Compressor control integral time	500	s	0	999

Night-time operation

During night-time operation, the curtain on the showcase is closed and consequently less cold inside air is mixed with warm outside air. The thermal load decreases. The temperature of the air that cools the produce is near the outlet temperature, and therefore to avoid excessively low temperatures and reduce energy consumption, the set point needs to be increased at night, by setting parameter r4. Parameter r6 can then be used to assign the virtual probe Sv or intake probe Sr as the control probe. The change to night-time operation must be signalled externally. This is done using the curtain switch (set using the parameters relating to the digital inputs) or by setting time bands (S1...S3), or from the supervisor, or using a command from the Master via the Master/Slave network. Night-time status is activated by the transition of the assigned digital input from "Not active" to "Active". Vice-versa, a transition from "Active" to "Not active" changes back to daytime status. If, when the digital input is active, the signal is sent to change to daytime status by the supervisor or one of the other possible sources, the controller switches to daytime status. In other words, none of the sources has higher priority than the others, rather the status depends on the most recent command.

Par.	Description	Def	U.M.	Min	Max
r4	Set point offset in night mode	3.0 (5.4)	°C (°F)	-50.0 (-90.0)	50.0 (90.0)
r6	Enable night-time control on intake probe (Sr)	0	-	0	1
hS1/mS1	Start time band 1 (hours/minutes)	-	-	-	-
hE1/mE1	End time band 1 (hours/minutes)	-	-	-	-

During daytime status: Set point= St
light on
control on virtual probe Sv (Treg)

During night-time status: Set point= St + r4
light off
control on Sr (se r6= 1) or Sv (if r6= 0)

Minimum and maximum set point value (parameters r1 and r2)

A parameter can be used to define the minimum and maximum possible values for the set point.

Par.	Description	Def	U.M.	Min	Max
r1	Minimum control set point limit	-50.0 (-58.0)	°C (°F)	-50.0 (-58.0)	max
r2	Maximum control set point limit	50.0 (122.0)	°C (°F)	min	50.0 (122.0)

ON/OFF

Parameter O/F is used to switch the controller ON/OFF. Any digital input configured as the remote ON/OFF signal has higher priority than the signal from the supervisor or the parameter.

Par.	Description	Def	U.M.	Min	Max
O/F	Select unit status	0	-	0	1

If more than one digital input is selected as ON/OFF, ON status will be activated when all the digital inputs are inactive. The unit is OFF even if just one of the contacts is activated. When switching from ON to OFF and vice-versa, the compressor protector times are observed.

When OFF, the following are possible:

- access all the configuration parameters;
- activate remote ON/OFF.

When OFF, the following alarms are reset:

- high and low temperature;
- open door (dor);
- expansion valve alarms LSA, LowSH, MOP).

Control offset with probe error (parameter r0)

By default, Heos uses the virtual probe Sv for control, that is, the weighted average of the outlet and intake probe (see parameter /4). If one of the two probes making up the virtual probe is broken or has an error, parameter r0 is used to continue normal control in controlled conditions, without the need for an immediate response by maintenance personnel.

Par.	Description	Def	U.M.	Min	Max
r0	Control offset with probe error	5.0 (9.0)	°C (°F)	0.0 (0.0)	20.0 (36.0)

The recommended value of r0 is the temperature difference between the outlet probe and intake probe reading in steady refrigeration unit operating conditions:

$$r0 = \frac{Sr - Sm}{100}$$

The following two cases may occur:

outlet probe Sm error: starts control based on the intake probe Sr alone, considering a new set point (St*) determined by the formula:

$$St^* = St + r0 \cdot \frac{(100 - /4)}{100}$$

intake probe Sr error: Heos starts control based on the outlet probe Sm alone, considering a new set point (St*) determined by the formula:

$$St^* = St - r0 \cdot \frac{(100 - /4)}{100}$$

If night-time operation has been set with the intake probe as the control probe, the controller considers /4=100 and uses the outlet probe. The new set point becomes:

$$St^* = \frac{St - r0}{100}$$

Note:

- if an error occurs on both probes, the controller switches to duty setting operation, see below.

Example: Sm fault in daytime operation, with /4=50, St=-4, Sr=0, Sm=-8, r0 (recommended) = 0-(-8) = 8. Then the new control probe will be Sr with: St* = -4+8 ·(100-50)/100=0

If the fault is on Sr, the new control probe will be Sm with: St* = -4-8 ·50/100=-8.

Duty setting operation (parameter c4)

Duty setting is a special function used to maintain control in emergency situations with errors in the temperature control probes, until a service callout is possible. In the event of a temperature probe error, Heos uses the other probe available and adjusts the set point according to the setting of parameter r0. In the event of errors on both probes, Heos switches to duty setting mode. The controller is activated at regular intervals, operating for a time equal to the value set for the duty setting parameter c4, and off for a time equal to c5. Compressor speed is fixed, at the value set for c3.

Par.	Description	Def	U.M.	Min	Max
c3	Compressor capacity percentage with probe alarm	50	%	0	100
c4	Comp. on time in duty setting from probe alarm	5	min	0	100
c5	Comp. off time in duty setting from probe alarm	5	min	0	100

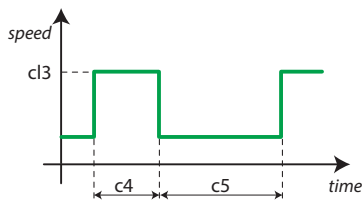

Fig. 6.c

Important: during duty setting, the compressor protection times are not observed.

The table below describes the possible fault situations relating to the control probes and the function that is activated.

Type of system	Control probe fault		Control	Parameter
1 probe	Sm	Sr		
	<input type="checkbox"/>	<input type="checkbox"/>	Duty setting	c4
2 probes	<input type="checkbox"/>	<input type="checkbox"/>	Duty setting control with Sr	r0(*)
	<input type="checkbox"/>	<input type="checkbox"/>	control with Sm	r0(*)
	<input type="checkbox"/>	<input type="checkbox"/>	Duty setting	c4

* r0 must be >0.

Multi-evaporator system control

Each evaporating unit has its own cooling capacity (parameter PE2). Compressor speed is calculated based on the average between the difference between the control temperature and the set point on each unit, weighed according to the cooling capacity of each evaporator. If there are three evaporators, the total error E_TOT that the P-I control algorithm will use to calculate the output depends on the cooling capacities of the three units (PM, PS1, PS2).

The E_TOT calculated in this way is applied to a P+I algorithm so as to determine the required percentage of cooling capacity, which translates into the required compressor speed.

Superheat modulation (multi-evaporator)

On showcases where active, the superheat set point varies between the user setting (P3) and an offset (PE7) with P+I logic, so as to correctly manage the control temperature. As the control temperature approaches the set point, the superheat set point is increased, so as to further close the expansion valve. To activate this function, set the offset PE7 to a value greater than 0.

Duty setting with multi-evaporator

Activation of duty setting mode on the Master controller implies that the compressor management times set for the Master controller are also used by all the connected Slaves. The Slaves will activate and deactivate control of the expansion valve according to compressor operation (ON or OFF). If a Slave is in duty setting mode (due to a probe error), the proportional component corresponding to the unit with the error will be equal to the value of parameter c13, weighted according to the cooling capacity (PE2).

6.6 Compressor

The compressor can be selected during the wizard (commissioning). Before selecting the compressor installed on the unit, make sure that the Power+ inverter is connected to the Heos controller. In screen Dab01, select one of the compressors available for the application.

- HIT.ZS1216-7798D1-230V
- TOSHIBA DA91A1F-230V
- TOSHIBA DA130A1F-230V
- TOSHIBA DA220A2F-230V
- TOSHIBA DA330A3F-230V
- TOSHIBA DA420A3F-230V

Other models can be implemented by contacting Carel HQs directly.



The thermodynamic parameters and times are part of the Heos controller software: these are used to control the compressor, making sure that normal operating conditions are always within the limits set by the manufacturer. The electrical parameters are written in the Power+ inverter firmware: these are the parameters that allow the sensorless controller to effectively manage the compressor. Selecting the compressor involves configuring all the thermodynamic parameters and times on the Heos controller; writing the parameters (last item on the screen) initialises the electrical parameters on Power+. Once the model has been selected and the parameters downloaded to Power+, no other compressor parameters are required to start the unit.

Envelope management

The envelope defines the operating range in which the compressor can safely work for an indefinite time. This can be represented graphically by plotting several limits, inside which normal operating conditions need to be kept. The figure shows the envelope for the Toshiba DA series horizontal compressors.

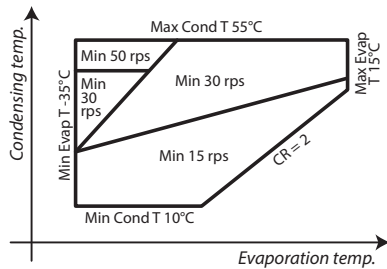

Fig. 6.d

The limits of the envelope consist of:

- Minimum and maximum condensing temperature
- Minimum and maximum evaporation temperature
- Minimum and maximum compression ratio (CR)
- Maximum compressor current draw

Normal operating conditions are defined by:

- Evaporation pressure (or saturated temperature)
- Condensing pressure (or saturated temperature)
- Discharge temperature
- Rotation speed (rps)

The form of the envelope may change according to compressor speed, and with this the normal operating conditions considered as being safe for the compressor. Consequently, a certain pair of operating pressures may be considered safe (within the envelope) at a certain speed, and unsafe (outside the envelope) at another speed.

With reference to the Toshiba envelope shown above: the conditions $T_{cond} = 40^{\circ}\text{C}$ $T_{evap} = -10^{\circ}\text{C}$ are inside the envelope at a speed of 30 rps, but are outside at a speed of 15 rps.

The set point depends on the outside conditions (fluid temperature at the heat exchangers) and on unit operation: compressor speed, expansion valve opening. Consequently, the set point can be shifted, increasing or decreasing the condensing and evaporation pressures by adjusting compressor speed and valve opening.

If operating conditions are near the limit of the envelope or outside of it, the controller will implement corrective actions so as to keep the set point within the limits allowed by the manufacturer. In these cases, therefore, effective compressor speed may not correspond to the cooling capacity required by the temperature controller and superheat may differ from the value set by the user. If operating conditions remain outside of the envelope for a time exceeding the alarm threshold (default 180 s), the compressor will be stopped and an alarm signal will be activated, indicating the zone where operation was outside of the envelope.

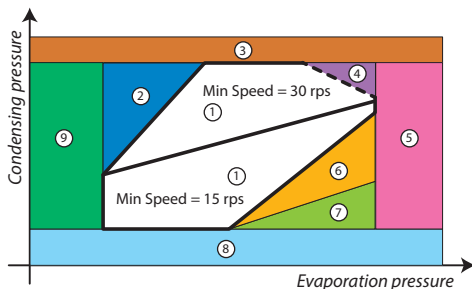

Fig. 6.e

The control actions are (see fig. 6.e):

1. Inside envelope	6. Low compression ratio
2. High compression ratio	7. Low differential pressure
3. High condensing pressure	8. Low condensing pressure
4. High current	9. Low evaporation pressure
5. High evaporation pressure	

Heos also features the following parameters for managing the compressor ON/OFF times

Par.	Description	Def	U.M.	Min	Max
c0	Start control delay at power on	0	min	0	15
c1	Minimum time between successive compressor calls	6	min	0	15
c2	Minimum compressor off time	3	min	0	15
c3	Minimum on compressor time	3	min	0	15

c0 is used to delay the start of control when powering on This is useful in the event of power failures, so that the controllers (in the network) don't all start at the same time, avoiding potential problems of electrical overload.

c1 sets the minimum time between two successive starts of the compressor, irrespective of the request. This parameter can be used to limit the maximum number of starts per hour;

c2 sets the minimum compressor off time. The compressor is not started again until the minimum time set has elapsed;

c3 sets the minimum compressor running time.

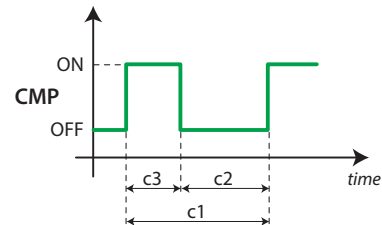

Fig. 6.f

Key:	
CMP	compressor

On/off

The compressor starts whenever the request is equal to the minimum speed in the allowed range. For example, if the compressor has a range from 20 to 80 rps, it will be started when the request is equal to 25%.

The compressor is stopped when the request is equal to 0%.

Start-up procedure

When the compressor starts, a special startup procedure is applied. The compressor speed value depends on the model (c1A) and is kept constant, irrespective of the request from the controller, for a minimum time corresponding to the minimum ON time (c3). Once this time has elapsed, the compressor speed will reflect the temperature control request

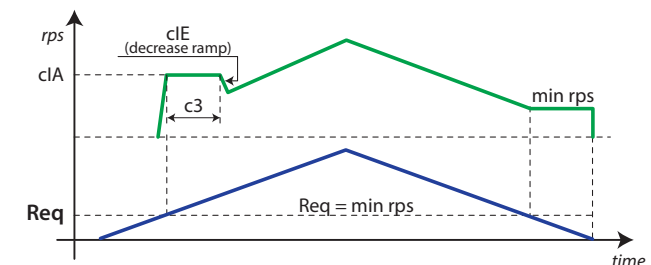

Fig. 6.g

Acceleration/deceleration ramps (screen Dab08)

According to the model of compressor, acceleration, deceleration and stopping ramps are defined. These are expressed in rps/s, and represent the maximum speed variation allowed each second to increase or decrease operating speed or stop the compressor. When the request varies more quickly, the compressor speed will change according to the set ramps.

Par.	Description	Def	U.M.	Min	Max
cId	Maximum speed increase (control)	1.0	rps/s	0.1	Type comp
cIE	Maximum speed decrease (control)	1.0	rps/s	0.1	Type comp
ClF	Maximum speed decrease (shutdown)	1.0	rps/s	0.1	Type comp

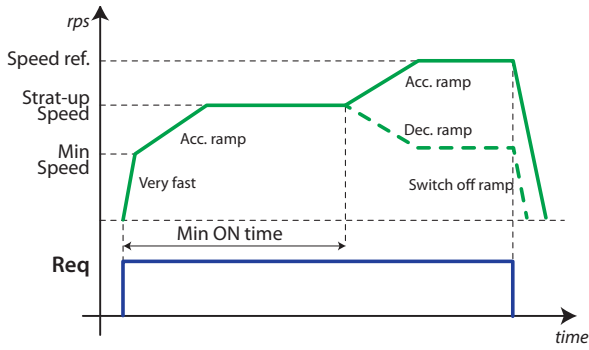

Fig. 6.h

Equalising procedure (screen Daa02, Dab05)

If, when the compressor is requested to start, the difference between discharge pressure and suction pressure is greater than the maximum allowed for start-up (cI5), the equalising procedure (cE1) can be activated:

- using the expansion valve; this procedure involves opening the valve by a set percentage (cE2) and for a set time (cE2);
- using an equalising solenoid valve;
- When the pressure differential is less than (cI5), the expansion valve is positioned at the initial opening set for CP1, while if equalising by solenoid is set, this is closed and the compressor can be started.

Par.	Description	Def	U.M.	Min	Max
cE1	Select equalising procedure mode	0	--	0	1
cE2	Maximum EEV opening time during equalisation	90	s	0	999
cE3	EEV pre-opening percentage during equalisation	60	%	20	99.9

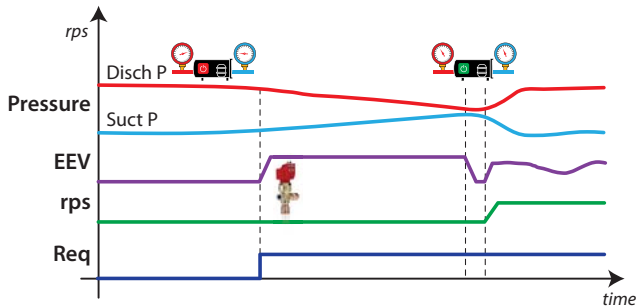

Control increase in ΔP when starting (screen Dab05)

To verify correct compressor rotation and a correct increase in pressure differential, the latter is checked whenever the compressor is started. This involves measuring the increase in ΔP after a set time (cI7). If the increase is less than the settable threshold (cI6), the compressor is stopped and the failed start alarm is signalled.

Par.	Description	Def	U.M.	Min	Max
cI5	Maximum pressure delta for compressor start	0.5 (7.3)	bar/ psi	0.0 (0.0)	120 (1762.8)
cI6	Minimum pressure delta for compressor start	0.2 (2.9)	bar/ psi	0.1 (1.5)	2.0 (29.4)
cI7	Pressure delta control delay to check comp. start-up	10	s	1	99

Start failure management (screen Dab06)

If the compressor fails to start, the controller will make several attempts to start it again.

Par.	Description	Def	U.M.	Min	Max
cI8	Activation delay after failed start	30	s	1	360
cI9	Number of restart attempts after failed start	5	--	0	9

Oil recovery procedure (screen Dab11, 12)

In the event of operation a low speed, with low refrigerant flow-rate and speed, the risk may arise of insufficient oil return to the compressor. One solution to this problem involves a momentary acceleration (at speed cIV) of the compressor for a time cIS whenever operating speed is below a certain threshold (cIt, cIU) for a set time (cIc).

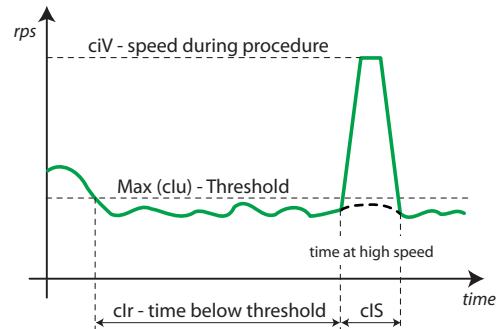

Fig. 6.i

Par.	Description	Def	U.M.	Min	Max
cIP	Enable oil recovery management	1	--	0	1
cIc	Oil recovery procedure activation time	30	min	1	480
cIS	Compressor override time during procedure	2	min	1	10
cIU	Min. comp. output to activate oil recovery procedure	Comp %	%	10.0	99.9
cIV	Comp. speed during oil recovery procedure	100	%	0	100

Oil recovery procedure in multi-evaporator system

If the system is configured as multi-evaporator, the oil recovery procedure will be:

- cIS Compressor override time: multiplied by the number of evaporators.
- The procedure is performed as shown in the figure:

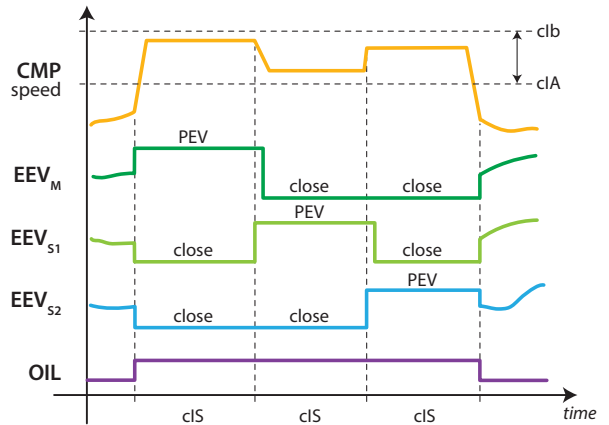

Fig. 6.j

- The total procedure lasts cIS x no. of evap., and is divided into equal sections corresponding to the number of evaporators.
- In each section, the valve on that evaporator is active (PEV), while the others are closed.
- When the valves start normal control again at the end of the procedure, these return to the last position saved at the start.
- The compressor speed varies between StartUp (cIA) and cIb (keeping envelope control active), based on the weight of the evaporator.
- If Treg falls below the set point minus a set delta, the procedure ends, without a delay, for the cabinet/showcase in question.

The changeover from one section to the next occurs as follows:

- showcase 1 ends the procedure;
- the valve on showcase 2 opens;
- the valve on showcase 1 closes after a 5 second delay.

High discharge temperature control (screen Daa03, Daa04, Daa05)

Discharge temperature is an important indicator of the compressor's health: by continuously monitoring this value, a procedure can be implemented to keep the temperature under control.

Envelope control involves actions to adjust compressor speed and expansion valve opening, so as to keep discharge temperature within the allowed limits. In addition, a liquid injection procedure can also be configured:

1. by an ON/OFF liquid injection valve activated when the discharge temperature exceeds a threshold, and deactivated when it returns below the threshold minus a differential.
2. by an electronic valve (connected to connector J8 - see Fig. 2.d); in this case there will be continuous modulation of operation with P+I control set by parameter LII.

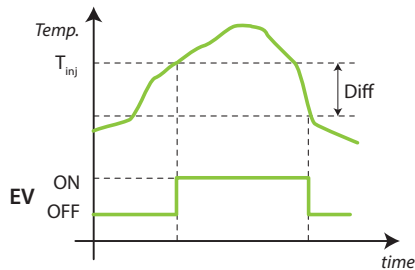

Fig. 6.k

Par.	Description	Def	U.M.	Min	Max
LIV	Type of liquid injection valve	0	--	0	1
LIt	Liquid injection function activation threshold	95.0 (203.0)	°C (°F)	50.0 (122.0)	150.0 (302.0)
LIP	Liquid injection control proportional coefficient	5	--	1	200
LII	Liquid injection control integral time	100	s	1	999
LId	Liquid injection differential	5.0 (9.0)	°C (°F)	0.1 (0.2)	20.0 (36.0)
Llc	Duty Cycle	100	%	0	100
LIS	Duty Cycle period	30	s	0	60

Compression ratio control

When normal operating conditions mean the compressor works at a compression ratio below the limit allowed by the envelope, two procedures can be activated:

- MOP procedure using EEV: the valve closes, increasing the pressure differential and consequently the compression ratio
- compressor acceleration: increasing the speed, the compressor increases the pressure differential and consequently the compression ratio.

Control with ON/OFF compressor

In the branch used to configure the type of compressor, ON/OFF compressors can also be selected; in this case, control is based on temperature too.

The PID remain parameters the same (kp and ti), with the same meaning for both inverter-controlled and on/off compressors.

The compressor is started when the request exceeds 98% and stops when it falls below 2%.

In multi-evaporator configurations, the suction valves close when the compressor is OFF.

Pressure control with ON/OFF compressor

If a multi-evaporator system is configured, control can be performed based on pressure rather than temperature. In this case, the control sequence is as follows:

- the compressor is started (based on pressure) by one of thermostats on the cabinet/showcase, with active envelope control;
- the individual EEV valves strive to maintain the desired controlled temperature inside the cabinet/showcase, as set on screen Ca02.

6.7 Defrost

Scheduling

Screens Dcb01-Dcb04 can be used to set up to 8 defrost events managed by the clock (RTC) on the controller, and activate Power Defrost. The screen for setting the first two events is shown below:

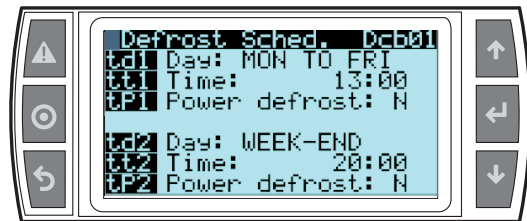

Heos can manage the following types of defrost, depending on the setting of parameter d0: electric heater, hot gas, reverse cycle. The defrost can end based on temperature, in which case the defrost probe Sd needs to be installed, or after a set time. In the first case, the defrost ends when the defrost probe Sd reading exceeds the end defrost value dt1 or the time dP1 has elapsed, while in the second case, only when the time dP1 has elapsed. If end defrost by temperature is selected, an alarm can be activated if the defrost ends when exceeding the maximum time. At the end of the defrost, a dripping stage can be activated (if the dripping time dd is greater than 0), in which the cooling cycle is not active and the fans are off, and then a further post-dripping stage, if the time Fd (screen Dd02) is greater than 0, during which the cooling cycle restarts with the fans off. Parameter d6 (screen Ec02) can be used to select what is displayed on the PLD during the defrost.

Par.	Description	Def	U.M.	Min	Max
d0	Type of defrost/end defrost 0: electric/ temp-timeout 1: reverse cycle/ temp-timeout 2: electric/ timeout only 3: reverse cycle/ timeout only 4: electric/ time with temp. control 5: hot gas bypass/ temp-timeout 6: hot gas bypass/ timeout only	0	--	0	6
dt1	End defrost temperature	8.0 (46.4)	°C (°F)	-50.0 (-58.0)	50.0 (122.0)
dP1	Maximum defrost duration	40	min	1	240
dd	Dripping time after defrost (fans off) 0 = no dripping	120	s	0	600
d9	Disable evaporation pressure alarm in defrost	0	--	0	1
Fd	Fan off time in post-dripping	60	s	0	240

Dripping time after defrost (param. dd)

This parameter is used to stop the compressor and the evaporator fans following a defrost so as to allow the evaporator to drip. The value of the parameter indicates the off time in minutes. If dd=0 no dripping time is enabled, and at the end of the defrost control resumes immediately, without stopping the compressor and the fan, if active.

The standard defrost cycle is illustrated below.

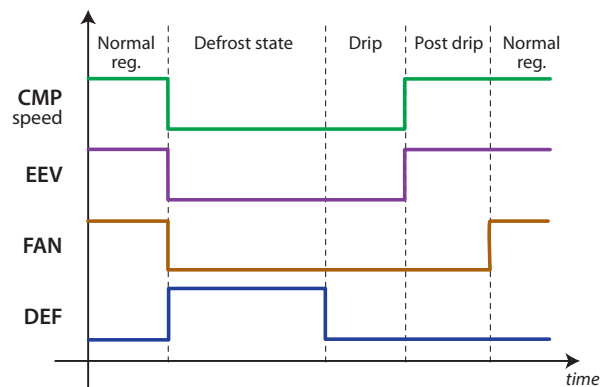

Fig. 6.l

Key			
CMP	Compressor	Drip	Dripping time
EEV	Expansion valve	Post drip	Post-dripping time
FAN	Fan		
DEF	Defrost		

For Master/Slave networks with synchronised end defrost, control resumes on all units when the last of these reaches dt1 or the time dP1 has elapsed. The units in standby remain in the dripping stage: fans off and cooling deactivated (or at minimum capacity without heater defrost).

Heater defrost (d0 = 0, 2, 4):

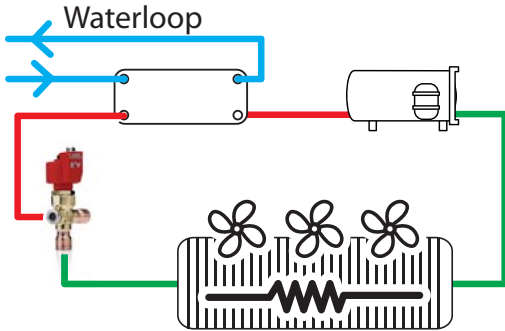

Fig. 6.m

When starting the defrost, the compressor stops, following the stopping ramp. The heaters are activated, the fans switch off and the expansion valve closes. At the end of the defrost, the heaters are deactivated, and the dripping time elapses with the compressor, valve and fans off. This is followed by the post-dripping stage, with the compressor and valve reactivated while the fans remain off. At the end of the post-dripping stage, normal control resumes.

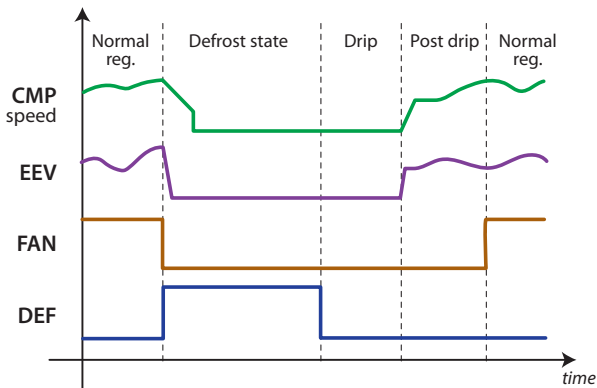

Fig. 6.n

Key			
CMP	Compressor	Drip	Dripping time
EEV	Expansion valve	Post drip	Post-dripping time
FAN	Fan		
DEF	Defrost		

The heater defrost by time with temperature control (d0=4) activates the defrost output only if the evaporator temperature (Sd) is less than the value of parameter dt1, and ends after the time defined by dP1. This function is useful for energy saving.

Hot gas defrost (d0 = 5, 6)

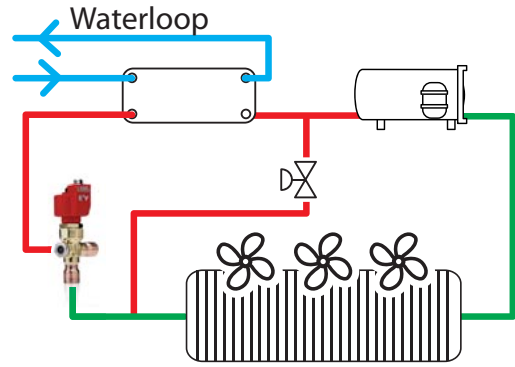

Fig. 6.o

When starting the defrost, the compressor is controlled at the defrost speed (parameter dH2). The bypass valve (HGV) is activated, the fans switch off and the expansion valve operates as normal. At the end of the defrost, the HGV is deactivated, the dripping period elapses with compressor operating at minimum capacity, the expansion valve operating and the fans off. This is followed by the post-dripping stage, with the compressor reactivated and the fans off. At the end of the post-dripping stage, normal control resumes.

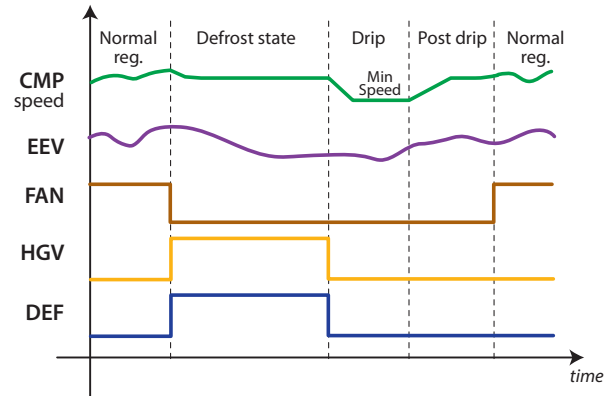

Fig. 6.p

Key			
CMP	Compressor	HGV	Hot gas bypass valve
EEV	Expansion valve	Drip	Dripping time
FAN	Fan	Post drip	Post-dripping time
DEF	Defrost		

Defrost by reversing the cycle (d0 = 1, 3)

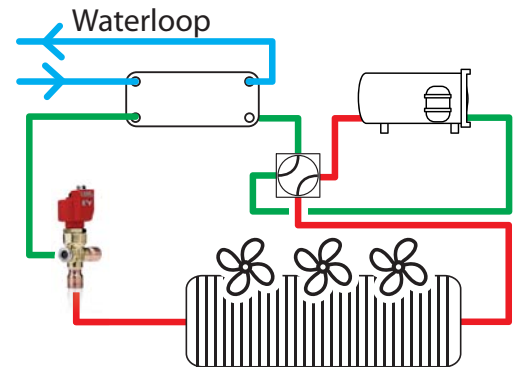

Fig. 6.q

When starting the defrost, the compressor decelerates to minimum speed, and after a delay (dG5) the 4-way valve is activated. After 5 seconds, the compressor accelerates to the defrost speed dG2, until the defrost ends. After the time dG6 elapses, the 4-way valve is deactivated and control resumes after a delay (dG7). During the defrost, the expansion valve can be set to operate as normal or remain in a stable, set position (parameters dG8, dG9, dG10)

Par.	Description	Def	U.M.	Min	Max
dG2	Compressor speed (defrost by reversing the cycle)	50.0	rps	clc	clb
dG3	Maximum acceleration in defrost (reverse cycle)	1.0	rps	clid	clE
dG4	Out of envelope alarm delay (defrost by reversing cycle)	600	s	0	999
dG5	4-way valve changeover delay on defrost	10	s	0	99
dG6	4-way valve changeover delay after defrost	10	s	0	99
dG7	End defrost delay (defrost by reversing cycle)	60	s	0	180
dG8	EEV mode at start defrost	1	--	0	1
dG9	EEV mode during defrost	1	--	0	1
dG10	EEV mode at end defrost	1	--	0	1

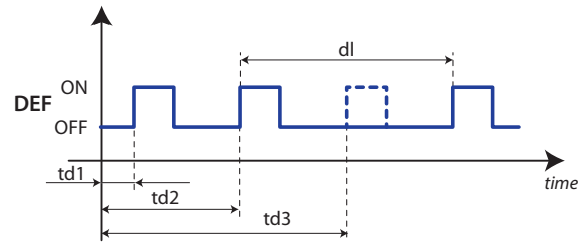

Fig. 6.s

Key		DEF	Defrost
dl	Maximum time between consecutive defrosts		
td1...td3	Scheduled defrosts		

Pump Down

With a heater defrost, the pump down cycle is always performed, in which the evaporator is emptied of liquid refrigerant immediately before the defrost starts. When starting the defrost, the expansion valve is immediately closed, and the compressor stops with a deceleration ramp lasting a few seconds. In this stage, the refrigerant is pumped to the high pressure section of the unit.

Other defrost management parameters concern the activation delays, synchronisation between Master and Slave, defrost stages such as pump down and dripping, and advanced functions, including

- Running time;
- Sequential stops;
- Skip defrost;
- Power defrost.

End defrost synchronised by Master (parameter d2)

This parameter determines whether or not, in a local network, at the end of the defrost Heos waits for an end defrost signal from the Master before restarting the cooling cycle.

Par.	Description	Def	U.M.	Min	Max
d2	End defrost synchronised by Master 0 = local only; 1 = start; 2 = start and end.	1	--	0	2

In the event of synchronised end defrosts (d2=2), after the post-dripping time (if set), control resumes when the last unit has ended defrosting. The units that end the defrost before the last wait in the dripping stage (see the following figure).

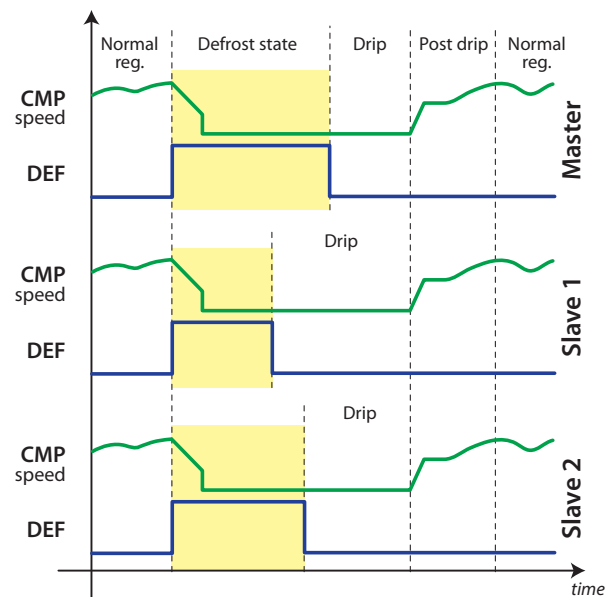

Fig. 6.t

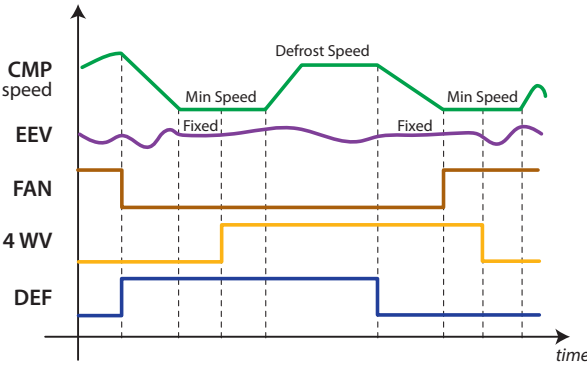

Fig. 6.r

Key	
CMP	Compressor
EEV	Expansion valve
FAN	Fan
DEF	Defrost
4WW	Reversing valve

Maximum time between consecutive defrosts (parameter dl)

Parameter dl (screen Dca03) is a safety parameter used to perform cyclical defrosts every "dl" hours, even without the Real Time Clock (RTC). It is also useful if the pLAN or RS485 serial network is disconnected, when defrosts are controlled by the supervisor. At the start of each defrost, irrespective of the duration, an interval starts being counted. If this interval exceeds dl without a defrost being performed, one is started automatically. The count is always active even if the controller is OFF. If set on Master controller, the parameter has effect on all the sub-LANs connected, if set on a Slave controller, it only has an effect locally.

Par.	Description	Def	U.M.	Min	Max
dl	Interval between two consecutive defrosts 0=disabled	8	h	0	500
d4	Enable defrost at start-up 0: disabled (NO); 1: enabled (YES)	0	--	0	1
d5	Defrost delay at start-up or from digital input	0	min	0	240

Defrost at start-up (parameter d4)

Defrost at start-up has priority over the control request. On the Master controller the defrost at start-up will be a network defrost, while on the Slave controllers it will be local.

Defrost delay at start-up (parameter d5)

Also active when d4=0. If the digital input is set to enable or start a defrost via an external contact, parameter d5 represents the delay between enabling or calling the defrost and when it effectively starts. In a Master/Slave network, to activate the heater defrost via a digital input on the Master, it is suggested to use parameter d5 to delay the various defrosts on the Slaves, thus avoiding current overloads.

Example: if due to an RTC fault, the scheduled defrost (td3) is not performed, after the safety time dl, a new defrost starts.

Defrost ended by timeout signal (parameter r3)

For defrosts that end at a set temperature, this enables an alarm to signal the end of the defrost by timeout.

Par.	Description	Def	U.M.	Min	Max
r3	Enable end defrost signal for maximum time 0: disabled (NO); 1: enabled (YES)	0	--	0	1

Running time defrost (parameters d10, d11, dA1)

Running time is a special function that determines when the refrigeration unit needs defrosting. In particular, it is assumed that if the evaporator temperature measured by probe Sd remains continuously below a certain set threshold (d11) for a certain time (d10), the evaporator may be frozen and a defrost is activated. The time is reset if the temperature returns above the threshold. The probe used is set by parameter dA1. In addition, at start-up the time dA2 must elapse before the running time procedure is activated.

Par.	Description	Def	U.M.	Min	Max
d11	Defrost time in Running Time mode 0 = function disabled	-4.0 (24.8)	°C (°F)	-50.0 (-58.0)	30.0 (86.0)
d10	Defrost Running Time temperature threshold	0	min	0	240
dt1	End defrost temperature (read by Sd)	8.0 (46.4)	°C (°F)	-50.0 (-58.0)	50.0 (122.0)
dA1	Select probe for activation (Sd or Tsat)	0	--	0	1
dA2	Delay at start-up before activating Running Time	30	min	0	480

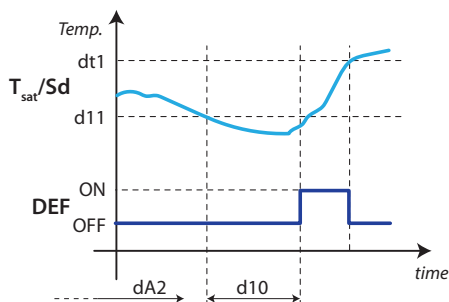

Fig. 6.u

Key		
Sd	Defrost probe	DEF Defrost
Tsat	Saturation temperature converted from suction pressure	

Running time defrost in a Master/Slave system

The defrost is activated, based on the selected probe reading, on the individual unit, independently of the others; if the Master starts a defrost in running time mode, this will be a network defrost, otherwise it will be local.

Sequential stops (parameters dS1, dS2)

Par.	Description	Def	U.M.	Min	Max
dS0	Enable defrost by Sequential Stops	0	--	0	1
dS1	Compressor operating time for Sequential Stops defrost	180	min	0	999
dS2	Compressor off time for Sequential Stops defrost"	10	min	0	999

Sequential stop mode is especially useful for high-normal temperature refrigeration units, and is based on intelligently stopping control to allow the evaporator to defrost naturally by the flow of ambient air only, without activating the defrost output.

If the function is enabled (parameter dS0), during normal control two countdown timers are started:

- **OFFTIME**: counts down when control has stopped and paused during control;
- **ONTIME**: counts down during control and paused when control has stopped.

Two events may occur, with reference to the following figure:

- **OFFTIME** reaches zero (instant C): OFFTIME and ONTIME are reset with the values of dS1 and dS2 and the defrost is considered as having already been completed. Control resumes;
- **ONTIME** reaches zero (instant A): OFFTIME is reset with the value of dS1 and the natural defrost cycle starts, which lasts for the time dS1. At the end of the defrost (instant B), OFFTIME and ONTIME are reset with the values of dS1 and dS2 and control resumes.

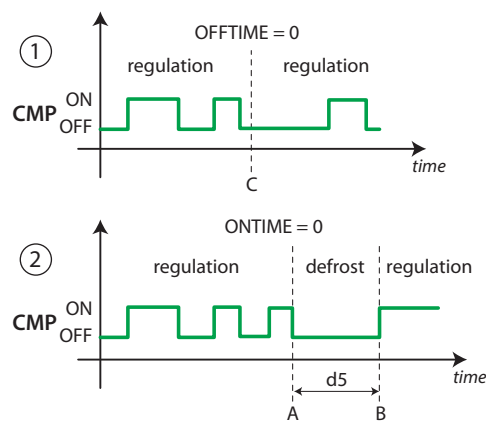

Fig. 6.v

Key	
CMP	Compressor

The purpose is to stop control and allow natural defrosts only when necessary.

Skip defrost (parameters d7, dn, do)

The function applies to defrosts that end by temperature, otherwise it has no effect. The Skip defrost function evaluates whether the defrost duration is less than a certain threshold (dn) and based on this establishes whether or not the subsequent defrosts will be skipped.

Par.	Description	Def	U.M.	Min	Max
d7	Enable skip defrost 0: disabled (NO); 1: enabled (YES)	0	--	0	1
dn	Nominal defrost duration for skip defrost	45	min	0	240
do	Number of defrosts to be performed when starting before activating skip def.	7	--	1	9

The algorithm keeps a counter of the defrosts to be skipped:

- if the defrost ends in a time less than dn1, the counter of the defrosts to be skipped is increased by 1;
- if the defrost ends normally, the next defrost is performed;
- when the counter reaches 3, three defrosts are skipped;
- at start-up, the defrost is performed "do" two times without increasing the counter.

Power defrost (parameters ddt, ddP)

Power defrost is used to increase the end defrost threshold dt1 and/or the maximum defrost duration dP1. These increases allow longer and more effective defrosts. Power defrosts are performed on each defrost call during night-time status or when suitably configured by the RTC parameters (sub-parameter P of parameters td1 to td8), so as to allow the user to choose the conditions that are most suitable for this special procedure. Power Defrost is activated when at least one of the increases, ddt or ddP, has any value other than zero.

Par.	Description	Def	U.M.	Min	Max
ddt	Additional defrost temperature delta in Power Defrost mode	0.0 (0.0)	°C (°F)	-20.0 (-36.0)	20.0 (36.0)
ddP	Additional maximum defrost time delta in Power Defrost mode	0	min	0	60

Note: in Power Defrost mode, the maximum defrost duration dP1 is increased by the value of parameter ddP.

6.8 Evaporator fans

The evaporator fans can be set to operate always, or be managed according to the temperature measured by the defrost and control probes. Fan behaviour is set by par. F0:

Note: during the dripping time and post-dripping time, if set, the evaporator fans are always OFF.

Fixed speed fans

Below are the parameters involved in managing fixed speed fans, related by default to relay 6, and an example of the trend based on the difference between the evaporator temperature and the value of the virtual probe (F0=1). If F0=2, activation depends solely on the evaporator probe temperature.

Par.	Description	Def	U.M.	Min	Max
F0	Fan management configuration	0	--	0	2
F1	Fan activation threshold	-5.0 (23.0)	°C (°F)	-50.0 (-58.0)	50.0 (122.0)
F2	Enable fans off with controller off (OFF); 0: see F0; 1: always off	0	--	0	1
F3	Enable fans off during defrost 0: fans always ON 1: fans always OFF 2: fans ON, OFF in dd	0	--	0	2
Fd	Fan Off time in post-dripping 0: no dripping	60	s	0	240
Frd	Fan differential	2.0 (3.6)	°C (°F)	0.1 (0.2)	20.0 (36.0)
dd	Dripping time after defrost (fans off)	120	s	0	600

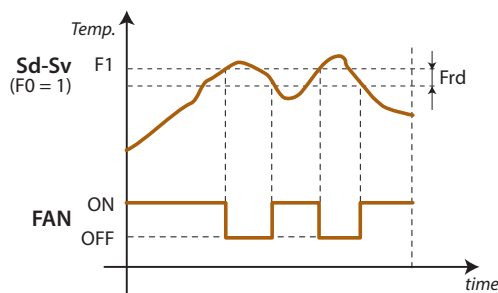

Fig. 6.w

Key			
Sd	Evaporator probe	Frd	Control differential
Sv	Virtual probe	FAN	Evaporator fans
F1	Fan activation speed setting		

The fans can be turned off in the following situations:

- when the compressor is off (parameter F2);
- during defrost (parameter F3).

During the dripping period (parameter dd > 0) and the post-dripping period (parameter Fd > 0) the evaporator fans are always off. This is useful to allow the evaporator to return to temperature after defrosting, thus avoiding blowing warm hot and moist air into the refrigerated environment.

Variable speed fans

The installation of variable speed fans may be useful in optimising energy consumption. In this case, the fans are powered by the mains, while the control signal may come from a PWM or 0-10 V output. The maximum and minimum fan speed can be set using parameters F6 and F7. Frd in this case represents the variation in temperature for switching fan speed from minimum to maximum. If using the fan speed controller, F5 represents the temperature below which the fans are activated. There is a fixed hysteresis of 1°C for deactivation.

Par.	Description	Def	U.M.	Min	Max
F5	Evaporator fan cut-off temperature (hysteresis 1°C)	0.0 (32.0)	°C (°F)	-50.0 (-58.0)	50.0 (122.0)
F6	Maximum fan speed	80	%	min	100
F7	Minimum fan speed	10	%	0	max
F8	Fan peak time 0: function disabled (NO);	10	s	0	240
F9	Override fan output to 100% every: 0: function disabled (NO);	0	min	0	240

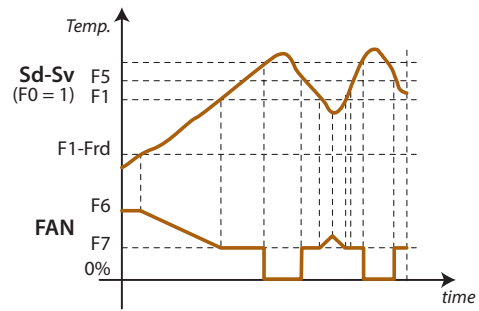

Fig. 6.x

Key

Sd	Evaporator probe	F1	Evaporator fan activation threshold
Sv	Virtual probe	Frd	Fan activation differential
F5	Fan cut-off temperature		

F6 is the maximum fan speed, expressed as a % of the output. For 0 to 10 V outputs, it represents the output voltage at maximum speed as a percentage. The same is true for the minimum speed set for F7. The fan peak time F8 represents the operating time at maximum speed set using parameter F6 to overcome the mechanical inertia of the motor. F9 represents the time the fan is operated at maximum speed for the peak time (F8). If the fan is kept operating too long at low speed, ice may form on the blades; to avoid this, every F9 minutes the fan is operated at maximum speed for the time set for parameter F8.

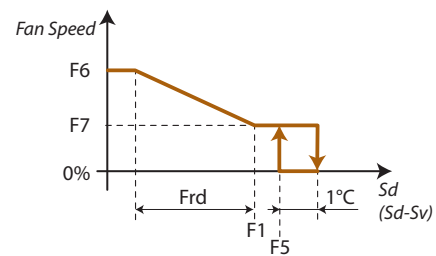

Fig. 6.y

6.9 Electronic valve

Heos can manage Carel E2V single-pole valves (with 6-wire cable). Double-pole valves (with 4-wire cable) are incompatible with Heos. To manage the electronic expansion valve, two additional probes must be installed and suitably configured: temperature probe for measuring the superheated gas temperature at the evaporator outlet; pressure probe for measuring the saturated evaporation pressure/temperature at the evaporator outlet

Installation notes:

Heos is designed to manage one electronic expansion valve that controls the flow of refrigerant inside an individual evaporator. Two evaporators in parallel cannot be managed with just one electronic expansion valve. The NTC/PTC/PT1000 temperature probe must be installed near the evaporator outlet, according to the standard installation methods (see the installation notes on the E2V instruction sheet). Suitable thermal insulation is recommended. CAREL offers special types of probes designed to simplify installation in contact with the refrigerant pipe:

- NTC030HF01 for Retail use IP67, 3m, -50T90 °C, 10 pcs
- NTC060HF01 for Retail use IP67, 6m, -50T90 °C, 10 pcs

To measure the saturated evaporation temperature, different types of probes can be used; in particular, the following can be installed:
 0 to 5 V ratiometric pressure probe (recommended by CAREL);
 4 to 20 mA active pressure probes .
 Conversion of the pressure to a temperature value is performed automatically once the refrigerant has been selected (see the paragraph on the compressor)

Overview screen (screen Dbd01)

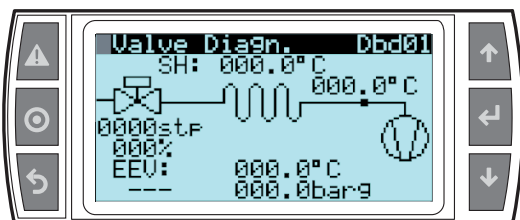

Heos manages the proportional opening of the electronic expansion valve, adjusting the flow of refrigerant in the evaporator, so as to maintain the superheat around the value set for advanced parameter P3 (superheat set point). The opening of the valve is controlled simultaneously yet independently from normal temperature control. When there is a refrigeration call (the compressor is operating), control of the electronic valve is also activated and then managed independently of compressor speed. If the superheat value read by the probes is greater than the set point, the valve is opened proportionally to the difference between the values. The speed of variation and the percentage of opening depend on the PID parameters set. The opening is continuously modulated based on the superheat value, with PID control.

Superheat set point (parameter P3)

This is used to set the reference superheat value for the control of the electronic valve. It does not determine the actual superheat value, but rather the desired value. Heos, with PID control, tends to maintain the actual superheat, calculated based on the probe readings, around the value set for this parameter. This is done by gradually varying the opening of the valve based on the difference between the actual superheat and the set point.

Par.	Description	Def	U.M.	Min	Max
P3	Setpoint superheat	10.0 (36.0)	°C (°F)	0.0 (0.0)	30.0 (54.0)

! Important: the set point value calculated depends on the quality of the installation, the position of the probes and other factors. Consequently, depending on the installation, the set point read may deviate from the actual value. Set point values that are too low (2...4 K), albeit ideally usable, may cause problems involving the return of liquid refrigerant to the compressor.

Valve position at start control (parameter cP1)

This is used to set the position of the valve as a percentage when control starts. High values ensure intense and immediate cooling of the evaporator when each call is sent, however may cause problems if the valve is oversized with reference to the cooling capacity of the controller. Low values, on the other hand, allow a more gradual and slower action. The values set should be coherent with compressor start-up speed.

Par.	Description	Def	U.M.	Min	Max
Psb	Enable EEV opening in standby	0	--	0	1
CP1	EEV opening at start-up	50	%	0	100
cP2	EEV pre-positioning delay	6	s	0	300.0

PID control of the expansion valve (parameters P4, P5, P6)

The opening of the electronic valve is controlled based on the difference between the superheat set point and the actual superheat calculated by the probes. The speed of variation, the reactivity and the ability to reach the set point depend on three parameters:

- Kp = proportional gain, parameter P4;
- Ti = integral time, parameter P5;
- Td = derivative time, parameter P6;

The ideal values to be set vary depending on the applications and the utilities managed, nonetheless default values are proposed that allow good control in the majority of cases. For further details, refer to classic PID control theory.

Par.	Description	Def	U.M.	Min	Max
P4	PID: EEV proportional gain	15.0		0.0	100.0
P5	PID: EEV integral time 0 = function disabled (NO);	150	s	0	999
P6	PID: EEV derivative time 0 = function disabled (NO);	5.0	s	0.0	100.0

P4: this represents the amplification factor. It determines an action that is directly proportional to the difference between the set point and the actual superheat value. It acts on the speed of the valve, in terms of steps/°K. The valve moves P4 steps for every degree variation in the superheat, opening or closing whenever the superheat increases or decreases respectively. It also acts on the other control factors, and is valid in both normal control and with all emergency control functionsa.

- High values ==> fast and reactive valve
- Low values ==> slow and less reactive valve.

P5: this represents the time required by the controller to balance the difference between the set point and the actual superheat. It practically limits the number of steps that the valve completes each second. It is only valid during normal control, the special functions in fact have their own integral time.

- High values ==> slow and less reactive valve
- Low values ==> fast and reactive valve
- P5 = 0 ==> integral action disabled

P6: this represents the reaction of the valve to variations in the superheat. It amplifies or reduces variations in the superheat value.

- High values ==> rapid variations
- Low values ==> limited variations
- P6 = 0 ==> differential action disabled

6.10 Protection functions

LowSH Low superheat

To prevent too low superheat values that may cause the return of liquid to the compressor or system instability (swings), a low superheat threshold can be defined, below which a special protection function is activated. When the superheat falls below the threshold, the system immediately enters low superheat status and activates a control action, in addition to normal control, with the aim of closing the electronic valve more quickly. In practice, the intensity of system "reaction" is increased. If the device remains in low superheat status for a certain period, a low superheat alarm is activated, with the display showing the message 'LSH'. The low superheat signal features automatic reset, when the condition is no longer present or the controller is switched off (standby).

Par.	Description	Def	U.M.	Min	Max
P7	LowSH: low superheat threshold	2.0 (35.6)	°C (°F)	0.0 (32.0)	30.0 (86.0)
P8	LowSH: EEV low superheat integral time 0 = function disabled (NO);	10	s	0.0	999
P9	LowSH: EEV low superheat alarm delay 0 = function disabled (NO);	120	s	0	300.0

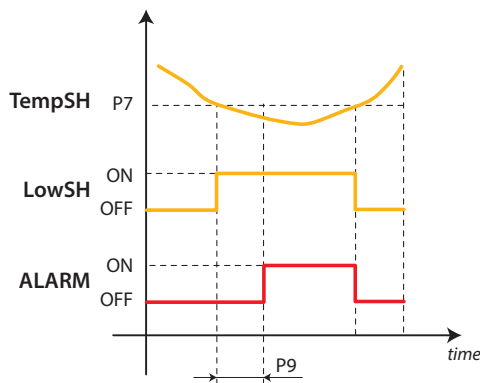

Fig. 6.z

Key			
SH	Superheat	P7	Low SH protection threshold
LowSH	Low superheat protection	P9	Alarm delay
ALARM	Alarm		

MOP Maximum evaporation pressure

When starting or restarting a system, the compressors may not be able to satisfy cooling demand. This may cause an excessive increase in the evaporation pressure and consequently the corresponding saturated temperature. When the evaporation pressure, expressed in degrees (saturated), rises above the threshold, after a certain settable time the system enters MOP protection status: PID superheat control is stopped and the controller starts gradually closing the valve with an integration action to return the evaporation pressure below the threshold. The protection function has been designed to allow a gradual return to normal operating conditions, that is, when the critical conditions have ended, the controller temporarily operates with a higher superheat set point until the function is automatically reset.

Par.	Description	Def	U.M.	Min	Max
PM1	MOP	15.0 (59.0)	°C (°F)	LOP	30.0 (86.0)
PM2	MOP: High evaporation temperature integral time	20.0	s	0.0	999
PM3	MOP: High evaporation temperature alarm delay	240	s	0	300.0

0 = function disabled (NO);

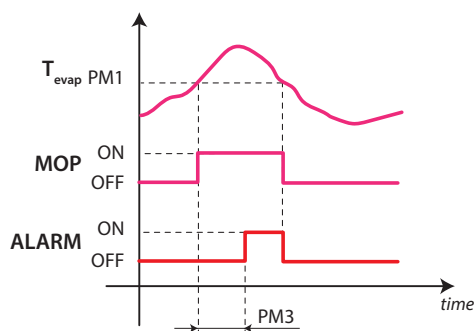

Fig. 6.aa

Key			
T_EVAP	Evaporation temperature	PM1	MOP threshold
MOP	MOP protection	PM3	Alarm delay
ALARM	Alarm		

PM1 represents the maximum evaporation pressure, expressed in degrees (saturated), above which the MOP protection and alarm are activated (each with its own delay times). There is a gradual return to normal operation, to avoid the critical situations arising again.

PM2 represents the integration time for the maximum evaporation pressure protection function. This replaces normal PID control during MOP status.

- PM2 = 0 ==> MOP protection and alarm disabled

PM3 represents the alarm activation delay after exceeding the MOP threshold. When the alarm is activated, the following occur:
 Message 'MOP' shown on the display
 The buzzer is activated
 The alarm features automatic reset when the evaporation pressure falls below the threshold PM1.

LSA - Low suction temperature

When the suction temperature falls below the threshold, the alarm is activated after the set delay, closing the electronic valve. The alarm is reset when the suction temperature exceeds the set threshold plus the hysteresis. Reset is automatic for a maximum of four times in a two hour period. Upon the fifth activation in such period, the alarm is saved and requires manual reset from the user terminal or supervisor.

Par.	Description	Def	U.M.	Min	Max
P11	LSA: low suction temperature threshold	-40.0 (-40.0)	°C (°F)	-50.0 (-58.0)	30.0 (86.0)
P12	Low suction temperature alarm delay	120	s	0	300

0: alarm disabled (NO);

P11 represents the suction temperature below which the alarm is activated, after the corresponding delay. The threshold for resetting the alarm is represented by this threshold plus a 3°C hysteresis.

P12 represents the alarm activation delay after exceeding the threshold P11. When the alarm is activated, the following occur:

- message 'LSA' shown on the display;
- the buzzer is activated

The alarm features automatic reset for the first four activations over a two hour period, then becomes manual reset.

- P12 = 0 ==> LSA alarm disabled

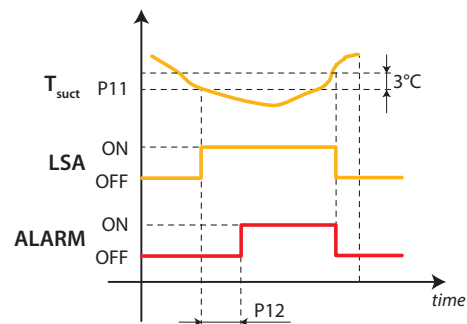

Fig. 6.ab

Key			
T_SUUCT	Suction temperature	LSA	LSA protection
P11	LSA: low suction temperature threshold	ALARM	Alarm
P12	LSA: LSA alarm delay		

LOP Minimum evaporation pressure

This function is used to prevent the evaporation pressure from remaining excessively low for too long. When the evaporation pressure, expressed in degrees (saturated), falls below the threshold, the LOP protection is activated, which adds an integration action to normal PID control, specifically devised to be more reactive as regards the opening of the valve. PID control remains active, as the superheat must continue to be monitored as to avoid flooding the compressor. The LOP alarm is delayed from the activation of the protection function, both are reset automatically when the pressure value, in degrees (saturated), exceeds the threshold.

Par.	Description	Def	U.M.	Min	Max
PL1	LOP	-40.0 (-40.0)	°C (°F)	-50.0 (-58.0)	MOP
PL2	LOP: Low evaporation temperature integral time	10	s	0.0	999
PL3	LOP: Low evaporation temperature alarm delay	120	s	0	300.0

PL1 represents the evaporation pressure, expressed in degrees (saturated), below which the LOP protection is activated. The protection is deactivated immediately when the pressure exceeds this threshold.

PL2 represents the integral constant used during the activation of the LOP protection. This integral time is summed to normal PID control.

- PL2 = 0 ==> LOP protection and alarm disabled

PL3 represents the alarm activation delay after exceeding the LOP threshold. When the alarm is activated, the following occur:
message 'LOP' shown on the display;
the buzzer is activated.

The alarm features automatic reset when the evaporation pressure rises above the threshold PL1.

PL3 = 0 ==> LOP alarm disabled

High superheat

To avoid excessively high superheat values, an alarm threshold and activation delay can be set.

When superheat exceeds the threshold, the system immediately enters high superheat status and activates a function that closes the electronic valve more quickly. If the device remains in high superheat status for a certain period, an alarm is activated, with the display showing the message 'HSh'. The high superheat signal features automatic reset, when the condition is no longer present or the controller is switched off (standby).

Par.	Description	Def	U.M.	Min	Max
Pa	High superheat threshold	35.0 (95.0)	°C (°F)	0.0 (32.0)	50.0 (122.0)
Pb	High superheat alarm delay	600	s	0	999

Manual valve positioning (screen Bb05)

PMP is used to enable/disable manual valve positioning.

PMP = 0: manual positioning disabled;

PMP = 1: manual positioning enabled.

If manual positioning is enabled, PMu is used to set the manual opening of the electronic valve. The value is expressed in steps.

Par.	Description	Def	U.M.	Min	Max
PMP	Enable manual expansion valve positioning 0 = disabled (NO); 1 = enabled (YES)	0	--	0	1
PMu	Manual expansion valve position	0	steps	0	480

6.11 Anti-sweat heater or fan modulation

Anti-sweat heaters are controlled by comparing dew point calculated based on the room temperature and humidity, and the temperature of the showcase glass, measured by a probe or estimated using the showcase outlet, intake and room temperature. Two types of anti-sweat heater control are available:

- PI (proportional, integral);
- fixed activation (manual control).

The conditions for activation of the algorithms are as follows:

Algorithm	Activation condition
PI	rHd > 0
fixed activation (manual control)	rHd = 0; rHt > 0

If the temperature read by the glass temperature probe is only estimated, PI control becomes proportional only. If both algorithms are activated, the PI algorithm has priority over fixed activation, which does not require the room temperature and humidity probes. There are a series of conditions whereby the PI algorithm stops operating and, if activated, fixed activation control takes over.

Condition	Cause
Glass temperature probe not valid	physical probe not configured or error; the estimate of the glass temperature probe cannot be used because the outlet probe or intake probe is not configured or has an error or the room probe is broken or missing (*)
Dew point not valid	room humidity and/or temperature probe are not configured and operating; the serial dew point value is not available .

(*) If the intake probe is not configured or has an error, the outlet probe alone is used.

PI control

Inputs

The room humidity (SU) and temperature (SA) probes can be (see parameters /FL, /FI):

- connected to the Master, which automatically shares them with the Slaves;
- connected locally to each controller;
- sent from the supervisor via the serial probes.

Alternatively, the supervisor can directly supply the dew point value (Sdp) using the serial probes. The glass temperature probe (Svt) can be connected directly to each controller (see parameter /FM), or estimated. The estimate of the glass temperature probe reading is performed internally when: room temperature (SA), outlet temperature (Sm) and intake temperature (Sr) are available, and depends on parameters Ga, Gb and Gc. Parameters rHo, rHd determine the modulating output.

Par.	Description	Def	U.M.	Min	Max
Ga	Coefficient a" for glass temperature formula	2.0 (35.6)	°C (°F)	-20.0 (-4.0)	20.0 (68.0)
Gb	Coefficient b" for glass temperature formula	22	%	0	100
Gc	Coefficient c" for glass temperature formula	80	%	0	100
rHo	Anti-sweat modulation offset from dew point	2.0 (3.6)	°C (°F)	-20.0 (-36.0)	20.0 (36.0)
rHd	Anti-sweat heater differential modulation	0.0 (0.0)	°C (°F)	0.0 (0.0)	20.0 (36.0)

$$Svt = (SA - Ga - 3) - \frac{Gb \cdot (SA - Ga - Ti)}{100}$$

dove:

$$Ti = \frac{Sm \cdot Gc + Sr \cdot (100 - Gc)}{100}$$

If one of the probes is not available (SA or either Sm or Sr), only fixed activation control will be possible, based on parameters rHu and rHt.

Outputs

The analogue output for the anti-sweat function can be 0-10 VDC or PWM. If selecting the PWM output (rHL = 1), this can be associated with an analogue output Y1, Y2, Y3, or the SSR output (OUT2). The output will be active (10 V) for a time that is proportional to the function's activation percentage, with a fixed 24 second period. Selecting the SSR output on the other hand, the relay activation period will be equal to parameter rHt (manual anti-sweat activation time).

If a digital output is selected, it is recommended to set rHt to a value of at least 10 minutes, so as to reduce the number of relay switching cycles. If selecting rHL = 0, the output will be 0-10 Vdc (Y1, Y2, Y3) and can be used to directly drive an FCS controller, for example.

The activation percentage (OUT) for anti-sweat heater control depends on the difference between the dew point calculated and the value read by the glass temperature probe (measured or estimated), the value of parameter rHo (offset) and the value of parameter rHd (differential), as shown in the following figure. The Cutoff is rHB parameter and hysteresis is rHC.

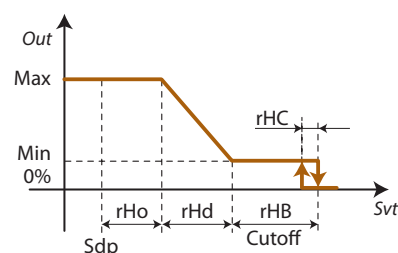

Fig. 6.ac

Key			
Sdp	Dew point	Svt	Glass temperature probe
rHo	Anti-sweat heater modulation offset	Min	Minimum fan speed
rHd	Anti-sweat heater modulation differential	Max	Maximum fan speed
OUT	Anti-sweat controller		

Min: minimum output fixed at 10%; Max: maximum output fixed at 100%. The action is only proportional if the estimate of the glass temperature is used, and proportional and integral (Tint=240 s, constant) if the actual glass temperature probe is used. The aim of the integral action is to bring the glass temperature towards the set point (Sdp+rHo).

Fixed activation control (manual control)

Control depends only on parameters rHu and rHt and follows the trend shown in the figures.

Par.	Description	Def	U.M.	Min	Max
rHt	Anti-sweat heater activation period	30	min	10	180
rHu	Manual activation anti-sweat heaters percentage 0: disabled (NO);	70	%	0	100

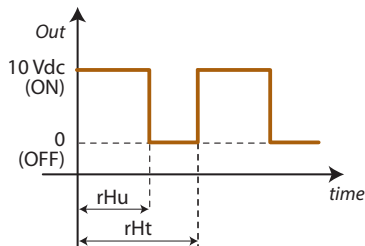

Fig. 6.ad

Key:

rHu	Manual anti-sweat activation percentage
rHt	Manual anti-sweat activation time
OUT	Anti-sweat controller

6.12 Condenser control

Heos can also optimise the condenser control (generally water-cooled) to improve system efficiency. Control is normally performed based on the condensing pressure/temperature, however can also use the water temperature; there are two main types of valves, two-way or three-way mixing valves.

In certain special cases (for example, when ambient heat can be recovered from), air-cooled condensers can also be used; in this case, control is performed based on the condensing pressure/temperature. Consequently, two types of condenser can be chosen on screen Daa06 (displayed only if both analogue outputs have been activated):

- Water-cooled
- Air-cooled

Water-cooled condenser

Below is the water connection diagram with two-way valve. In this case, the flow-rate is modulated so as to stabilise the condensing temperature.

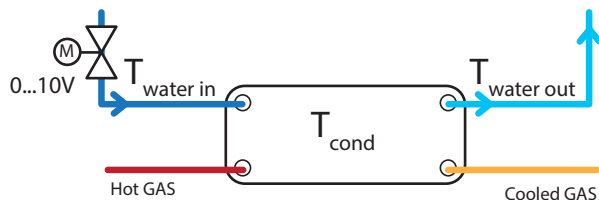

Fig. 6.ae

Note: a variable flow-rate pump must be used in the water loop so as to respond to the variations required by the various cabinets/showcases.

Below is the control diagram based on condensing temperature; the same also applies when using the differential between water inlet and outlet temperature.

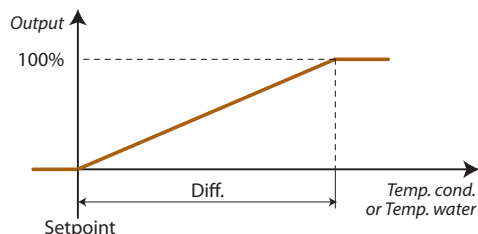
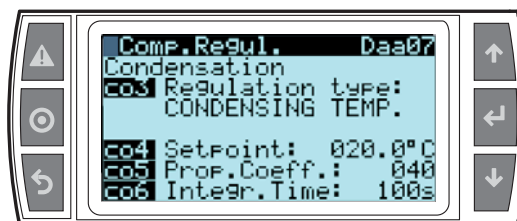

Fig. 6.af

Screen Daa07 is used to select the type of control (condensing temperature or water inlet/outlet temperature or differential), the corresponding set point, differential and integral time. If control is selected based on water temperature, screen Daa09 is displayed for setting a maximum safety threshold for the condensing temperature/ pressure.



Par.	Description	Def	UoM	Min	Max
co3	Type of water-cooled condenser control 0: COND.TEMP. 1: W OUT-IN TEMP. 2: W OUT TEMP. 3: W IN TEMP.	0		0	3
co4	Condensing temp. set point	20.0 (68.0)	°C (°F)	10.0 (50.0)	55.0 (131.0)
	Condenser water temp. diff. set point	5.0 (9.0)	°C (°F)	0.1 (0.18)	20.0 (36.0)
co5	Cond. control proportional coefficient	40	%/°C	1	999
co6	Cond. control integral time	100	s	0	999
coA	Cond. control safety set point	42.0 (107.6)	°C (°F)	30.0 (86.0)	55.0 (131.0)
cob	Cond. control safety differential	5.0 (9.0)	°C (°F)	0.0 (0.0)	9.9 (17.8)

Air-cooled condenser

Below is the air-cooled condenser connection diagram. In this case, air flow-rate is modulated by controlling the fan (0-10 Vdc or by digital output, set in the I/O configuration menu) so as to stabilise the condensing temperature.

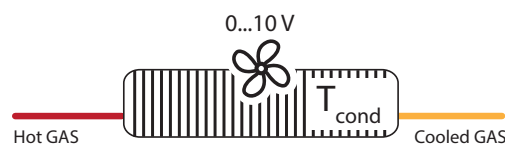

Fig. 6.ag

Below is the control diagram based on condensing temperature/ pressure.

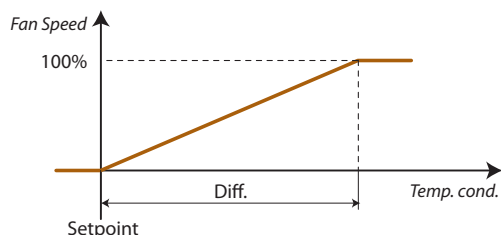

Fig. 6.ah

Par.	Description	Def	UoM	Min	Max
co4	Condensing temp. set point	20.0 (68.0)	°C (°F)	10.0 (50.0)	55.0 (131.0)
co5	Cond. control proportional coefficient	40	%/°C	1	999
co6	Cond. control integral time	100	s	0	999

6.13 Anti-sweat on inverter with cold plate

If the inverter is water-cooled, condensation may form when the water temperature is lower than the dew point in the environment where the inverter is installed. This may potentially occur on low temperature units, when the cooling water is normally lower than room temperature.

There are basically two types of connection for inverter cooling circuits:

- Parallel connection to the condenser
- Serial connection to the condenser

Parallel connection

Below is the inverter water connection diagram. In this case, there is an on/off valve controlled based on the temperature read near the inverter's microprocessor. The set point and corresponding differential (fixed at 1 °C) must be set, keeping in consideration that the cooler parts of the board are below the controlled temperature and depend on the type of heat exchanger used to cool the inverter.

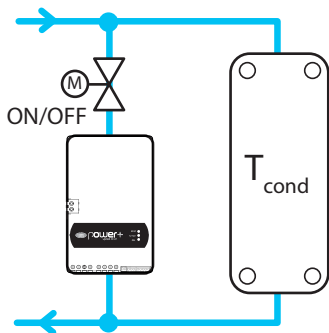
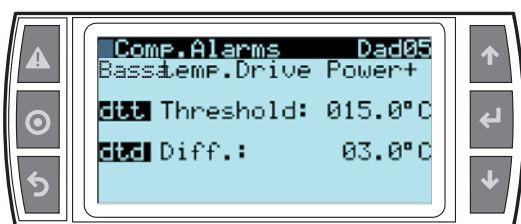

Fig. 6.ai

The on/off valve is selected in configuration branch Bad13, while the parameters are set on screen Dad05, used to select a minimum operating temperature threshold for the valve, below which the valve closes.



Note: If a digital output is selected (Bad13), the configuration is automatically set to "Parallel connection", while if the other configuration is required, no output must be selected for Bad13.

Serial connection

Below is the inverter water connection diagram. In this case, there is a modulating controlled based not on the temperature inside the inverter, but rather giving priority to the condensing pressure. For further control (temperature inside the inverter), a minimum condensing temperature threshold is set, below which the valve is progressively closed.

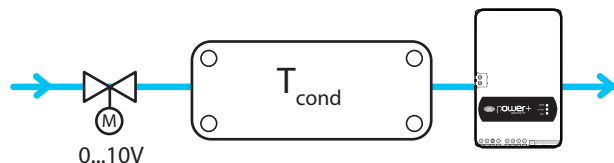
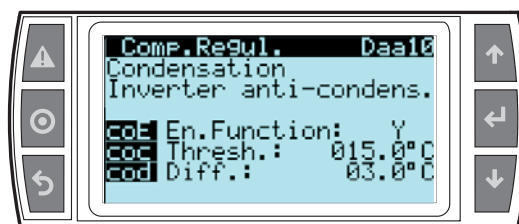

Fig. 6.aj

The modulating valve is selected in configuration branch Bab06 for condensing pressure control, the same for the control parameters. In addition, screen Daa10 is used to set and enable this safety threshold so that when the compressor is off, the valve is deactivated.

Note: The minimum inverter temperature with the compressor running is around ten degrees lower than the value read, and consequently the corresponding threshold should be set accordingly. In addition, special care should be paid to the values set, when need to be checked on the specific application. Otherwise, on low temperature showcases, air-cooled inverters can be used.



Par.	Description	Def	UoM	Min	Max
coE	Enable inverter anti-sweat 0= NO 1= YES	0		0	1
coc	Inverter anti-sweat temperature threshold	15.0 (59.0)	°C (°F)	0.0 (32.0)	50.0 (122.0)
cod	Inverter anti-sweat temperature differential	3.0 (5.4)	°C (°F)	0.0 (0.0)	10.0 (18.0)

7. PARAMETER TABLE

 **Mask index**: indicates the unique address of each screen and consequently the path needed to reach the parameters available on this screen; for example, to reach the parameters corresponding to the suction pressure probe with mask index Bab01, proceed as follows:

 Main menu  B. In./Out. → a. Status → b. Analog. in.

Below is the table of the parameters that can be displayed on the terminal. The values indicated with ‘---’ are not significant or are not set, while the values indicated with ‘...’ may vary according to the configuration, with the possible options visible on the user terminal. A row of ‘...’ means that there are a series of parameters similar to the previous ones.

 **Note**: not all the screens and parameters shown in the table are always visible or can be set, the screens and parameters that are visible or can be set depend on the configuration and the access level.

Mask index	Par.	Description	Default	UOM	Min	Max	Possible value descr.	R/W = Read / Write
Aa01		Select unit status	0	--	0	13	0: ON 1: UNIT OFF FROM ALARM 2: UNIT OFF FROM SUPERVIS. 3: UNIT OFF FROM TIME-BAND 4: UNIT OFF FROM DIG. INPUT 5: UNIT OFF FROM KEYPAD 6: DEFROST 7: DRIPPING 8: POST DRIPPING 9: DOOR OPEN 10: CONTINUOUS CYCLE 11: UNIT OFF FROM START-UP 12: MAINTENANCE 13: UNIT OFF FROM MASTER	R
	O/F	Select unit status	0	--	0	1	0: UNIT OFF 1: UNIT ON	R/W
Aa02	H2	Enable On/Off from supervisor	0	--	0	1	0: NO; 1: YES	R/W
	H3	Enable On/Off from keypad	1	--	0	1	0: NO; 1: YES	R/W
Ab01	J1	Run local defrost from keypad	0	--	0	1	0: NO; 1: YES	R/W
	J2	Run network defrost from keypad	0	--	0	1	0: NO; 1: YES	R/W
		Defrost temperature		°C (°F)				R
Ab03	J4	Management of light digital input	0	--	0	1	0: SWITCH LIGHTS ON 1: SWITCH LIGHTS OFF	R/W
Baa01	/FA	Select outlet temperature probe position (Sm)	1	--	0	10	0: -- 1: U01...10: U10 11: SR1 12: SR2 13: SR3 14: SR4 15: MST 16: SL1	R/W
		Select type of outlet temperature probe (Sm)	0	--	0	2	0: NTC 1: NTC-HT 2: PT1000	R/W
		Outlet temperature reading (Sm)		°C (°F)				R
		Outlet temperature probe offset (Sm)	0.0 (0.0)	°C (°F)	-50.0 (-90.0)	50.0 (90.0)		R/W
Baa02	/Fb	Select defrost temperature probe position (Sd)	2	--	0	10	0: -- 1: U01...10: U10 11: SR1 12: SR2 13: SR3 14: SR4 15: MST 16: SL1	R/W
		Select type of defrost temperature probe (Sd)	0	--	0	2	0: NTC 1: NTC-HT 2: PT1000	R/W
		Defrost temperature reading (Sd)		°C (°F)				R
		Defrost temperature probe offset (Sd)	0.0 (0.0)	°C (°F)	-50.0 (-90.0)	50.0 (90.0)		R/W
Baa03	/Fc	Select intake temperature probe position (Sr)	3	--	0	10	0: -- 1: U01...10: U10 11: SR1 12: SR2 13: SR3 14: SR4 15: MST 16: SL1	R/W
		Select type of intake temperature probe (Sr)	0	--	0	2	0: NTC 1: NTC-HT 2: PT1000	R/W
		Intake temperature reading (Sr)		°C (°F)				R
		Intake temperature probe offset (Sr)	0.0 (0.0)	°C (°F)	-50.0 (-90.0)	50.0 (90.0)		R/W
Baa04	/P3	Select condensing pressure probe position	7	--	0	10	0: -- 1: U01...10: U10 11: SR1 12: SR2 13: SR3 14: SR4 15: MST 16: SL1	R/W
		Select type of condensing pressure probe	0	--	0	3	0: RAT.0-5V 1: 4-20MA 2: 4-20MA REM 3: 4-20MA EXT	R/W
		Condensing pressure probe reading	0.0 (0.0)	barq/psig				R
		Maximum condensing pressure probe value	45.0 (650.0)	barq/psig	min	200.0 (2938.0)		R/W
		Minimum condensing pressure probe value	0.0 (0.0)	barq/psig	-1.0 (-14.7)	max		R/W
		Condensing pressure probe offset	0.0 (0.0)	bar/psi	-10.0 (-146.9)	10.0 (146.9)		R/W

Mask index	Par.	Description	Default	UOM	Min	Max	Possible value descr.	R/W
Baa05	/P4	Select evaporation pressure probe position	5		0	15	0: -- 1: U01...10: U10 11: SR1 12: SR2 13: SR3 14: SR4 15: MST 16: SL1	R/W
		Select type of evaporation pressure probe	0	--	0	3	0: RAT:0-5V 1: 4-20MA 2: 4-20MA REM 3: 4-20MA EXT	R/W
		Evaporation pressure probe value	17.3 (250.0)	barg/psig				R
		Maximum evaporation pressure probe value	0.0 (0.0)	barg/psig	min	200.0 (2938.0)		R/W
		Minimum evaporation pressure probe value	0.0 (0.0)	barg/psig	-1.0 (-14.7)	max		R/W
		Evaporation pressure probe offset	0.0 (0.0)	bar/psi	-10.0 (-146.9)	10.0 (146.9)		R/W
Baa06	/P1	Select discharge temperature probe position	6		0	10	0: -- 1: U01...10: U10 11: SR1 12: SR2 13: SR3 14: SR4 15: MST 16: SL1	R/W
		Select type of discharge temperature probe	1	--	0	5	0: CAREL NTC 1: CAREL NTC-HT 2: NTC SPKP**T0 3: TEMP:CUSTOM1 4: PT500	R/W
		Discharge temperature reading		°C (°F)				R
		Discharge temperature probe offset	0.0 (0.0)	°C (°F)	-50.0 (-90.0)	50.0 (90.0)		R/W
		Select suction temperature probe position	4		0	10	0: -- 1: U01...10: U10 11: SR1 12: SR2 13: SR3 14: SR4 15: MST 16: SL1	R/W
Baa07	/P2	Select suction temperature probe position	4		0	10	0: -- 1: U01...10: U10 11: SR1 12: SR2 13: SR3 14: SR4 15: MST 16: SL1	R/W
		Select type of suction temperature probe	0	--	0	5	0: NTC 1: NTC-HT 2: NTC SPKP**T0 3: 0-10V EXT. 4: TEMP:CUSTOM1 5: PT500	R/W
		Suction temperature reading		°C (°F)				R
		Suction temperature probe offset	0.0 (0.0)	°C (°F)	-50.0 (-90.0)	50.0 (90.0)		R/W
Baa08	/Fq	Select liquid temperature probe position	8		0	10	0: -- 1: U01...10: U10 11: SR1 12: SR2 13: SR3 14: SR4 15: MST 16: SL1	R/W
		Select type of liquid temperature probe	0	--	0	2	0: NTC 1: NTC-HT 2: PT1000	R/W
		Liquid temperature probe reading		°C (°F)				R
		Liquid temperature probe offset	0.0 (0.0)	°C (°F)	-50.0 (-90.0)	50.0 (90.0)		R/W
Baa09	/FI	Select room temperature probe position	0		0	15	0: -- 1: U01...10: U10 11: SR1 12: SR2 13: SR3 14: SR4 15: MST 16: SL1	R/W
		Select type of room temperature probe	0	--	0	2	0: NTC 1: NTC-HT 2: PT1000	R/W
		Room temperature probe reading		°C (°F)				R
		Room temperature probe offset	0.0 (0.0)	°C (°F)	-50.0 (-90.0)	50.0 (90.0)		R/W
Baa10	/FL	Select room humidity probe position	0		0	15	0: -- 1: U01...10: U10 11: SR1 12: SR2 13: SR3 14: SR4 15: MST 16: SL1	R/W
		Select type of room humidity probe	0	--	0	2	0: 4-20MA 1: 0-1V 2: 0-10V	R/W
		Room humidity probe reading		%rH				R
		Maximum room humidity probe value	100.0	%rH	min	100.0		R/W
		Minimum room humidity probe value	0.0	%rH	0.0	max		R/W
		Room humidity probe offset	0.0	%rH	-20.0	20.0		R/W
Baa11	/FM	Select glass temperature probe position	0		0	15	0: -- 1: U01...10: U10 11: SR1 12: SR2 13: SR3 14: SR4 15: MST 16: SL1	R/W
		Select type of glass temperature probe	0	--	0	2	0: NTC 1: NTC-HT 2: PT1000	R/W
		Glass temperature probe reading		°C (°F)				R

Mask index	Par.	Description	Default	UOM	Min	Max	Possible value descr.	R/W
Baa11		Glass temperature probe offset	0.0 (0.0)	°C (°F)	-50.0 (-90.0)	50.0 (90.0)		R/W
Baa12	/FW	Select water inlet temperature probe position	0		0	14	0: -- 1: U01...10: U10 11: SR1 12: SR2 13: SR3 14: SR4	R/W
		Select type of water inlet temperature probe	0	--	0	2	0: NTC 1: NTC-HT 2: PT1000	R/W
		Water inlet temperature probe reading		°C (°F)				R
		Water inlet temperature probe offset	0.0 (0.0)	°C (°F)	-50.0 (-90.0)	50.0 (90.0)		R/W
Baa13	/FY	Select water outlet temperature probe position	0		0	14	0: -- 1: U01...10: U10 11: SR1 12: SR2 13: SR3 14: SR4	R/W
		Select type of water outlet temperature probe	0	--	0	2	0: NTC 1: NTC-HT 2: PT1000	R/W
		Water outlet temperature probe reading		°C (°F)				R
		Water outlet temperature probe offset	0.0 (0.0)	°C (°F)	-50.0 (-90.0)	50.0 (90.0)		R/W
Baa14	/FG	Select position of auxiliary probe 1	0	--	0	15	0: -- 1: U01...10: U10 11: SR1 12: SR2 13: SR3 14: SR4 15: MST 16: SL1	R/W
		Select type of auxiliary probe 1	0	--	0	16	0: NTC 1: PT1000 2: 0/1V 3: 0/10V 4: 4/20MA 5: 0/20MA 6: ON/OFF 7: 0/5V RAT. 9: NTC HT 13: PTC 14: PT500 15: PT100	R/W
		Select function of auxiliary probe 1	0	--	0	3	0: TEMPERATURE 1: PRESSURE 2: HUMIDITY 3: GENERIC	R/W
		Auxiliary probe 1		°C (°F) /%rH/barg				R
		Minimum value of range for auxiliary probe 1	0.0 (32.0)	°C (°F) /%rH/barg	-999.9	max		R/W
		Maximum value of range for auxiliary probe 1	0.0 (32.0)	°C (°F) /%rH/barg	min	999.9		R/W
		Auxiliary probe 1 offset	0.0 (0.0)	°C (°F) /%rH/barg	-999.9	999.9		R/W
Baa15	/FH	Select position of auxiliary probe 2	0	--	0	15	0: -- 1: U01...10: U10 11: SR1 12: SR2 13: SR3 14: SR4 15: MST 16: SL1	R/W
		Select type of auxiliary probe 2	0	--	0	16	0: NTC 1: PT1000 2: 0/1V 3: 0/10V 4: 4/20MA 5: 0/20MA 6: ON/OFF 7: 0/5V RAT. 9: NTC HT 13: PTC 14: PT500 15: PT100	R/W
		Select function of auxiliary probe 2	0	--	0	3	0: TEMPERATURE 1: PRESSURE 2: HUMIDITY 3: GENERIC	R/W
		Auxiliary probe 2		°C (°F) /%rH/barg				R
		Minimum value of range for auxiliary probe 2	0.0 (32.0)	°C (°F) /%rH/barg	-999.9	max		R/W
		Maximum value of range for auxiliary probe 2	0.0 (32.0)	°C (°F) /%rH/barg	min	999.9		R/W
		Auxiliary probe 2 offset	0.0 (0.0)	°C (°F) /%rH/barg	-999.9	999.9		R/W
Baa16	/FO	Condenser air outlet temperature	0		0	14	0: -- 1: U01...10: U10 11: SR1 12: SR2 13: SR3 14: SR4	R/W
		Select type of condenser air outlet temperature	0	--	0	2	0: NTC 1: NTC-HT 2: PT1000	R/W
		Condenser air outlet temperature		°C (°F)				R
		Condenser air outlet temperature probe offset	0.0 (0.0)	°C (°F)	-50.0 (-90.0)	50.0 (90.0)		R/W
Bab01	/LA	Select modulating fan output position	0	--	0	3	0: -- 1: AO1 2: AO2 3: AO3	R/W
		Modulating fan output % reading	0	%	0	100		R
Bab02	/Lb	Select anti-sweat heater output position	0	--	0	3	0: -- 1: AO1 2: AO2 3: AO3	R/W
		Anti-sweat heater output % reading	0	%	0	100		R

Mask index	Par.	Description	Default	UOM	Min	Max	Possible value descr.	R/W
Bab05	/LE	Select auxiliary output position	0	--	0	3	0: -- 1: AO1 2: AO2 3: AO3	R/W
		Auxiliary output % reading	0	%	0	100		R
Bab06	/LF	Select water-cooled condenser output position	0	--	0	3	0: -- 1: AO1 2: AO2 3: AO3	R/W
		Water-cooled condenser output % reading	0	%	0	100		R
Bab07	/LG	Select air-cooled condenser output position	0	--	0	3	0: -- 1: AO1 2: AO2 3: AO3	R/W
		Air-cooled condenser output % reading	0	%	0	100		R
Bac01	/b1	Select remote alarm input position	0	--	0	MaxPosDin	0: -- 1: DI1 2: DI2 3: DI3 4: DI4 5: MST	R/W
		Remote alarm input status	0	--	0	1	0: CLOSED 1: OPEN	R
		Select remote alarm input logic	0	--	0	1	0: N.C.; 1: N.A.	R/W
		Remote alarm input function	0	--	0	1	0: NOT ACTIVE 1: ACTIVE	R
Bac02	/b2	Select delayed remote alarm input position	0	--	0	5	0: -- 1: DI1 2: DI2 3: DI3 4: DI4 5: MST	R/W
		Delayed remote alarm input status	0	--	0	1	0: CLOSED 1: OPEN	R
		Select delayed remote alarm input logic	0	--	0	1	0: N.C.; 1: N.A.	R/W
		Delayed remote alarm input function	0	--	0	1	0: NOT ACTIVE 1: ACTIVE	R
Bac03	/b3	Select enable defrost input position	0	--	0	5	0: -- 1: DI1 2: DI2 3: DI3 4: DI4 5: MST	R/W
		Enable defrost input status	0	--	0	1	0: CLOSED 1: OPEN	R
		Select enable defrost input logic	0	--	0	1	0: N.C.; 1: N.A.	R/W
		Enable defrost input function	0	--	0	1	0: NOT ACTIVE 1: ACTIVE	R
Bac04	/b4	Select start network defrost input position	0	--	0	5	0: -- 1: DI1 2: DI2 3: DI3 4: DI4 5: MST	R/W
		Start network defrost input status	0	--	0	1	0: CLOSED 1: OPEN	R
		Select start network defrost input logic	0	--	0	1	0: N.C.; 1: N.A.	R/W
		Start network defrost input function	0	--	0	1	0: NOT ACTIVE 1: ACTIVE	R
Bac05	/b5	Select door sensor input position	0	--	0	5	0: -- 1: DI1 2: DI2 3: DI3 4: DI4 5: MST	R/W
		Door sensor input status	0	--	0	1	0: CLOSED 1: OPEN	R
		Select door sensor input logic	0	--	0	1	0: N.C.; 1: N.A.	R/W
		Door sensor input function	0	--	0	1	0: NOT ACTIVE 1: ACTIVE	R
Bac06	/b6	Select remote on/off input position	0	--	0	5	0: -- 1: DI1 2: DI2 3: DI3 4: DI4 5: MST	R/W
		Remote on/off input status	0	--	0	1	0: CLOSED 1: OPEN	R
		Select remote on/off input logic	0	--	0	1	0: N.C.; 1: N.A.	R/W
		Remote on/off input function	0	--	0	1	0: NOT ACTIVE 1: ACTIVE	R
Bac07	/b7	Select Day/Night input position	0	--	0	5	0: -- 1: DI1 2: DI2 3: DI3 4: DI4 5: MST	R/W
		Day/Night input status	0	--	0	1	0: CLOSED 1: OPEN	R
		Select Day/Night input logic	0	--	0	1	0: N.C.; 1: N.A.	R/W
		Day/Night input function	0	--	0	1	0: NOT ACTIVE 1: ACTIVE	R

Mask index	Par.	Description	Default	UOM	Min	Max	Possible value descr.	R/W
Bac09	/b9	Select curtain contact output position	0	--	0	5	0: -- 1: DI1 2: DI2 3: DI3 4: DI4 5: MST	R/W
		Curtain contact output status	0	--	0	1	0: CLOSED 1: OPEN	R
		Select curtain contact output logic	0	--	0	1	0: N.C.; 1: N.A.	R/W
		Curtain contact output function	0	--	0	1	0: NOT ACTIVE 1: ACTIVE	R
Bac10	/bA	Select showcase cleaning input position	0	--	0	5	0: -- 1: DI1 2: DI2 3: DI3 4: DI4 5: MST	R/W
		Showcase cleaning input status	0	--	0	1	0: CLOSED 1: OPEN	R
		Select showcase cleaning input logic	0	--	0	1	0: N.C.; 1: N.A.	R/W
		Showcase cleaning input function	0	--	0	1	0: NOT ACTIVE 1: ACTIVE	R
Bac11	/bb	Select inverter alarm input position	0	--	0	5	0: -- 1: DI1 2: DI2 3: DI3 4: DI4 5: MST	R/W
		Inverter alarm input status	0	--	0	1	0: CLOSED 1: OPEN	R
		Select inverter alarm input logic	0	--	0	1	0: N.C.; 1: N.A.	R/W
		Inverter alarm input function	0	--	0	1	0: NOT ACTIVE 1: ACTIVE	R
Bac12	/bC	Select showcase light input position	0	--	0	MaxPosDin	0: -- 1: DI1 2: DI2 3: DI3 4: DI4 5: MST	R/W
		Showcase light input status	0	--	0	1	0: CLOSED 1: OPEN	R
		Select showcase light input logic	0	--	0	1	0: N.C.; 1: N.A.	R/W
		Showcase light input function	0	--	0	1	0: NOT ACTIVE 1: ACTIVE	R
Bac14	A9	Select virtual digital input	0	--	0	4		R/W
		Display type of virtual digital input	0	--	0	13	0: -- 1: REMOTE ALARM 2: DELAYED REMOTE ALARM 3: ENABLE DEFROST 4: START NETWORK DEF. 5: DOOR CONTACT 6: REMOTE ON/OFF 7: DAY/NIGHT 9: COLD ROOM MAINT. 10: SHOWCASE CLEANING 11: INVERTER ALARM 12: SHOWCASE LIGHTS 13: CURTAIN CONTACT	R
Bad01	/EA	Select fan output 1 position	6	--	0	8	0: -- 1: DO1 2: DO2 3: DO3 4: DO4 5: DO5 6: DO6 7: DO7 8: DO8	R/W
		Fan output 1 status	0	--	0	1	0: OPEN 1: CLOSED	R
		Select fan output 1 logic	0	--	0	1	0: N.A.; 1: N.C.	R/W
		Fan output 1 function	0	--	0	1	0: NOT ACTIVE 1: ACTIVE	R
Bad03	/EC	Select light output position	7	--	0	8	0: -- 1: DO1 2: DO2 3: DO3 4: DO4 5: DO5 6: DO6 7: DO7 8: DO8	R/W
		Light output status	0	--	0	1	0: OPEN 1: CLOSED	R
		Select light output logic	0	--	0	1	0: N.A.; 1: N.C.	R/W
		Light output function	0	--	0	1	0: NOT ACTIVE 1: ACTIVE	W
Bad04	/Ed	Select defrost output position	8	--	0	8	0: -- 1: DO1 2: DO2 3: DO3 4: DO4 5: DO5 6: DO6 7: DO7 8: DO8	R/W
		Defrost output status	0	--	0	1	0: OPEN 1: CLOSED	R
		Select defrost output logic	0	--	0	1	0: N.A.; 1: N.C.	R/W
		Defrost output function	0	--	0	1	0: NOT ACTIVE 1: ACTIVE	W

Mask index	Par.	Description	Default	UOM	Min	Max	Possible value descr.	R/W
Bad05	/EE	Select alarm output position	1	--	0	8	0: -- 1: DO1 2: DO2 3: DO3 4: DO4 5: DO5 6: DO6 7: DO7 8: DO8	R/W
		Alarm output status	0	--	0	1	0: OPEN 1: CLOSED	R
		Select alarm output logic	0	--	0	1	0: N.A; 1: N.C.	R/W
		Alarm output function	0	--	0	1	0: NOT ACTIVE 1: ACTIVE	W
Bad06	/EF	Select auxiliary output position	0	--	0	8	0: -- 1: DO1 2: DO2 3: DO3 4: DO4 5: DO5 6: DO6 7: DO7 8: DO8	R/W
		Auxiliary output status	0	--	0	1	0: OPEN 1: CLOSED	R
		Select auxiliary output logic	0	--	0	1	0: N.A; 1: N.C.	R/W
		Auxiliary output function	0	--	0	1	0: NOT ACTIVE 1: ACTIVE	W
Bad07	/EG	Select anti-sweat heater output position	0	--	0	3	0: -- 1: -- 2: DO2 3: DO3	R/W
		Anti-sweat heater output status	0	--	0	1	0: OPEN 1: CLOSED	R
		Select anti-sweat heater output logic	0	--	0	1	0: N.A; 1: N.C.	R/W
		Anti-sweat heater output function	0	--	0	1	0: NOT ACTIVE 1: ACTIVE	W
Bad08	/EM	Select liquid injection solenoid output position	0	--	0	8	0: -- 1: DO1 2: DO2 3: DO3 4: DO4 5: DO5 6: DO6 7: DO7 8: DO8	R/W
		Liquid injection solenoid output status	0	--	0	1	0: CLOSED 1: OPEN	R
		Select liquid injection solenoid output logic	0	--	0	1	0: N.A; 1: N.C.	R/W
		Liquid injection solenoid output function	0	--	0	1	0: NOT ACTIVE 1: ACTIVE	W
Bad09	/EN	Select curtain contact output position	0	--	0	8	0: -- 1: DO1 2: DO2 3: DO3 4: DO4 5: DO5 6: DO6 7: DO7 8: DO8	R/W
		Curtain contact output status	0	--	0	1	0: CLOSED 1: OPEN	R
		Select curtain contact output logic	0	--	0	1	0: N.A; 1: N.C.	R/W
		Curtain contact output function	0	--	0	1	0: NOT ACTIVE 1: ACTIVE	W
Bad10	/Eo	Select position of ON/OFF compressor output	0	--	0	8	0: -- 1: DO1 2: DO2 3: DO3 4: DO4 5: DO5 6: DO6 7: DO7 8: DO8	R/W
		Status of ON/OFF compressor output	0	--	0	1	0: CLOSED 1: OPEN	R
		Select logic of ON/OFF compressor output	0	--	0	1	0: N.A; 1: N.C.	R/W
		ON/OFF compressor output function	0	--	0	1	0: NOT ACTIVE 1: ACTIVE	W
Bad13	/Er	Select inverter valve output position	0	--	0	8	0: -- 1: DO1 2: DO2 3: DO3 4: DO4 5: DO5 6: DO6 7: DO7 8: DO8	R/W
		Inverter valve output status	0	--	0	1	0: OPEN 1: CLOSED	R
		Select inverter valve output logic	0	--	0	1	0: N.O. 1: N.C.	R/W
		Inverter valve output function output	0	--	0	1	0: NOT ACTIVE 1: ACTIVE	W

Mask index	Par.	Description	Default	UOM	Min	Max	Possible value descr.	R/W
Bad14	/ES	Select condenser fan output position	0	--	0	8	0: -- 1: DO1 2: DO2 3: DO3 4: DO4 5: DO5 6: DO6 7: DO7 8: DO8	R/W
		Condenser fan output status	0	--	0	1	0: OPEN 1: CLOSED	R
		Select condenser fan output logic	0	--	0	1	0: N.O. 1: N.C.	R/W
		Condenser fan output function	0	--	0	1	0: NOT ACTIVE 1: ACTIVE	W
Bb01	J5	Enable manual procedure	0	--	0	1	0: NO; 1: YES	R/W
		Select status of DO1-DO4	0	--	0	17	0: NOT CONFIGURED 1: FANS 1 3: LIGHTS 4: DEFROST 5: ALARM 6: AUX. OUTPUT 7: ANTI-SWEAT HEAT. 13: LIQ. INJ. SOLEN. 14: CURTAIN CONTACT 15: ON/OFF COMP. 16: HEAT RECOVERY 17: COND. BYPASS.	R
Bb02	J6	Manual management status of DO1-DO4	0	--	0	1	0: NO; 1: YES	R/W
	J6	Display configuration of DO5-DO8	0	--	0	17	0: NOT CONFIGURED 1: FANS 1 3: LIGHTS 4: DEFROST 5: ALARM 6: AUX. OUTPUT 7: ANTI-SWEAT HEAT. 13: LIQ. INJ. SOLEN. 14: CURTAIN CONTACT 15: ON/OFF COMP. 16: HEAT RECOVERY 17: COND. BYPASS.	R
Bb03		Manual management status of DO5-DO8	0	--	0	1	0: NO; 1: YES	R/W
	J7	Display analogue output configuration AO1-AO3	0	--	0	7	0: NOT CONFIGURED 1: FANS 2: ANTI-SWEAT HEAT. 5: AUX OUTPUT. 6: WATER COND. 7: AIR COND.	R
Bb04		% analogue outputs in manual mode	0.0	--	0.0	100.0		R/W
	J8	Enable compressor in manual mode	0	--	0	1	0: NO; 1: YES	R/W
Bb05	J9	Compressor capacity percentage in manual mode	0.0	--	0.0	100.0		R/W
	PMP	Enable manual expansion valve positioning	0	--	0	1	0: AUTO 1: MAN.	R/W
Ca01	PMu	Manual expansion valve position	0	steps	0	480		R/W
	tPS	Type of set point in multi-evaporator configuration	0		0	1	0: TEMPERATURE 1: PRESSURE	R/W
	tPU	Pressure set point set as:	0		0	1	0: TEMPERATURE 1: PRESSURE	R/W
Ca02	St	User temperature set point	2.0 (35.6)	°C (°F)	r1	r2		R/W
		Current temperature set point (read-only)		°C (°F)				R
Ca03	/4	Virtual probe composition (weighted average Sr, Sm)	0	%	0	100		R/W
	Kp	Temperature control differential	10	%°C	1	200		R/W
Ca04	tl	Compressor control integral time	500	s	0	999		R/W
	StP	Pressure control set point	5.8 (84.1)	barq (psiq)	1.2 (17.3)	8.3 (121.9)		R/W
	KpP	Pressure control proportional coeff.	10	%/bar	1	200		R/W
Ca05	tiP	Compressor control integral time	500	s	0	999		R/W
	r0	Control offset with probe error (intake, outlet)	5.0 (9.0)	°C (°F)	0.0 (0.0)	20.0 (36.0)		R/W
Cba01	r4	Set point offset in night mode	3.0 (5.4)	°C (°F)	-50.0 (-90.0)	50.0 (90.0)		R/W
		Pressure set point offset in night mode	0	bar (psi)	-99.9 (-1.449)	99.9 (1.449)		
	r6	Enable night-time control on intake probe (Sr)	0	--	0	1	0: NO; 1: YES	R/W
Cbb01	HL	Enable lights off at night	1	--	0	1	0: NO; 1: YES	R/W
	S1	Night time band 1	0	--	0	11	0: NONE 1: MON 2: TUE 3: WED 4: THU 5: FRI 6: SAT 7: SUN 8: MON-FRI 9: MON-SAT 10: WEEKEND 11: ALWAYS	R/W
	hS1	Night start hours	0	h	0	23		R/W
	mS1	Night start minutes	0	min	0	59		R/W
	hE1	Night end hours	0	h	0	23		R/W
	mE1	Night end minutes	0	min	0	59		R/W

Mask index	Par.	Description	Default	UOM	Min	Max	Possible value descr.	R/W
Cbb02	S2	Night time band 2	0	--	0	11	0: NONE 1: MON 2: TUE 3: WED 4: THU 5: FRI 6: SAT 7: SUN 8: MON-FRI 9: MON-SAT 10: WEEKEND 11: ALWAYS	R/W
	hS2	Night start hours	0	h	0	23		R/W
	mS2	Night start minutes	0	min	0	59		R/W
	hE2	Night end hours	0	h	0	23		R/W
Cbb03	mE2	Night end minutes	0	min	0	59		R/W
	S3	Night time band 3	0	--	0	11	0: NONE 1: MON 2: TUE 3: WED 4: THU 5: FRI 6: SAT 7: SUN 8: MON-FRI 9: MON-SAT 10: WEEKEND 11: ALWAYS	R/W
	hS3	Night start hours	0	h	0	23		R/W
	mS3	Night start minutes	0	min	0	59		R/W
Cc01	hE3	Night end hours	0	h	0	23		R/W
	mE3	Night end minutes	0	min	0	59		R/W
Cc02	r1	Minimum control set point limit	-50.0 (-58.0)	°C (°F)	-50.0 (-58.0)	max		R/W
	r2	Maximum control set point limit	50.0 (122.0)	°C (°F)	min	50.0 (122.0)		R/W
Daa01	Pr1	Minimum pressure control set point limit	1.2 (17.3)	barg (psig)	1.2 (17.3)	8.3 (121.9)		R/W
	Pr2	Maximum pressure control set point limit	8.3 (121.9)	barg (psig)	1.2 (17.3)	8.3 (121.9)		R/W
Daa02	Kp	Temperature control proportional coefficient	10	%/°C	1	200		R/W
	tl	Compressor control integral time	500	s	0	999		R/W
Daa03	cE1	Select equalising procedure mode	0	--	0	1	0: EEV PRE-OPENING 1: EQUAL. VALVE	R/W
	cE2	Maximum EEV opening time during equalisation	90	s	0	999		R/W
	cE3	EEV pre-opening percentage during equalisation	60	%	20	99.9		R/W
Daa04	LIV	Type of liquid injection valve	0	--	0	1	0: ON-OFF 1: EEV	R/W
	LIt	Liquid injection function activation threshold	95.0 (203.0)	°C (°F)	50.0 (122.0)	150.0 (302.0)		R/W
	LIP	Liquid injection control proportional coefficient	5	--	1	200	WITH LIV = 1	R/W
	LII	Liquid injection control integral time	100	s	1	999	WITH LIV = 1	R/W
	LId	Liquid injection differential	5.0 (9.0)	°C (°F)	0.1 (0.2)	20.0 (36.0)	WITH LIV = 0	R/W
	LlC	Duty Cycle	100	%	0	100	WITH LIV = 0	R/W
Daa05	LIS	Duty Cycle period	30	s	0	60	WITH LIV = 0	R/W
	dts	Discharge temperature set point managed by EEV	100.0 (212)	°C (°F)	50.0 (122.0)	150.0 (302.0)		R/W
	dtD	Discharge temperature differential managed by EEV	1.0 (1.8)	°C (°F)	0.1 (0.2)	20.0 (36.0)		R/W
Daa06	dto	Discharge temperature offset managed by EEV	2.0 (3.6)	°C (°F)	0.0 (0.0)	99.9 (179.8)		R/W
	ch1	Discharge temperature limit (red. comp. speed)	100.0 (212)	°C (°F)	50.0 (122.0)	150.0 (302.0)		R/W
	ch2	Discharge temperature alarm	105.0 (221.0)	°C (°F)	50.0 (122.0)	150.0 (302.0)		R/W
	ch3	Discharge temperature activation differential (red. comp. speed)	20.0 (36.0)	°C (°F)	0.1 (0.2)	30.0 (48.0)		R/W
	ch4	Pause in speed reduction over discharge temperature limit (red. comp. speed)	90	s	1	300		R/W
Daa07	ch5	Speed reduction percent over discharge temperature limit	3.0	%	0.5	20		R/W
	co1	Type of condenser cooling	0		0	1	0: WATER 1: AIR	R/W
Daa09	co3	Type of water-cooled condenser control	0		0	3	0: COND.TEMP. 1: W OUT-TEMP. 2: W OUT TEMP. 3: W IN TEMP.	R/W
	co4	Condensing temp. set point	20.0 (68.0)	°C (°F)	10.0 (50.0)	55.0 (131.0)		R/W
	co4	Condenser water temp. diff. set point	5.0 (9.0)	°C (°F)	0.1 (0.18)	20.0 (36.0)		R/W
	co5	Cond. control proportional coefficient	40	%/°C	1	999		R/W
	co6	Cond. control integral time	100	s	0	999		R/W
	Daa10	coA	Cond. control safety set point	42.0 (107.6)	°C (°F)	30.0 (86.0)	55.0 (131.0)	
coB		Cond. control safety differential	5.0 (9.0)	°C (°F)	0.0 (0.0)	9.9 (17.8)		R/W
Daa11	coE	Enable inverter anti-sweat	0		0	1	0: NO 1: YES	R/W
	coc	Inverter anti-sweat temperature threshold	15.0 (59.0)	°C (°F)	0.0 (32.0)	50.0 (122.0)		R/W
	cod	Inverter anti-sweat temperature differential	3.0 (5.4)	°C (°F)	0.0 (0.0)	10.0 (18.0)		R/W
	com	Minimum % fan/valve output	0.0	%	0.0	100		R/W
	con	Maximum % fan/valve output	100	%	0.0	100		R/W
Dab01	coo	Valve closing delay from compressor shutdown	10	s	0	999		R/W
		Compressor model used	0	--	0	1	0: BLDC 1: ON/OFF	

Mask index	Par.	Description	Default	UOM	Min	Max	Possible value descr.	R/W
Dab02		Model of compressor used	52	--	-	-	26: HIT ZS1216-7798D1-230V 50: TOSHIBA DA91A1F-230V 51: TOSHIBA DA130A1F-230V 52: TOSHIBA DA220A2F-230V 53: TOSHIBA DA330A3F-230V 54: TOSHIBA DA420A3F-230V	R/W
		Refrigerant type	2	--	0	13	0: R22 1: R134A 2: R404A 3: R407C 4: R410A 5: R507A 6: R290 (PROPANE) 7: R600 (BUTANE) 8: R600A (ISOBUTANE) 9: R717 (AMMONIA) 10: R744 11: R728 (NITROGEN) 12: R1270 (PROPYLENE) 13: R417A	R
		Power supply	0	--	0	1	0: 230V 1: 400V	R
		Write parameters for the selected compressor	1	--	0	1	0: NO; 1: YES	R/W
Dab03	c0	Start control delay at power on	0	min	0	15		R/W
	c1	Minimum time between successive compressor calls	6	min	0	15		R/W
	c2	Minimum compressor off time	3	min	0	15		R/W
	c3	Minimum on compressor time	3	min	0	15		R/W
Dab04	cl3	Compressor capacity percentage with probe alarm	50	%	0	100		R/W
	c4	Comp. on time in duty setting from probe alarm	3	min	0	100	0: ALWAYS ON	R/W
	c5	Comp. off time in duty setting from probe alarm	3	min	0	100		R/W
Dab05	cl5	Maximum pressure delta for compressor start ?	0.5 (7.3)	bar/psi	0.0 (0.0)	120 (1762.8)		R/W
	cl6	Minimum pressure delta for compressor start ?	0.2 (2.9)	bar/psi	0.1 (1.5)	2.0 (29.4)		R/W
	cl7	Pressure delta control delay to check comp. start-up	10	s	1	99		R/W
Dab06	cl8	Restart delay after failed start	30	s	1	360		R/W
	cl9	Number of restart attempts after failed start	5	--	0	9		R/W
Dab07	clA	Compressor speed when starting	50.0	rps	clc	clb		R/W
	clb	Maximum compressor speed	Comp	rps	clc	Type comp		R/W
	clc	Minimum compressor speed	Comp	rps	Type comp	clb		R/W
Dab08	clD	Maximum speed increase (control)	1.0	rps/s	0.1	Type comp		R/W
	clE	Maximum speed decrease (control)	1.0	rps/s	0.1	Type comp		R/W
	clF	Maximum speed decrease (shutdown)	1.0	rps/s	0.1	Type comp		R/W
Dab09	clH	Acceleration decrease (to return inside envelope)	0.5	rps/s	0.1	Type comp		R/W
	clI	Minimum comp. speed to remain inside envelope	Comp	rps	Type comp	clb		R/W
	clJ	Out of envelope alarm delay	60	s	0	600		R/W
Dab10	clL	Low compression ratio alarm delay	180	s	1	600		R/W
	cln	Enable low compression ratio management by closing EEV	1	--	0	1	0: NO; 1: YES	R/W
	clo	Enable increase comp. speed with low compression ratio	1	--	0	1	0: NO; 1: YES	R/W
Dab11	clP	Enable oil recovery management	1	--	0	1	0: NO; 1: YES	R/W
	clr	Oil recovery procedure activation time	30	min	1	480		R/W
	clS	Compressor override time during procedure	2	min	1	10		R/W
Dab12	clu	Minimum comp. output to activate oil recovery procedure	Comp	%	10.0	99.9		R/W
	clV	Comp. speed during oil recovery procedure	100	%	0	100		R/W
Dad01	Al1	Set high compressor pressure	33.0 (484.7)	barq/psiq	-1.0 (-14.7)	200.0 (2938.0)		R/W
	Al2	High compressor pressure differential	3.0 (44.1)	bar/psi	0.0 (0.0)	20.0 (293.8)		R/W
Dad02	Al3	Set low compressor pressure	0.5 (7.3)	barq/psiq	-1.0 (-14.7)	200.0 (2938.0)		R/W
	Al4	Low pressure compressor differential	2.0 (29.4)	bar/psi	0.0 (0.0)	20.0 (293.8)		R/W
Dad03	Al5	Low compressor pressure alarm delay at start-up	30	s	0	999		R/W
	Al6	Low compressor pressure alarm delay in steady operation	5	s	0	999		R/W
	Al7	Type of low compressor pressure alarm reset	0	--	0	1	0: 5 ATTEMPTS 1: 0 ATTEMPTS	R/W
Dad04	Al8	Type of envelope alarm reset	0	--	0	1	0: SEMIAUT. 1: MANUAL	R/W
	AlA	Time range	60	min	0	999		R/W
	Alb	No. of attempts performed	5	--	0	10		R/W
Dad05	Al9	Type of Power+ alarm reset	0	--	0	1	0: SEMIAUT. 1: MANUAL	R/W
	AlC	Time range	60	min	0	999		R/W
	Ald	No. of attempts performed	5	--	0	10		R/W
Dad06	dtT	Low inverter temperature threshold	2.0 (3.6)	°C (°F)	-99.9 (-147.8)	99.9 (212.0)		R/W
	dtD	Inverter temperature differential	3.0 (5.4)	°C (°F)	0.0 (0.0)	10.0 (18.0)		R/W
Dba01	P3	Superheat set point	10.0 (36.0)	°C (°F)	0.0 (0.0)	30.0 (54.0)		R/W
Dba02	P4	PID: EEV proportional gain	15.0		0.0	100.0		R/W
	P5	PID: EEV integral time	150	s	0	999		R/W
	P6	PID: EEV derivative time	5.0	s	0.0	100.0		R/W
Dbb01	EVP	EEV present	1	-	0	1	0: NO PRESENT 1: PRESENT	
Dbb02	PH	Refrigerant type (depends on selected compressor)	Comp	--	0	13	0: R22 1: R134A 2: R404A 3: R407C 4: R410A 5: R507A 6: R290 (PROPANE) 7: R600 (BUTANE) 8: R600A (ISOBUTANE) 9: R717 (AMMONIA) 10: R744 11: R728 (NITROGEN) 12: R1270 (PROPYLENE) 13: R417A	R
Dbb03	CP1	EEV opening at power on	50	%	0	100		R/W
	Psb	Enable EEV opening in standby	0	--	0	1	0: NO; 1: YES	R/W
	cP2	EEV pre-positioning delay	6	s	0	300.0		R/W
Dbc01	P7	Low superheat threshold	2.0 (35.6)	°C (°F)	0.0 (32.0)	30.0 (86.0)		R/W
	P8	LowSH: EEV low superheat integral time	10	s	0.0	999		R/W
	P9	LowSH: EEV low superheat alarm delay	120	s	0	300.0		R/W

Mask index	Par.	Description	Default	UOM	Min	Max	Possible value descr.	R/W
Dbc02	PL1	LOP	-50.0 (-58.0)	°C (°F)	-50.0 (-58.0)	MOP		R/W
	PL2	LOP: Low evaporation temperature integral time	10	s	0.0	999		R/W
	PL3	LOP: Low evaporation temperature alarm delay	120	s	0	300.0		R/W
Dbc03	PM1	MOP	15.0 (59.0)	°C (°F)	LOP	30.0 (86.0)		R/W
	PM2	MOP: High evaporation temperature integral time	20.0	s	0.0	999		R/W
	PM3	MOP: High evaporation temperature alarm delay	240	s	0	300.0		R/W
Dbc04	P11	Low suction temperature alarm threshold	-40.0 (-40.0)	°C (°F)	-50.0 (-58.0)	30.0 (86.0)		R/W
	P12	Low suction temperature alarm delay	120	s	0	300		R/W
Dbc05	Pa	High superheat threshold	35.0 (95.0)	°C (°F)	0.0 (32.0)	50.0 (122.0)		R/W
	Pb	High superheat alarm delay	600	s	0	999		R/W
Dbc06	Pb1	Valve threshold position warning	99	%	0	100		R/W
	Pb2	Alarm delay	10	min	0	999		R/W
Dbc07	Pb3	Superheat offset setpoint for low refrigerant charge warning	3.0 (5.4)	°C (°F)	0 (0)	20.0 (36.0)		R/W
	Pb4	Alarm delay	10	min	0	999		R/W
Dca01	d0	Type of defrost/end defrost	0	--	0	6	0: ELECTR./TEMP-TIMEOUT 1: INV. CYCLE/TEMP-TIMEOUT 2: ELECTR./ ONLY TIMEOUT 3: INV. CYCLE/ ONLY TIMEOUT 4: ELECTRICAL/ REGUL. TEMPERAT. TIME 5: BYPASS HOT-GAS / TEMP-TIMEOUT 6: BYPASS HOT-GAS/ ONLY TIMEOUT	R/W
Dca02	dt1	End defrost temperature	8.0 (46.4)	°C (°F)	-50.0 (-58.0)	50.0 (122.0)		R/W
	dP1	Maximum defrost duration	40	min	1	240		R/W
	dd	Dripping time after defrost (fans off)	120	s	0	600		R/W
	d9	Disable evaporation pressure alarm in defrost	0	--	0	1	0: NO; 1: YES	R/W
Dca03	d1	Interval between two consecutive defrosts 0=disabled	8	h	0	500		R/W
	d4	Enable defrost at start-up	0	--	0	1	0: NO; 1: YES	R/W
Dca04	d5	Defrost delay at start-up or from digital input	0	min	0	240		R/W
	r3	Enable end defrost signal for maximum time	0	--	0	1	0: NO; 1: YES	R/W
	d2	Defrost control in pLAN	1	--	0	2	0: START ONLY 1: START & END 2: LOCAL ONLY	R/W
Dca05	d8	High temperature alarm bypass time after defrost and/or door open	30	min	0	240		R/W
	d13	Restart control delay during maintenance 0=disabled	0	min	0	240		R/W
	dR1	Enable compressor OFF in defrost	0	--	0	1	0: NO; 1: YES	R/W
Dca06	/10	Select probe used for end defrost (d0=4)	2	--	0	3	0: CONTROL PROBE 1: OUTLET PROBE 2: DEFROST PROBE 3: INTAKE PROBE	R/W
	dG2	Compressor speed (defrost by reversing cycle)	50.0	rps	clc	clb		R/W
	dG3	Maximum acceleration in defrost by reversing cycle	1.0	rps	clid	clE		R/W
Dca07	dG4	Out of envelope alarm delay (defrost by reversing cycle)	600	s	0	999		R/W
	dG5	4-way valve changeover delay in Defrost	10	s	0	99		R/W
	dG6	4-way valve changeover delay after defrost	10	s	0	99		R/W
Dca08	dG7	End defrost delay (defrost by reversing cycle)	60	s	0	180		R/W
	dG8	EXV mode at start defrost	1	--	0	1	0: REG; 1: MAN	R/W
		Manual EXV opening at start defrost	50	%	0	100		R/W
	dG9	EXV mode during defrost	1	--	0	1	0: REG; 1: MAN	R/W
		Manual EXV opening during defrost	50	%	0	100		R/W
Dca09	dG10	EXV mode at end defrost	1	--	0	1	0: REG; 1: MAN	R/W
		Manual EXV opening at end defrost	50	%	0	100		R/W
	dH2	Compressor speed (hot gas defrost)	80.0	%	clc	clb		R/W
Dca10	dH4	Out of envelope alarm delay (hot gas defrost)	600	s	0	999		R/W
	dH5	Bypass valve opening delay (hot gas defrost)	10	s	0	99		R/W
Dcb01...4	dH6	Bypass valve closing delay (hot gas defrost)	10	s	0	99		R/W
	td1...8	Scheduled defrost day	0	--	0	11	0: NONE 1: MON 2: TUE 3: WED 4: THU 5: FRI 6: SAT 7: SUN 8: MON-FRI 9: MON-SAT 10: WEEKEND 11: ALWAYS	R/W
	tt1...8	Scheduled defrost hours	0	--	0	23		R/W
	tt1...8	Scheduled defrost minutes	0	--	0	59		R/W
Dcc01	tP1...8	Enable Power Defrost	0	--	0	1	0: NO; 1: YES	R/W
	d7	Enable skip defrost	0	--	0	1	0: NO; 1: YES	R/W
	dn	Nominal defrost duration for skip defrost	45	min	0	240		R/W
Dcc02	do	Number of defrosts to be performed when starting before activating skip def.	7	--	1	9		R
	dA1	Probe used for Running Time	0	--	0	1	0: DEFROST 1: TEMPSAT.EVAP.	R/W
	d11	Running Time temperature set point	-4.0 (24.8)	°C (°F)	-50.0 (-58.0)	30.0 (86.0)		R/W
	d10	Defrost duration in Running Time mode	0	min	0	240	0 = DISABLED	R/W
Dcc03	dA2	Delay at start-up before activating Running Time	120	min	0	480		R
	ddt	Additional temperature for power defrost	0.0 (0.0)	°C (°F)	-20.0 (-36.0)	20.0 (36.0)		R/W
Dcc04	ddP	Additional defrost duration in power defrost	0	min	0	60		R/W
	dS0	Enable Sequential Stops	0	--	0	1	0: NO; 1: YES	R
	dS1	Compressor ON time for Sequential Stop defrost	180	min	0	999		R/W
	dS2	Compressor OFF time for sequential Stop defrost	10	min	0	999		R/W

Mask index	Par.	Description	Default	UOM	Min	Max	Possible value descr.	R/W
Dd01	F0	Configure fan management	0	--	0	2	0: ALWAYS ON 1: BY SV-SD DIFFERENCE 2: BY DEFROST TEMP.	R/W
	F1	Fan activation threshold	-5.0 (23.0)	°C (°F)	-50.0 (-58.0)	50.0 (122.0)		R/W
	F2	Enable fans off with controller off (OFF)	0	--	0	1	0: NO; 1: YES	R/W
Dd02	F3	Enable fans off during defrost	0	--	0	2	0: ALWAYS ON 1: ALWAYS OFF 2: ALWAYS ON, OFF IN dd	R/W
	Fd	Fan off time in post-dripping	60	s	0	240		R/W
	Frd	Fan differential	2.0 (3.6)	°C (°F)	0.1 (0.2)	20.0 (36.0)		R/W
Dd03	F6	Maximum fan speed	80	%	min	100		R/W
	F7	Minimum fan speed	10	%	0	max		R/W
Dd04	F5	Fan cut-off temperatures	0.0 (32.0)	°C (°F)	-50.0 (-58.0)	50.0 (122.0)		R/W
	F8	Fan peak time	10	s	0	240		R/W
	F9	Override fan output to 100% every:	0	min	0	240		R/W
De01	rHo	Anti-sweat modulation offset from dew point	2.0 (3.6)	°C (°F)	-20.0 (-36.0)	20.0 (36.0)		R
	rHd	Anti-sweat heater differential modulation	0.0 (0.0)	°C (°F)	0.0 (0.0)	20.0 (36.0)		R/W
De02	rHB	Anti-sweat modulation cut-off	10.0 (18.0)	°C (°F)	0.0 (0.0)	20.0 (36.0)		R/W
	rHC	Anti-sweat heater modulation cut-off differential	1.0 (1.8)	°C (°F)	0.0 (0.0)	10.0 (18.0)		R/W
De03	rHt	Anti-sweat heater activation period	30	min	10	180		R/W
	rHu	Manual activation anti-sweat heaters percentage	70	%	0	100		R/W
De04	rH6	Minimum anti-sweat heater output	10	%	0	max		R
	rH7	Maximum anti-sweat heater output	100	%	min	100		R/W
De05	rH8	Type of anti-sweat heater modulation	0	--	0	1	0: P; 1: P+I	R/W
	rH9	Anti-sweat heater integral time	60	s	0	999		R/W
De06	Ga	Coefficient a" for glass temperature formula	2.0 (3.6)	°C (°F)	-20.0 (-36.0)	20.0 (36.0)		R/W
	Gb	Coefficient b" for glass temperature formula	22	%	0	100		R/W
De07	Gc	Coefficient c" for glass temperature formula	80	%	0	100		R/W
Df01	bA1	Showcase/cold room cleaning duration	15	min	0	60		R/W
Ea01	H0	Serial address for supervisor (BMS)	194	--	0	199		R/W
	H6	BMS communication speed	4	--	0	4	0: 1200 BAUD 1: 2400 BAUD 2: 4800 BAUD 3: 9600 BAUD 4: 19200 BAUD	R
	H7	BMS communication protocol	0	--	0	2	0: CAREL 1: MODBUS 2: WINLOAD 3: MODEM GSM 4: RS232	R
Ea02		Modbus master protocol baud rate	4	--	0	4	0: 1200 1: 2400 2: 4800 3: 9600 4: 19200	R/W
		Modbus master protocol Stop bits	1	--	0	1	0: 1; 1: 2	R/W
		Modbus master protocol parity	0	--	0	2	0: NO 1: EVEN 2: ODD	R/W
		Timeout	500	ms	100	5000		
Ea03		Master/Slave unit address	1	--	1	6	1: MASTER 2: SLAVE 1...6; SLAVE 5	R/W
Eb01		Multi-evaporator unit with single compressor	0		0	1	0: NO; 1: YES	R/W
Eb02	Sn	Number of slaves	0	--	0	5		R/W
Eb03	PE1	Number of evaporators (for multi-evaporator)	1	--	1	6		R/W
	PES	Enable modulating superheat	0	--	0	1	0: NO; 1: YES	W
Eb04	PE2	Evaporator capacity	500	W	0	15000		R/W
Eb05	PE5	Multi-evaporator superheat control proportional gain	4.0	--	1.0	99.9		R/W
	PE6	Multi-evaporator superheat control integral time	120	s	0	999		R/W
	PE7	Multi-evaporator superheat control offset	20.0 (36.0)	°C (°F)	0.0 (0.0)	40.0 (72.0)		R/W
Eb06	PEA	Change unit delay in SuperHeat mode	180	s	0	999		R/W
	PEB	Modulating SuperHeat mode	0	--	0	1	0: BEST UNIT; 1: ALL	R/W
Eb07	PEV	Valve opening during oil recovery	80	%	0	100		R/W
Ec01	/7	Type of showcase display	0	--	0	1	0: PLD WITH BUTTONS 1: PLD DISPLAY	R/W
	/t2	Value shown on showcase display	12	--	0	13	0: NONE 1: U01 2: U02 3: U03 4: U04 5: U05 6: U06 7: U07 8: U08 9: U09 10: U10 11: REGULATION PROBE 12: VIRTUAL PROBE 13: SETPOINT	R/W
Ec02	/t	Enable show alarms on showcase display	1	--	0	1	0: NO; 1: YES	R/W
	d6	Display management during defrost	0	--	0	2	0: VALUE TEMP. AND DEF 1: VALUE TEMP. FROZEN 2: ALWAYS DEF	R
	H4	Enable buzzer	1	--	0	1	0: NO; 1: YES	R/W
Ec03	Ut	Temperature unit of measure	0	--	0	1	0: °C; 1: °F	R/W
	UP	Pressure unit of measure	0	--	0	1	0: BARG 1: PSIG	R/W
Ec04		Select language used on pGDe	1	--	1	2	0: ITALIAN 1: ENGLISH	R/W

Mask index	Par.	Description	Default	UOM	Min	Max	Possible value descr.	R/W
Ed02		Clock "hour" setting	0	h	0	23		R/W
		Clock "minutes" setting	0	--	0	59		R/W
		Clock "day" setting	0	--	1	31		R/W
		Clock "month" setting	0	--	1	12		R/W
		Clock "year" setting	0	--	0	99		R/W
		Read current day of the week	0	--	0	0	0: *** 1: MONDAY 2: TUESDAY 3: WEDNESDAY 4: THURSDAY 5: FRIDAY 6: SATURDAY 7: SUNDAY	R
Ee01	Y0	User password	000	--	0	999		R/W
	Y1	Service password	123	--	0	999		R/W
	Y2	Manufacturer password	123	--	0	999		R/W
Ee02	PP	Login Password	0	--	0	999		R/W
Ee03	PD	Menu access time without re-entering password	15	min	0	90		R/W
Ef01	Y3	Install Carel default parameters	0	--	0	1	0: 1: DEFAULT. INSTALLATION	R/W
Ef02		Save configuration	0	--	0	1	0: 1: SAVE	R/W
Fc01	Aa	Select probe for high and low temperature alarm Al.1	1	--	0	9	0: VIRTUAL PROBE 1: OUTLET PROBE 2: DEFROST PROBE 3: INTAKE PROBE 4: SUCTION PROBE 5: SATURATION PROBE 7: AUX.1 PROBE 8: AXU.2 PROBE 9: TEMP.DEWPPROBE	R/W
	AH	High temperature alarm threshold Al.1	10.0 (50.0) 10.0 (18.0)	°C (°F)	-50.0 (-58.0) 0.0 (0.0)	50.0 (122.0) 50.0 (90.0)	if A1= 1: ABSOLUTE if A1= 0: RELATIVE	R/W
	AL	Low temperature alarm threshold Al.1	4.0 (39.2) 4.0 (7.2)	°C (°F)	-50.0 (-58.0) 0.0 (0.0)	50.0 (122.0) 50.0 (90.0)	if A1= 1: ABSOLUTE if A1= 0: RELATIVE	R/W
	A1	Type of alarm thresholds, relative to control set point or absolute	0	--	0	1	0: RELATIVE 1: ABSOLUTE	R/W
	Fc02	A0	Temperature alarm differential	2.0 (3.6)	°C (°F)	0,1.0 (0,18.0)	20.0 (36.0)	
Fc03	Ad	High and low temperature alarm delay	120	min	0	240		R/W
	Ar	Enable alarm propagation from Slaves to Master	0	--	0	1	0: NO; 1: YES	R/W
Fc04	A7	Delay time for delayed external alarm	1	min	0	240		R/W
	Aa2	Select probe for high and low temperature alarm Al.2	0	--	0	9	0: VIRTUAL PROBE 1: SOUTLET PROBE 2: DEFROST PROBE 3: INTAKE PROBE 4: SUCTION PROBE 5: SATURATION PROBE 7: AUX.1 PROBE 8: AXU.2 PROBE 9: TEMP.DEWPPROBE.	R/W
Fc04	AH2	High temperature alarm threshold Al.2	10.0 (50.0) 10.0 (18.0)	°C (°F)	-50.0 (-58.0) 0.0 (0.0)	50.0 (122.0) 50.0 (90.0)	se A1= 1: ABSOLUTE se A1= 0: RELATIVE	R/W
	AL2	Low temperature alarm threshold Al.2	4.0 (39.2) 4.0 (7.2)	°C (°F)	-50.0 (-58.0) 0.0 (0.0)	50.0 (122.0) 50.0 (90.0)	se A1= 1: ABSOLUTE se A1= 0: RELATIVE	R/W
	A2	Type of alarm thresholds, relative to control set point or absolute	0	--	0	1	0: RELATIVE 1: ABSOLUTE	R
Fc05	AdE	Alarm delayed external delay priority	0	--	0	1	0: LOW 1: HIGH	R/W
	As	Serial probe alarm delay	30	min	10	500		R/W
Fd00	rF	Reset alarm log	0	--	0	1	0: NO; 1: YES	R/W

Tab. 7.b



These parameters should not be selected, depending on the compressor model. Their modification could compromise the compressor-life, as they are agreed with the manufacturer. For any setting, contact Carel.

8. SIGNALS AND ALARMS





Heos can manage both alarms relating to the status of the digital inputs and to system operation. For each alarm, the following are controlled:

- actions on the devices, if required
- output relays
- red LED on the terminal and buzzer
- any activation delay

The complete list of alarms, with the related information as described above, is available in the "Alarm table".

8.1 Alarm management

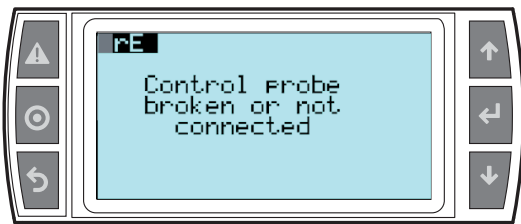

All alarms feature the following behaviour:

- When an alarm is activated, the red LED flashes and the buzzer and alarm relay are activated (when configured)
- Pressing the  button, the red LED stays on steady, the buzzer is muted and the alarm screen is shown
- If there is more than one active alarm, these can be scrolled using  and 
- Pressing the  button again for at least 3 seconds manually resets the alarms, which are cleared from the display unless others are active (they are saved in the log)



Reset

Alarms can be reset manually or automatically:

- Manual: the alarm is reset by pressing the  button twice, the first time displays the corresponding alarm screen and mutes the buzzer, the second (extended, for at least 3 seconds) cancels the alarm (which is saved in the log). If the alarm is still active, the reset has no effect and the signal is shown again.
- Automatic: when the alarm condition ceases, the alarm is automatically reset, the LED comes on steady and the corresponding screen remains displayed until the  button is pressed and held; the alarm is saved in the log.

For manual reset, the functions associated with the alarm will not be reactivated until the alarm is reset, while for automatic reset, the functions are reactivated as soon as the alarm condition ceases.

Log

The alarm log can be accessed:

- from branch F.d of the main menu
- pressing  and then  when there are no active alarms

The alarm log screens show:

1. the chronological number of the event (no. 01 is the oldest alarm)
2. time and date of the alarm
3. the alarm code (see the table in par. 8.5)
4. short description of the logged alarm
5. control probe reading and set point, superheat reading and set point, discharge temperature value, envelope zone, evaporation and condensing pressure values converted to temperature.

The last screen displayed is used to reset the log.

 **Note:** A maximum of 50 alarms can be logged; after this limit any new events overwrite the oldest ones, which are therefore deleted.

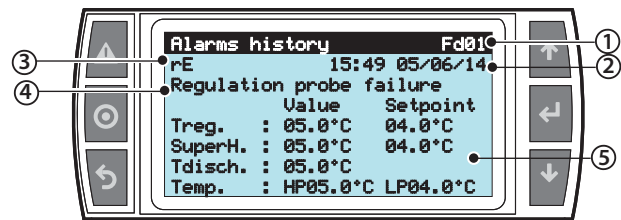

8.2 Compressor alarms

The compressor high and low pressure alarms can be set in branch Dad01-04. In addition to the high and low pressure alarm thresholds, with corresponding delays for the low pressure alarms, this screen can also be used to set the type of reset when exiting the envelope. For the delay and type of reset, also see the alarm table (par. 8.5).

8.3 EEV valve protector alarms

The alarms corresponding to the LowSH, LOP, MOP and High Tcond protectors are only activated during control when the corresponding activation threshold is exceeded, and only when the timeout defined by the corresponding parameter has elapsed. If a protector is not enabled (integration time= 0 s), no alarm will be signalled. If before the expiry of the timeout, the protector control variable returns back inside the corresponding threshold, no alarm will be signalled.

 **Note:** this is a likely event, as during the timeout, the protection function will have an effect.

If the timeout relating to the control alarms is set to 0 s, the alarm is disabled. The protectors are still active, however. The alarms are reset automatically.

8.4 Temperature alarms

Assign probe for high and low temperature alarms (parameters Aa, Aa2)

Aa selects the probe to be used for measuring the high and low temperature alarms with reference to thresholds AL and AH. Aa2 is the same as Aa for thresholds AL2 e AH2.

Par	Description	Def	Min	Max	UM
Aa	Assign probe for high (AH) and low (AL) temperature alarm 0: VIRTUAL PROBE 1: OUTLET PROBE 2: DEFROST PROBE 3: INTAKE PROBE 4: SUCTION PROBE 5: SATURATED PROBE 7: AUX. PROBE 1 8: AUX. PROBE 2 9: DEWP. TEMP. PROBE	1	0	9	-
Aa2	Assign probe for high (AH2) and low (AL2) temperature alarm - see Aa	0	0	9	-

Tab. 8.a

Alarm parameters and activation

AL (AH) is used to determine the activation threshold for the low (high) temperature alarm LO (HI). The value set for AL (AH) is continuously compared against the value measured by the probe defined by parameter AA. Parameter Ad represents the alarm activation delay, in minutes; the low temperature alarm (LO) is activated only if the temperature remains below the value of AL for a time greater than Ad. The thresholds may be relative or absolute, depending on the value of parameter A1. In the former case (A1=0), the value of AL indicates the deviation from the set point and thus the activation point for the low temperature alarm is: set point - AL. If the set point changes, the activation point also changes automatically. In the latter case (A1=1), the value of AL indicates the low temperature alarm threshold. The low temperature alarm is signalled by the buzzer and error code LO on the display. The same applies to the high temperature alarm (HI), with AH instead of AL. I

The meaning of parameters AL2, AH2, Aa2 and A2 is similar to AL, AH, Aa, A1, relative to the second set point.

Par	Description	Def	UM	Min	Max
AH	High temperature alarm threshold AI.1	10.0	°C	-50.0	50.0
		(50.0)	(°F)	(-58.0)	(122.0)
AL	Low temperature alarm threshold AI.1	10.0	°C	0.0	50.0
		(18.0)	(°F)	(0.0)	(90.0)
AL	Low temperature alarm threshold AI.1	4.0	°C	-50.0	50.0
		(39.2)	(°F)	(-58.0)	(122.0)
A1	Type of alarm thresholds, relative to the control set point or absolute 0: RELATIVE 1: ABSOLUTE	0	--	0	1
A0	Temperature alarm differential	2.0	°C	0.1	20.0
		(3.6)	(°F)	(0.2)	(36.0)
Ad	High and low temperature alarm delay	120	min	0	240
Ar	Enable propagation of alarms from Slaves to Master 0: NO; 1: YES	0	--	0	1
A7	Delay time for delayed external alarm	1	min	0	240
AH2	High temperature alarm threshold AI.2	10.0	°C	-50.0	50.0
		(50.0)	(°F)	(-58.0)	(122.0)
AL2	Low temperature alarm threshold AI.2	10.0	°C	0.0	50.0
		(18.0)	(°F)	(0.0)	(90.0)
AL2	Low temperature alarm threshold AI.2	4.0	°C	-50.0	50.0
		(39.2)	(°F)	(-58.0)	(122.0)
A2	Type of alarm thresholds, relative to the control set point or absolute 0: RELATIVE 1: ABSOLUTE	0	--	0	1
AdE	Delayed external alarm delay priority 0: LOW (compressor not stopped) 1: HIGH (compressor stopped)	0	--	0	1
As	Serial probe alarm delay	30	min	10	500

Tab. 8.b

Note:

- alarms LO(LO2) and HI(HI2) have automatic reset. A0 represents the hysteresis between the alarm activation value and deactivation value.

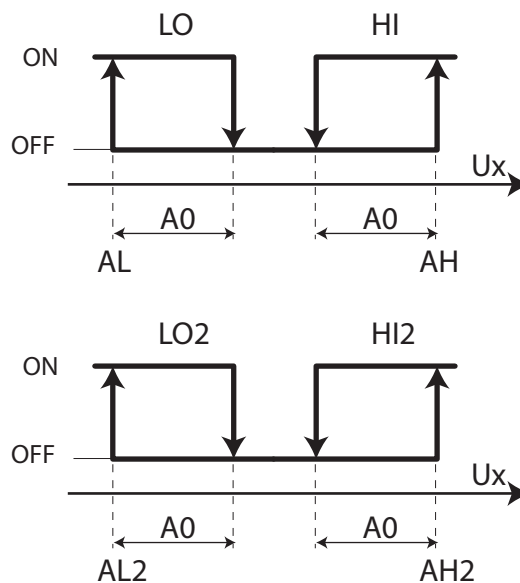



Fig. 8.a

Key

- LO, LO2 Low temperature alarms
- HI, HI2 High temperature alarms
- Ux Probes selected

8.5 Alarm table

Code	Description	Log	Reset	Delay	Alarm relay	Action
rE	Control probe broken or disconnected	x	Auto	Imm.	ON	
SLP	Serial probe broken or disconnected	x	Auto	Imm.	ON	
EA	Outlet probe broken or disconnected	x	Auto	Imm.	ON	Safety control
Eb	Defrost probe 1 broken or disconnected	x	Auto	Imm.	ON	
Ec	Air intake probe broken or disconnected	x	Auto	Imm.	ON	Safety control
EG	Auxiliary probe 1 broken or disconnected	x	Auto	Imm.	ON	
EH	Auxiliary probe 2 broken or disconnected	x	Auto	Imm.	ON	
EI	Humidity probe t broken or disconnected	x	Auto	Imm.	ON	
EL	Temperature probe to calc. dew point broken or disconnected	x	Auto	Imm.	ON	
EM	Glass temperature probe broken or disconnected	x	Auto	Imm.	ON	
IA	Immediate external alarm	x	Auto	Imm.	ON	Compressor OFF
dA	Delayed external alarm	x	Auto	A7	ON	Compressor OFF
Lo	Low temperature alarm	x	Auto	Ad	ON	
Lo2	Low temperature alarm 2	x	Auto	Ad	ON	
HI	High temperature alarm	x	Auto	Ad	ON	
HI2	High temperature alarm 2	x	Auto	Ad	ON	
Ed1	Defrost ended after maximum time		Auto	Imm.	OFF	
MOP	MOP alarm	x	Auto	PM3	ON	Compressor OFF
LOP	LOP alarm	x	Auto	PL3	ON	Compressor OFF
LSh	Low superheat alarm	x	Auto	P9	ON	Compressor OFF
HSh	High SH temperature alarm	x	Auto	Pb	ON	
tC	RTC invalid or flat battery		Auto	-	ON	
MA	Communication lost with Master		Auto	15s	OFF	
u1	Communication lost with Slave 1		Auto	15s	OFF	
u2	Communication lost with Slave 2		Auto	15s	OFF	
u3	Communication lost with Slave 3		Auto	15s	OFF	
u4	Communication lost with Slave 4		Auto	15s	OFF	
u5	Communication lost with Slave 5		Auto	15s	OFF	
n1	Alarm on Slave 1		Auto	15s	OFF	
n2	Alarm on Slave 2		Auto	15s	OFF	
n3	Alarm on Slave 3		Auto	15s	OFF	
n4	Alarm on Slave 4		Auto	15s	OFF	
n5	Alarm on Slave 5		Auto	15s	OFF	
dr	Door open timeout		Auto	d8	OFF	Fans ON
LSA	Low suction temperature alarm (*)	x	Auto	P12	ON	Compressor OFF
Mnt	Crt Cold room maintenance timeout		Auto	Imm.	OFF	
UI	Power+ device no. offline	x	Auto	Imm.	ON	Compressor OFF
GAI	UIE Power+ no (*)	x	A19	Imm.	ON	Compressor OFF
ISF	Failed compressor start (att.: / max.:) (*)		Auto	Imm.	ON	
AEI	Envelope zone alarm (*)	x	A18	Imm.	ON	Compressor may stay OFF if occurs more than once in set time
Hid	High discharge temperature (*)	x	Auto	Imm.	ON	See AI_Envelop
dLP	Low pressure differential (insufficient lube) (*)	x	A18	Imm.	ON	See AI_Envelop
Pnr	Power+ not recognised		Auto	Imm.	OFF	Compressor does not start
LP	Low pressure alarm (*)	x	A17	Imm.	ON	Compressor OFF
HP	High pressure alarm (*)	x	A17	Imm.	ON	Compressor OFF
ELP	Suction pressure probe S1 alarm	x	Auto	Imm.	ON	Compressor OFF
ESt	Suction temperature probe S2 alarm	x	Auto	Imm.	ON	Compressor OFF
EHP	Discharge pressure probe S3 alarm	x	Auto	Imm.	ON	Compressor OFF
Edt	Discharge temperature probe S4 alarm	x	Auto	Imm.	ON	Compressor OFF
LqP	Liquid probe broken or disconnected	x	Auto	Imm.	ON	
WP	HiP Water inlet probe broken or disconnected	x	Auto	Imm.	ON	
WoP	HoP Water outlet probe broken or disconnected	x	Auto	Imm.	ON	
dtA	Low Power + driver temperature	x	Auto	Imm.	ON	Compressor OFF
VPA	Valve position warning	x	Auto	Pb2	OFF	
LCA	Low refrigerant charge warning	x	Auto	Pb4	OFF	

 **Note:** in the event of alarms, the evaporator fan behaves as set (with control active) for parameter F2 (screen Dd01).

(*) Manual or semi-automatic reset

9. SOFTWARE UPDATE

9.1 Setting the controller's address

The controller's pLAN address set by default in the factory is 1. The controller's address can be set via a terminal connected in the pLAN network. The controller is assigned a private (Pr) or shared (Sh) terminal with address 32. The address of the external terminal can be set in the range between 0 and 32; addresses between 1 and 32 are used by the pLAN protocol, while address 0 identifies the Local terminal protocol, used for point-to-point connections and to configure the controller (this procedure is only possible with a pGD terminal and one pCO only).

If the controller with the default setting (address=1) is connected to an external terminal (address=32), communication is established and the display on the external terminal replicates the display on the built-in terminal, if featured. If, on the other hand, the controller has a different address (e.g. 7) and the terminal is not set to communicate with the controller with this address, once the connection has been established, the terminal displays a blank screen. In this case, proceed as follows.

Procedure:

1. Press the UP, DOWN and Enter buttons together to access the screen for setting the terminal's address.



2. Set the address of the display, 0 for point-to-point connections. Confirm by pressing Enter.

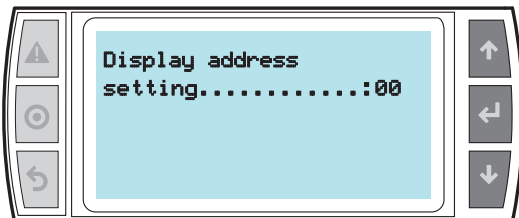

3. Power off the controller.

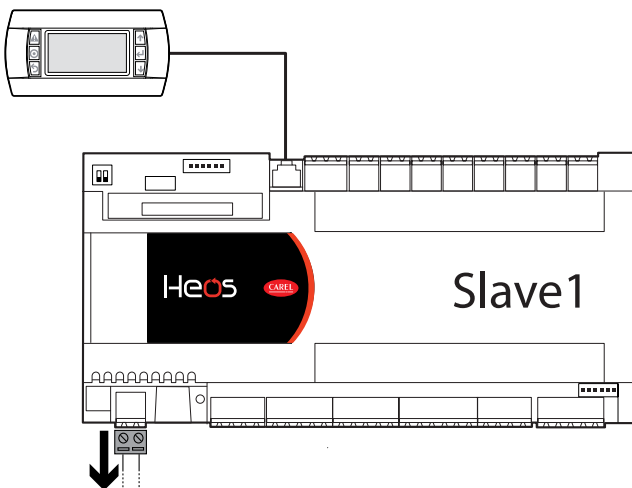
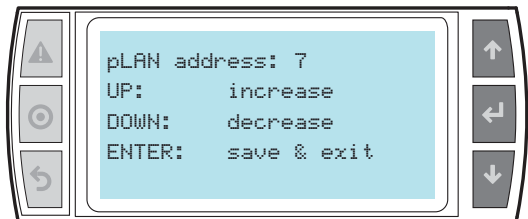

Fig. 9.a

4. Power on the controller while holding the Alarm and Up buttons together, until the following screen is shown.



5. Use UP and DOWN to set the controller's pLAN address to 7 and confirm by pressing Enter.



9.2 Setting the terminal's address and connecting the controller to the terminal

After setting the controller's network address (see previous paragraph), to establish connections between the controller and the terminal, the terminal's address needs to be set.

Procedure:

1. Press the UP, DOWN and Enter buttons together. The screen is displayed for setting the terminal's address. Set the address to 2 and confirm by pressing Enter.

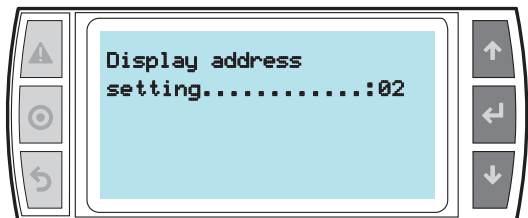

2. Press the UP, DOWN and Enter buttons together. Press Enter twice and set the controller's address to 7. Confirm by pressing Enter.



3. Confirm by pressing Enter.

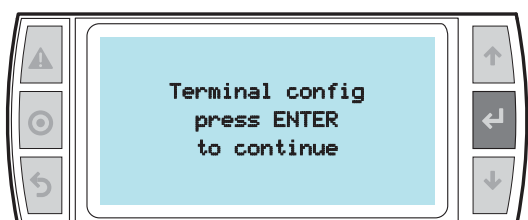

- Set terminal 1 (Trm1) with address 2 as private (Priv) or shared (Shared) according to the application, and confirm to exit. After a few seconds, the connection will be established.

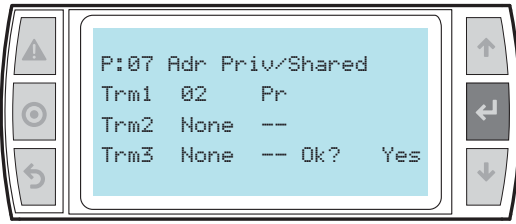

- To add a second terminal, repeat steps 1 to 4.

9.3 Uploading/updating the software

The following methods can be used to update the firmware and acquire the log files on pCO controllers:

- SmartKey programming key;
- pCO manager tool, installable on a PC.

Smart key

The PCOS00AKY0 key is an electronic device used to program and service the pCO sistema family controllers. PCOS00AKY0 simplifies data transfer between the controllers installed and a personal computer by exploiting the high capacity flash memory for storing software applications, BIOS and variable logs. The pCO is connected directly via the telephone connector using the cable supplied, while to transfer the data to a personal computer, the USB adapter code PCOS00AKC0 is required. The power supply comes either via the USB port on the PC or from the controller, therefore no external power supply is needed.

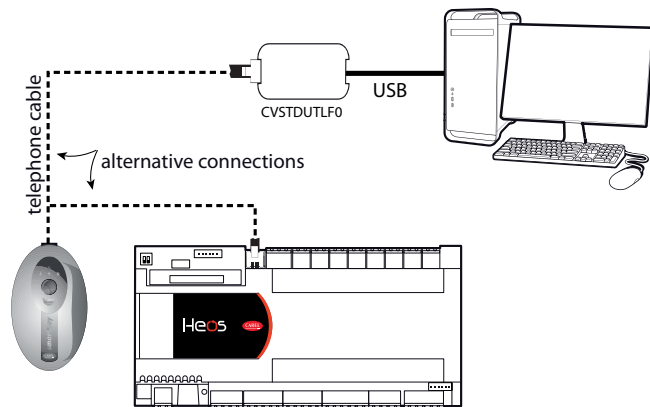

Fig. 9.b

For the steps in the procedure, see par. 9.1.

Operating instructions

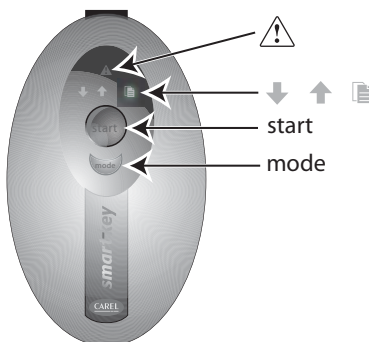

Fig. 9.c

Programming the Smart Key via Personal Computer

The operating modes described in the table below can be configured using a program on the PC. The program can also load the software to the key or transfer logged data from the controller to disk.

Type	Function	Mode button
B	Update software from key to pCO (BIOS, application, parameters, etc.)	Disabled
C*	Copy software from pCO to pCO (BIOS, application, parameters, etc.)	Switches the key from write mode to read mode
D	Read logs	Disabled
E	Read logged data and software from pCO (BIOS, application, parameters, etc.)	Disabled
F	Read logged data	Disabled
G	Copy from pCO to pCO and read logs	Switches the key to write mode, read mode and read logs mode

*: Default mode

Tab. 9.c

The key is factory-programmed in read/write mode (type C) so that it can be used immediately to transfer software from one controller to another. When the key is connected to the personal computer, the symbols have the following meanings:

↑ ↓	Flashing	Waiting for connection to PC
↑ ↓	Alternating	When connected to PC indicates data transfer in progress

The programming key is compatible starting from BIOS version 3.43 and BOOT version 3.01. For more detailed information on programming the key, see the pCO Manager program manual.

Using the Smart Key with the pCO/μPC

Switch off the pCO, remove any peripherals connected in the pLAN and plug the key into the telephone connector on the controller. When switching on again, all the symbols light up momentarily and the buzzer emits a beep. A few seconds later the key becomes operational. During this period the symbols ↑ ↓ will flash. The controller then enters programming mode and the start button lights up steadily. Press the button to start data transfer.

Important:

- If the key is type B, C or G (in write mode) pressing the start button will immediately delete the software already loaded on the pCO.
- Do not remove the key while data is being transferred to the key itself, as the file being transferred will be lost and the corresponding space will not be restored. To restore the original capacity all the files will need to be deleted. If the key is type "C" or "G", simply perform a new application read operation.

Meanings of Buttons/Symbols

↑ ↓	Flashing: the key is connecting to the pCO. During this phase, which may last a few seconds, the start button is disabled.
start	Flashing: The key has detected the pCO and is checking the access rights.
start+ ↑	On steady: Pressing the start button will start writing the software to the pCO.
start+ ↓	On steady: Pressing the start button will start reading the software from the pCO.
start+ 📄	On steady: Pressing the start button will start reading the logs from the pCO.
mode	On steady: In case of C or G keys, pressing the button for 1 second switches from read to write.

Tab. 9.a

If the key is type C or G, pressing the "mode" button for 1 second switches from read to read logs (G only) or to write. The symbols ↑ (write to pCO), ↓ (read from pCO), 📄 (read logs) reflect the selected status. If the key is not type "C" or "G", the "mode" button is disabled and off. The "start" button starts the read or write operation, indicated by the flashing of the corresponding symbol (↑ or ↓) at a frequency proportional to the progress of the operation.

When the operation is completed, the buzzer will sound intermittently for 2 seconds. Pressing the start button again will make the buzzer sound without repeating the operation. To repeat the operation, the key must first be unplugged. In case of error the symbol will light up together with the other LEDs. The following table can help you find the cause of the problem.

Errors before pressing the START button

+ +	Symbols flashing	Communication error: No response from the pCO or: Key firmware version is incompatible
+mode	Symbols steady	Password error
+mode	Symbols flashing	Type of key is incompatible
+	Symbols steady	The key is missing one or more required files (memory empty; no kit for the type of pCO connected)
+ +start	Symbols steady + flashing start	Incompatibility between the software on the key and the pCO HW
+ +mode	Symbols steady + flashing mode	Incompatibility between pCO application and HW (application size)
+ +	Symbols steady	No logged data present on the pCO
	Steady	Type of key not programmed.

Tab. 9.d

Errori dopo la pressione del tasto START

+start+ +buzzer	Symbols flashing and buzzer sounding intermittently	Write operation failed
+start+ +buzzer	Symbols flashing and buzzer sounding intermittently	Read operation failed
+start+ +buzzer	Symbols flashing and buzzer sounding intermittently	Read logs operation failed
+ +	Symbols steady + flashing	Incompatibility between log configuration and pCOHW (no flash memory). This error does not prevent writing other files.
+	Steady	Insufficient space to read logs
	Flashing	Generic error

Tab. 9.e

9.4 pCO Manager: operating instructions

pCO Manager is a program that lets you manage all the configuration, debugging and maintenance operations on pCO Sistema devices. pCO Manager can be installed by itself or as part of the ITool programming environment.

Installing pCO Manager

Go to <http://ksa.carel.com> and, in section pCO Sistema, select pCO_manager. After you accept the general conditions of the software's free use licence, a window will open from which you can download the file pCO_manager.zip. Install the program on your computer.

Connecting the PC to the pCO controller

Connect a cable with USB/RS485 converter to the USB port on the computer, and connect the converter to a telephone cable plugged into the pLAN port of the pCO.

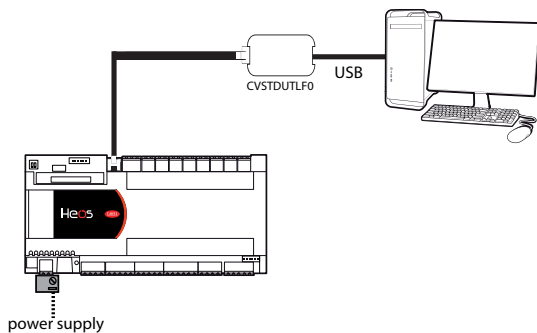

Fig. 9.d

Upon launching, pCO Manager will display a screen showing the connection settings in the upper right-hand corner. Choose:

1. "connessione locale" [local connection];
2. baud rate: Auto;
3. "ricerca dispositivo" [find device]: Auto (pLAN).

As for the port number, follow the Wizard's instructions for the port to be identified automatically (e.g. COM4).

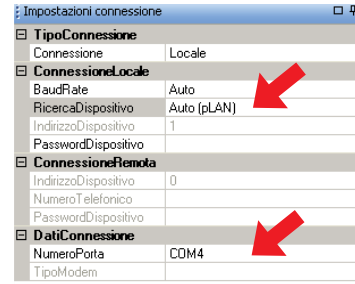

Fig. 9.e

Switch the controller off and then on again and use the Connect command to establish the connection. When the connection is established the flashing message "ONLINE" will appear at the bottom left of the screen.



Fig. 9.f

Installing the application program

- Select the directory containing the application program files and click "Upload" to upload the program to the pCO controller.

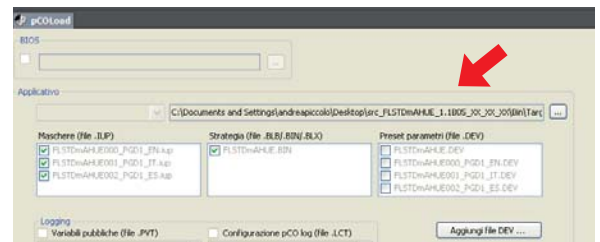

Fig. 9.g

Commissioning

- Using the mouse, select "Commissioning" at the bottom left. A new work environment will appear.

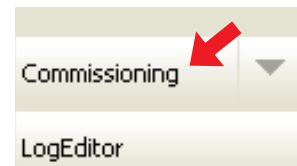

Fig. 9.h

- Click on "configura dispositivo" [configure device] to display all the application variables. The variables can be selected according to the categories that appear at the bottom.



Fig. 9.i

Changing a parameter

Select the parameter category and then the parameter that you want to edit. The parameter (e.g. recovery.recovery_type) will be highlighted in blue.

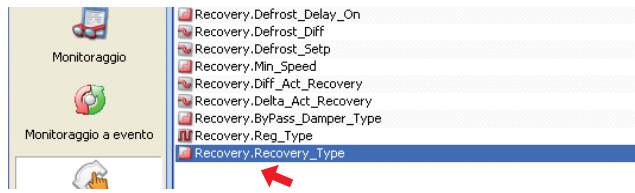

Fig. 9.j

1. Double-click on the column marked "letto" [read]. A window will appear in which you can enter the new value for the parameter.

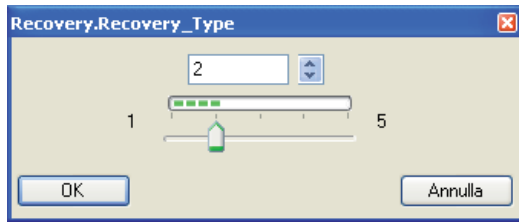

Fig. 9.k

2. Enter the new value (e.g. 3) and click OK. The new value will appear in the column marked "scritto" [written]. To write the parameter to the pCO controller, right-click and select "scrivi selezionate" [write selected]. The new value will appear in the column marked "scritto" [written], meaning that the parameter has been written to the controller.

Default	Letto		Scritto
120	120	✓	120
1	1	✓	1
5,0	5,0	✓	5,0
60	60	✓	60
3,0	3,0	✓	3,0
0	0	✓	0
100	100	✓	100
120	120	✓	120
4,0	4,0	✓	4,0
-1,0	-1,0	✓	-1,0
20	20	✓	20
0,3	0,3	✓	0,3
0,5	0,5	✓	0,5
1	1	✓	1
0	0	✓	0
1	3	✓	3



Fig. 9.l

Click on "Salva" [Save] to generate the project's ".2cw" file.

Commissioning: basic concepts

Note: The following paragraphs are from the online help of pCO Manager, to which the user is referred for further details.

Commissioning is a configuring and real-time monitoring software that can be used to supervise the performance of an application program installed on a pCO, to start up the pCO and to perform debugging and maintenance. With this software the user can set the configuration parameters, edit the values of volatile and permanent variables, save on file the trends of the unit's main quantities, manually manage the unit's I/O using simulation files and monitor/reset the alarms of the unit on which the device is installed.

Work carried out with Commissioning is preceded by configuring the work environment, which is typically done by the project designer. The active project in 1Tool is automatically loaded by pCO Manager.

The project designer can use the configuration functions of Commissioning to decide which variables should be subjected to monitoring, logging, trend-monitoring and event-monitoring, to organize variables into categories and to create sets of configuration parameters.

Operators using Commissioning for maintenance will be able to see the necessary variables and to draw from preset configuration values.

Support files

Once the design of the application is completed, 1Tool generates a number of files in the compiling stage, two of which are required by Commissioning:

- <nomeApplicativo>.2CF [<ApplicationName>.2CF] (variable descriptor)
- <nomeApplicativo>.2CD [<ApplicationName>.2CD] (category and access profile descriptor)

In addition to these files, the software also manages the <nome applicativo>.DEV [<Application Name>.DEV] file, which contains the unit's preset parameters. When the user has finished using Commissioning, whether for configuration or monitoring purposes, the following files can be generated:

- <nomeApplicativo>.2CW [<ApplicationName>.2CW] (descriptor for categories, access profiles, monitoring groups);
- <nomefileCommissioningLog>.CSV [<FilenameCommissioningLog>.CSV] (file used for the commissioning log, containing data of the variables logged during monitoring).

Therefore, to configure Commissioning the following files are required: .2CF, .2CD and, if necessary, the .DEV file, which can be imported or exported. For monitoring purposes, in addition to the files above, it might also be necessary to have the .2CW file, containing the definition of the work environment. The commissioning log file is a simple output file.

pCO Load: basic concepts

pCOLoad is the module that manages:

- uploading to the flash memory (of the device or of the ProgKeyX key installed on the pCO);
- uploading to the NAND memory of certain devices;
- downloading the log file, .DEV file and P memory (from the flash memory);
- downloading files from the NAND memory, if present.

The files exchanged with the Flash memories of pCO controllers are:

- BOOT.BIN (download reserved, upload enabled from menu)
- BIOS.BIN (download reserved)
- <nomeApplicativo>.BLB [<ApplicationName>.BLB] (download reserved)
- <nomeApplicativo>.BIN [<ApplicationName>.BIN] (download reserved)
- <nomeApplicativo>.DEV [<ApplicationName>.DEV]
- <nomeApplicativo>.GRT [<ApplicationName>.GRT] (upload only, from which the .GRP file is extracted)
- <nomeApplicativo>.IUP [<ApplicationName>.IUP]
- <nomeApplicativo>.LCT [<ApplicationName>.LCT]
- <nomeApplicativo>.PVT [<ApplicationName>.PVT]
- <nomepCOlog>.BIN, <nomepCOlog>.CSV, <nomepCOlog_GRAPH>.CSV [<pCOlogName>.BIN, <pCOlogName>.CSV, <pCOlog_GRAPHName>.CSV] (only if log files have been configured, download only).

The files exchanged with the NAND memories of pCO controllers are:

- any file that the pCO can independently copy to flash memory (see list);
- external files (e.g. .pdf or .doc files for documentation).

LogEditor: basic concepts

LogEditor is the module used to configure the log files of pCO devices (pCO logs). Configuring pCO logs consists in defining a number of sets of variables in which to specify which variables should be logged, the logging method (by frequency or by event) and the minimum number of loggings required. Configuration is based on a binary file (.PVT – Public Variable Table), which is generated by 1Tool and contains the descriptive data of the variables that can be logged.

All the log configurations so defined are saved in the .LCT (Log Configuration Table) binary file, which must be uploaded to the pCO together with the .PVT file. Log configuration data is also saved in a file that can be used only by LogEditor – the .LEF file, which must be saved to be edited with LogEditor as necessary.

LogEditor can be used even when the device is not connected. Once the files for logging are uploaded to the pCO, the pCO saves the logged data in the following files:

- .BIN file containing all the data in binary format;
- .CSV file containing the same data in a generic format with values separated by commas;
- *_GRAPH.CSV containing the same data to be used for charting purposes.

9.5 History of software revisions

New version 1.1

- Water- or air-cooled condenser control added
- Anti-sweat control added for water-cooled inverters
- Oil recovery management modified for multi-evaporator systems
- Pressure control added for ON/OFF compressors in multi-evaporator systems
- Control adapted for extension of envelope on Toshiba compressors

New version 1.2

- New warning
- Modify alarms management

CAREL

CAREL INDUSTRIES - Headquarters
Via dell'Industria, 11 - 35020 Brugine - Padova (Italy)
Tel. (+39) 049.9716611 - Fax (+39) 049.9716600
e-mail: carel@carel.com - www.carel.com

Agenzia / Agency: